

Precision Single, Dual and Quad Low Noise Operational Amplifiers

ISL28107, ISL28207, ISL28407

The ISL28107, ISL28207 and ISL28407 are single, dual and quad amplifiers featuring low noise, low input bias current, and low offset and temperature drift. This makes them the ideal choice for applications requiring both high DC accuracy and AC performance. The combination of precision, low noise, and small footprint provides the user with outstanding value and flexibility relative to similar competitive parts.

Applications for these amplifiers include precision active filters, medical and analytical instrumentation, precision power supply controls, and industrial controls.

The ISL28107 is available in 8 Ld SOIC, MSOP and TDFN packages. The ISL28207 is available in 8 Ld SOIC, MSOP and TDFN packages. The ISL28407 is available in a 14 Ld SOIC package. All devices are offered in standard pin configurations and operate over the extended temperature range of -40°C to +125°C.

Applications

- Precision instruments
- Medical instrumentation
- Spectral analysis equipment
- Active filter blocks
- Microphone pre-amplifier
- Thermocouples and RTD reference buffers
- Data acquisition
- Power supply control

Features

- Low input offset75µV Max.
- Input bias current 15pA
- Superb temperature drift
 - Voltage offset 0.65µV/°C Max.
 - Input current0.9pA/°C Max.
- Outstanding ESD performance
 - Human Body Model4.5kV
 - Machine Model 500V
 - Charged Device Model1.5kV
- Very low voltage noise, 10Hz 14nV/√Hz
- Low current consumption (per amp) 0.29mA Max.
- Gain-bandwidth product 1MHz
- Wide supply range4.5V to 40V
- Operating temperature range-40°C to +125°C
- No phase reversal
- Pb-free (RoHS compliant)

Related Literature

- See [AN1508](#) "ISL281X7SOICEVAL1Z Evaluation Board User's Guide"
- See [AN1509](#) "ISL282X7SOICEVAL2Z Evaluation Board User's Guide"

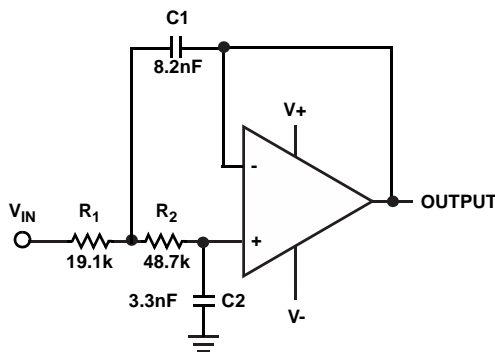

SALLEN-KEY LOW PASS FILTER (1kHz)
FIGURE 1. TYPICAL APPLICATION

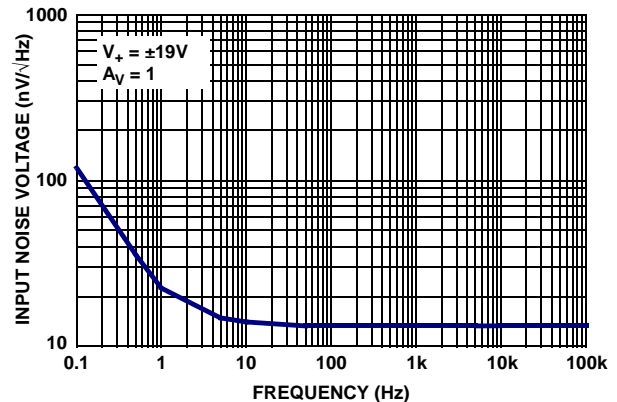

FIGURE 2. INPUT NOISE VOLTAGE SPECTRAL DENSITY

Table of Contents

Pin Configurations	3
Ordering Information	5
Absolute Maximum Ratings	6
Thermal Information	6
Operating Conditions	6
Electrical Specifications $V_S \pm 15V$	6
Electrical Specifications $V_S \pm 5V$	8
Typical Performance Curves	11
Applications Information	19
Functional Description	19
Operating Voltage Range	19
Input ESD Diode Protection	19
Output Current Limiting	20
Output Phase Reversal	20
Unused Channels	20
Power Dissipation	20
ISL28107, ISL28207, ISL28407 SPICE Model	20
License Statement	20
Characterization vs Simulation Results	23
Revision History	25
About Intersil	27
M8.15E	28
M8.15E	28
M8.118B	29
L8.3x3K	30
MDP0027	31

ISL28107, ISL28207, ISL28407

Pin Configurations

ISL28107
(8 LD SOIC, MSOP)
TOP VIEW

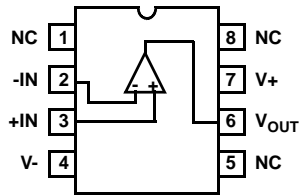

ISL28107
(8 LD TDFN)
TOP VIEW

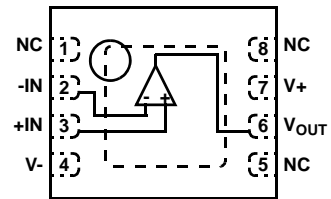

ISL28207
(8 LD SOIC, MSOP)
TOP VIEW

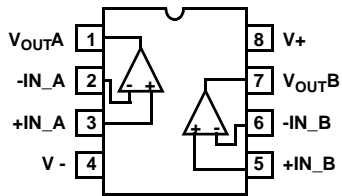

ISL28207
(8 LD TDFN)
TOP VIEW

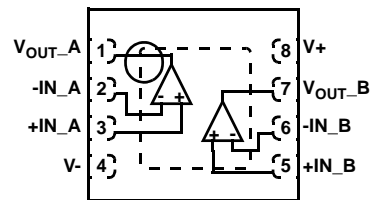

ISL28407
(14 LD SOIC)
TOP VIEW

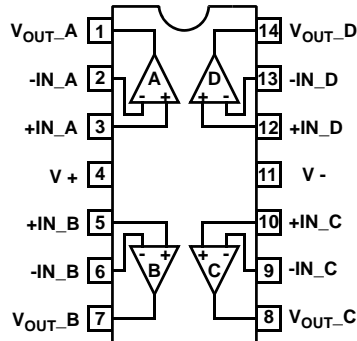

ISL28107, ISL28207, ISL28407

Pin Descriptions

ISL28107 (8 Ld SOIC, MSOP, TDFN)	ISL28207 (8 Ld SOIC, MSOP, TDFN)	ISL28407 (14 Ld SOIC)	PIN NAME	EQUIVALENT CIRCUIT	DESCRIPTION
3	-	-	+IN	Circuit 1	Amplifier non-inverting input
-	3	3	+IN_A		
-	5	5	+IN_B		
-	-	10	+IN_C		
-	-	12	+IN_D		
4	4	11	V-	Circuit 3	Negative power supply
2	-	-	-IN	Circuit 1	Amplifier inverting input
-	2	2	-IN_A		
-	6	6	-IN_B		
-	-	9	-IN_C		
-	-	13	-IN_D		
7	8	4	V+	Circuit 3	Positive power supply
6	-	-	V _{OUT}	Circuit 2	Amplifier output
-	1	1	V _{OUT_A}		
-	7	7	V _{OUT_B}		
-	-	8	V _{OUT_C}		
-	-	14	V _{OUT_D}		
1, 5, 8	-	-	NC	-	No internal connection
PD	PD	-	PD	-	Thermal Pad - TDFN and QFN packages only. Connect thermal pad to ground or most negative potential.

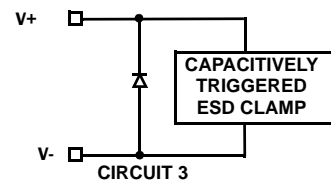
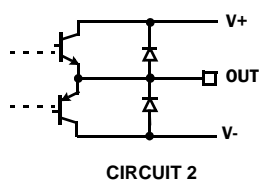
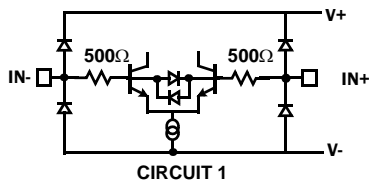

ISL28107, ISL28207, ISL28407

Ordering Information

PART NUMBER (Notes 1, 2, 3)	PART MARKING	TEMP. RANGE (°C)	PACKAGE (Pb-Free)	PKG. DWG. #
ISL28107FBZ	28107 FBZ	-40 to +125	8 Ld SOIC	M8.15E
ISL28107FUZ	8107Z	-40 to +125	8 Ld MSOP	M8.118B
ISL28107FRTZ	107Z	-40 to +125	8 Ld TDFN	L8.3x3K
ISL28207FBZ	28207 FBZ	-40 to +125	8 Ld SOIC	M8.15E
ISL28207FUZ	8207Z	-40 to +125	8 Ld MSOP	M8.118B
ISL28207FRTZ	8207	-40 to +125	8 Ld TDFN	L8.3x3K
ISL28407FBZ	28407 FBZ	-40 to +125	14 Ld SOIC	MDP0027
ISL28107SOICEVAL1Z	Evaluation Board			
ISL28207SOICEVAL2Z	Evaluation Board			

NOTES:

1. Add "-T*" suffix for tape and reel. Please refer to Tech Brief [TB347](#) for details on reel specifications.
2. These Intersil Pb-free plastic packaged products employ special Pb-free material sets, molding compounds/die attach materials, and 100% matte tin plate plus anneal (e3 termination finish, which is RoHS compliant and compatible with both SnPb and Pb-free soldering operations). Intersil Pb-free products are MSL classified at Pb-free peak reflow temperatures that meet or exceed the Pb-free requirements of IPC/JEDEC J STD-020.
3. For Moisture Sensitivity Level (MSL), please see device information page for [ISL28107](#), [ISL28207](#) and [ISL28407](#). For more information on MSL please see Tech Brief [TB363](#).

ISL28107, ISL28207, ISL28407

Absolute Maximum Ratings

Maximum Supply Voltage	42V
Maximum Differential Input Current	20mA
Maximum Differential Input Voltage	(V-) - 0.5V to (V+) + 0.5V
Min/Max Input Voltage	(V-) - 0.5V to (V+) + 0.5V
Max/Min Input Current for Input Voltage >V+ or <V-	±20mA
Output Short-Circuit Duration (1 Output at a Time)	Indefinite
ESD Tolerance	
Human Body Model	4.5kV
Machine Model (ISL28207 MSOP only)	300V
Machine Model	500V
Charged Device Model	1.5kV
ESD Tolerance (ISL28407 SOIC only)	
Human Body Model	6kV
Machine Model	450V
Charged Device Model	2kV

Thermal Information

Thermal Resistance (Typical)	θ_{JA} (°C/W)	θ_{JC} (°C/W)
8 Ld SOIC (ISL28107, Notes 4, 5)	120	60
8 Ld SOIC (ISL28207, Notes 4, 5)	105	50
8 Ld MSOP (ISL28107, Notes 4, 5)	155	50
8 Ld MSOP (ISL28207, Notes 4, 5)	160	55
8 Ld TDFN (ISL28107, Notes 6, 7)	44	3
8 Ld TDFN (ISL28207, Notes 6, 7)	43	2
14 Ld SOIC (ISL28407, Notes 4, 5)	73	45
Storage Temperature Range	-65°C to +150°C	
Pb-Free Reflow Profile	see link below http://www.intersil.com/pbfree/Pb-FreeReflow.asp	

Operating Conditions

Ambient Operating Temperature Range	-40°C to +125°C
Maximum Operating Junction Temperature	+150°C

CAUTION: Do not operate at or near the maximum ratings listed for extended periods of time. Exposure to such conditions may adversely impact product reliability and result in failures not covered by warranty.

NOTES:

- θ_{JA} is measured with the component mounted on a high effective thermal conductivity test board in free air. See Tech Brief [TB379](#) for details.
- For θ_{JC} , the “case temp” location is taken at the package top center.
- θ_{JA} is measured in free air with the component mounted on a high effective thermal conductivity test board with “direct attach” features. See Tech Brief [TB379](#).
- For θ_{JC} , the “case temp” location is the center of the exposed metal pad on the package underside.

Electrical Specifications $V_S \pm 15V$, $V_{CM} = 0$, $V_O = 0V$, $R_L = \text{Open}$, $T_A = +25^\circ\text{C}$, unless otherwise noted. **Boldface limits apply over the operating temperature range, -40°C to +125°C.**

PARAMETER	DESCRIPTION	CONDITIONS	MIN (Note 8)	TYP	MAX (Note 8)	UNIT
V_{OS}	Offset Voltage Magnitude; SOIC Package	ISL28107, ISL28207	-75	5	75	μV
			-140		140	μV
		ISL28407	-90	10	90	μV
			-160		160	μV
	Offset Voltage Magnitude; MSOP Package	ISL28107	-100	5	100	μV
			-180		180	μV
		ISL28207	-110	5	110	μV
			-200		200	μV
	Offset Voltage Magnitude; TDFN Package	ISL28107	-100	10	100	μV
-190				190	μV	
ISL28207		-100	10	100	μV	
		-175		175	μV	
TCV_{OS}	Offset Voltage Drift; SOIC Package	ISL28107, ISL28207	-0.65	0.1	0.65	$\mu\text{V}/^\circ\text{C}$
		ISL28407	-0.8	0.2	0.8	$\mu\text{V}/^\circ\text{C}$
	Offset Voltage Drift; MSOP Package	ISL28107	-0.85	0.1	0.85	$\mu\text{V}/^\circ\text{C}$
		ISL28207	-0.9	0.1	0.9	$\mu\text{V}/^\circ\text{C}$
	Offset Voltage Drift; TDFN Package	ISL28107	-0.9	0.1	0.9	$\mu\text{V}/^\circ\text{C}$
		ISL28207	-0.75	0.1	0.75	$\mu\text{V}/^\circ\text{C}$

ISL28107, ISL28207, ISL28407

Electrical Specifications $V_S \pm 1.5V$, $V_{CM} = 0$, $V_O = 0V$, $R_L = \text{Open}$, $T_A = +25^\circ\text{C}$, unless otherwise noted. **Boldface limits apply over the operating temperature range, -40°C to $+125^\circ\text{C}$.** (Continued)

PARAMETER	DESCRIPTION	CONDITIONS	MIN (Note 8)	TYP	MAX (Note 8)	UNIT
I_B	Input Bias Current ISL28107, ISL28207	$T_A = -40^\circ\text{C}$ to $+85^\circ\text{C}$	-300	15	300	pA
		$T_A = -40^\circ\text{C}$ to $+125^\circ\text{C}$	-600		600	pA
	Input Bias Current ISL28407	$T_A = 0^\circ\text{C}$ to $+70^\circ\text{C}$	-250	50	250	pA
		$T_A = -40^\circ\text{C}$ to $+85^\circ\text{C}$	-330	50	330	pA
		$T_A = -40^\circ\text{C}$ to $+125^\circ\text{C}$	-700		700	pA
TCI_B	Input Bias Current Drift ISL28107, ISL28207	$T_A = -40^\circ\text{C}$ to $+85^\circ\text{C}$	-0.9	0.19	0.9	pA/ $^\circ\text{C}$
		$T_A = -40^\circ\text{C}$ to $+85^\circ\text{C}$; ISL28207 MSOP Package Only	-1.5	0.19	1.5	pA/ $^\circ\text{C}$
		$T_A = -40^\circ\text{C}$ to $+125^\circ\text{C}$	-3.5	0.26	3.5	pA/ $^\circ\text{C}$
	Input Bias Current Drift ISL28407	$T_A = 0^\circ\text{C}$ to $+70^\circ\text{C}$	-1.5	0.3	1.5	pA/ $^\circ\text{C}$
		$T_A = -40^\circ\text{C}$ to $+85^\circ\text{C}$	-2.0	0.3	2.0	pA/ $^\circ\text{C}$
		$T_A = -40^\circ\text{C}$ to $+125^\circ\text{C}$	-3.5	0.3	3.5	pA/ $^\circ\text{C}$
I_{OS}	Input Offset Current ISL28107, ISL28207	$T_A = -40^\circ\text{C}$ to $+85^\circ\text{C}$	-300	15	300	pA
		$T_A = -40^\circ\text{C}$ to $+125^\circ\text{C}$	-600		600	pA
	Input Offset Current ISL28407	$T_A = 0^\circ\text{C}$ to $+70^\circ\text{C}$	-250	50	250	pA
		$T_A = -40^\circ\text{C}$ to $+85^\circ\text{C}$	-330	50	330	pA
		$T_A = -40^\circ\text{C}$ to $+125^\circ\text{C}$	-700		700	pA
TCI_{OS}	Input Offset Current Drift ISL28107, ISL28207	$T_A = -40^\circ\text{C}$ to $+85^\circ\text{C}$	-0.9	0.19	0.9	pA/ $^\circ\text{C}$
		$T_A = -40^\circ\text{C}$ to $+125^\circ\text{C}$	-3.5	0.26	3.5	pA/ $^\circ\text{C}$
		$T_A = -40^\circ\text{C}$ to $+85^\circ\text{C}$; ISL28207 MSOP Package Only	-1.5		1.5	pA/ $^\circ\text{C}$
	Input Offset Current Drift ISL28407	$T_A = 0^\circ\text{C}$ to $+70^\circ\text{C}$	-1.5	0.3	1.5	pA/ $^\circ\text{C}$
		$T_A = -40^\circ\text{C}$ to $+85^\circ\text{C}$	-2.0	0.3	2.0	pA/ $^\circ\text{C}$
		$T_A = -40^\circ\text{C}$ to $+125^\circ\text{C}$	-3.5	0.3	3.5	pA/ $^\circ\text{C}$
V_{CM}	Input Voltage Range	Guaranteed by CMRR test	-13		13	V
CMRR	Common-Mode Rejection Ratio	$V_{CM} = -13V$ to $+13V$	115	145		dB
PSRR	Power Supply Rejection Ratio	$V_S = \pm 2.25V$ to $\pm 20V$	115	145		dB
A_{VOL}	Open-Loop Gain	$V_O = -13V$ to $+13V$, $R_L = 10k\Omega$ to ground	130	152		dB
V_{OH}	Output Voltage High	$R_L = 10k\Omega$ to ground	13.5	13.7		V
		-40°C to $+125^\circ\text{C}$	13.2			V
		$R_L = 2k\Omega$ to ground	13.3	13.55		V
		-40°C to $+125^\circ\text{C}$	13.1			V
V_{OL}	Output Voltage Low	$R_L = 10k\Omega$ to ground		-13.7	-13.5	V
		-40°C to $+125^\circ\text{C}$			-13.2	V
		$R_L = 2k\Omega$ to ground		-13.55	-13.3	V
		-40°C to $+125^\circ\text{C}$			-13.1	V
I_S	Supply Current/Amplifier	$R_L = \text{Open}$		0.21	0.29	mA
					0.35	mA
I_{SC}	Output Short-Circuit Current	(Note 9)		± 40		mA
V_{SUPPLY}	Supply Voltage Range	Guaranteed by PSRR	± 2.25		± 20	V

ISL28107, ISL28207, ISL28407

Electrical Specifications $V_S \pm 15V$, $V_{CM} = 0$, $V_O = 0V$, $R_L = \text{Open}$, $T_A = +25^\circ\text{C}$, unless otherwise noted. **Boldface limits apply over the operating temperature range, -40°C to $+125^\circ\text{C}$.** (Continued)

PARAMETER	DESCRIPTION	CONDITIONS	MIN (Note 8)	TYP	MAX (Note 8)	UNIT
AC SPECIFICATIONS						
GBW	Gain Bandwidth Product			1		MHz
$e_{n\text{p-p}}$	Voltage Noise	0.1Hz to 10Hz, $V_S = \pm 19V$		340		nV _{P-P}
e_n	Voltage Noise Density	$f = 10\text{Hz}$, $V_S = \pm 19V$		14		nV/ $\sqrt{\text{Hz}}$
e_n	Voltage Noise Density	$f = 100\text{Hz}$, $V_S = \pm 19V$		13		nV/ $\sqrt{\text{Hz}}$
e_n	Voltage Noise Density	$f = 1\text{kHz}$, $V_S = \pm 19V$		13		nV/ $\sqrt{\text{Hz}}$
e_n	Voltage Noise Density	$f = 10\text{kHz}$, $V_S = \pm 19V$		13		nV/ $\sqrt{\text{Hz}}$
i_n	Current Noise Density	$f = 10\text{kHz}$, $V_S = \pm 19V$		53		fA/ $\sqrt{\text{Hz}}$
THD + N	Total Harmonic Distortion + Noise	1kHz, $G = 1$, $V_O = 3.5V_{\text{RMS}}$, $R_L = 2k\Omega$		0.0035		%
TRANSIENT RESPONSE						
SR	Slew Rate	$A_V = 10$, $R_L = 10k\Omega$, $V_O = 10V_{\text{P-P}}$		± 0.32		V/ μs
t_r , t_f , Small Signal	Rise Time 10% to 90% of V_{OUT}	$A_V = 1$, $V_{\text{OUT}} = 100\text{mV}_{\text{P-P}}$, $R_f = 0\Omega$, $R_L = 2k\Omega$ to V_{CM}		355		ns
	Fall Time 90% to 10% of V_{OUT}	$A_V = 1$, $V_{\text{OUT}} = 100\text{mV}_{\text{P-P}}$, $R_f = 0\Omega$, $R_L = 2k\Omega$ to V_{CM}		365		ns
t_s	Settling Time to 0.1% 10V Step; 10% to V_{OUT}	$A_V = -1$, $V_{\text{OUT}} = 10V_{\text{P-P}}$, $R_g = R_f = 10k$, $R_L = 2k\Omega$ to V_{CM}		29		μs
	Settling Time to 0.01% 10V Step; 10% to V_{OUT}	$A_V = -1$, $V_{\text{OUT}} = 10V_{\text{P-P}}$, $R_g = R_f = 10k$, $R_L = 2k\Omega$ to V_{CM}		31.2		μs
t_{OL}	Output Overload Recovery Time	$A_V = 100$, $V_{\text{IN}} = 0.2V$, $R_L = 2k\Omega$ to V_{CM}		6		μs

Electrical Specifications $V_S \pm 5V$, $V_{CM} = 0$, $V_O = 0V$, $T_A = +25^\circ\text{C}$, unless otherwise noted. **Boldface limits apply over the operating temperature range, -40°C to $+125^\circ\text{C}$.**

PARAMETER	DESCRIPTION	CONDITIONS	MIN (Note 8)	TYP	MAX (Note 8)	UNIT
V_{OS}	Offset Voltage Magnitude; SOIC Package	ISL28107, ISL28207	-75	5	75	μV
			-140		140	μV
		ISL28407	-90	10	90	μV
			-160		160	μV
	Offset Voltage Magnitude; MSOP Package	ISL28107	-100	5	100	μV
			-180		180	μV
		ISL28207	-110	5	110	μV
			-200		200	μV
Offset Voltage Magnitude; TDFN Package	ISL28107	-100	10	100	μV	
		-190		190	μV	
	ISL28207	-100	10	100	μV	
		-175		175	μV	

ISL28107, ISL28207, ISL28407

Electrical Specifications $V_S \pm 5V$, $V_{CM} = 0$, $V_O = 0V$, $T_A = +25^\circ C$, unless otherwise noted. **Boldface limits apply over the operating temperature range, $-40^\circ C$ to $+125^\circ C$.** (Continued)

PARAMETER	DESCRIPTION	CONDITIONS	MIN (Note 8)	TYP	MAX (Note 8)	UNIT
TCV _{OS}	Offset Voltage Drift; SOIC Package	ISL28107, ISL28207	-0.65	0.1	0.65	$\mu V/^\circ C$
		ISL28407	-0.8	0.2	0.8	$\mu V/^\circ C$
	Offset Voltage Drift; MSOP Package	ISL28107	-0.85	0.1	0.85	$\mu V/^\circ C$
		ISL28207	-0.9	0.1	0.9	$\mu V/^\circ C$
	Offset Voltage Drift; TDFN Package	ISL28107	-0.9	0.1	0.9	$\mu V/^\circ C$
		ISL28207	-0.75	0.1	0.75	$\mu V/^\circ C$
I _B	Input Bias Current ISL28107, ISL28207	$T_A = -40^\circ C$ to $+85^\circ C$	-300	15	300	pA
		$T_A = -40^\circ C$ to $+125^\circ C$	-600		600	pA
	Input Bias Current ISL28407	$T_A = 0^\circ C$ to $+70^\circ C$	-250	50	250	pA
		$T_A = -40^\circ C$ to $+85^\circ C$	-330	50	330	pA
		$T_A = -40^\circ C$ to $+125^\circ C$	-700		700	pA
	TCI _B	Input Bias Current Drift ISL28107, ISL28207	$T_A = -40^\circ C$ to $+85^\circ C$	-0.9	0.19	0.9
$T_A = -40^\circ C$ to $+85^\circ C$; ISL28207 MSOP Package Only			-1.5	0.19	1.5	$pA/^\circ C$
$T_A = -40^\circ C$ to $+125^\circ C$			-3.5	0.26	3.5	$pA/^\circ C$
Input Bias Current Drift ISL28407		$T_A = 0^\circ C$ to $+70^\circ C$	-1.5	0.3	1.5	$pA/^\circ C$
		$T_A = -40^\circ C$ to $+85^\circ C$	-2.0	0.3	2.0	$pA/^\circ C$
		$T_A = -40^\circ C$ to $+125^\circ C$	-3.5	0.3	3.5	$pA/^\circ C$
I _{OS}	Input Offset Current ISL28107, ISL28207	$T_A = -40^\circ C$ to $+85^\circ C$	-300	15	300	pA
		$T_A = -40^\circ C$ to $+125^\circ C$	-600		600	pA
	Input Offset Current ISL28407	$T_A = 0^\circ C$ to $+70^\circ C$	-250	50	250	pA
		$T_A = -40^\circ C$ to $+85^\circ C$	-330	50	330	pA
		$T_A = -40^\circ C$ to $+125^\circ C$	-700		700	pA
	TCI _{OS}	Input Offset Current Drift ISL28107, ISL28207	$T_A = -40^\circ C$ to $+85^\circ C$	-0.9	0.19	0.9
$T_A = -40^\circ C$ to $+125^\circ C$			-3.5	0.26	3.5	$pA/^\circ C$
$T_A = -40^\circ C$ to $+85^\circ C$; ISL28207 MSOP Package Only			-1.5		1.5	$pA/^\circ C$
Input Offset Current Drift ISL28407		$T_A = 0^\circ C$ to $+70^\circ C$	-1.5	0.3	1.5	$pA/^\circ C$
		$T_A = -40^\circ C$ to $+85^\circ C$	-2.0	0.3	2.0	$pA/^\circ C$
		$T_A = -40^\circ C$ to $+125^\circ C$	-3.5	0.3	3.5	$pA/^\circ C$
V _{CM}	Common Mode Input Voltage Range	Guaranteed by CMRR test	-3		3	V
CMRR	Common-Mode Rejection Ratio	V _{CM} = -3V to +3V	115	145		dB
PSRR	Power Supply Rejection Ratio	V _S = $\pm 2.25V$ to $\pm 5V$	115	145		dB
A _{VOL}	Open-Loop Gain	V _O = -3V to +3V, R _L = 10k Ω to ground	130	152		dB
V _{OH}	Output Voltage High	R _L = 10k Ω to ground	3.5	3.7		V
		$-40^\circ C$ to $+125^\circ C$	3.2			V
	R _L = 2k Ω to ground		3.3	3.55		V
		$-40^\circ C$ to $+125^\circ C$	3.1			V

ISL28107, ISL28207, ISL28407

Electrical Specifications $V_S \pm 5V$, $V_{CM} = 0$, $V_O = 0V$, $T_A = +25^\circ C$, unless otherwise noted. **Boldface limits apply over the operating temperature range, $-40^\circ C$ to $+125^\circ C$.** (Continued)

PARAMETER	DESCRIPTION	CONDITIONS	MIN (Note 8)	TYP	MAX (Note 8)	UNIT
V_{OL}	Output Voltage Low	$R_L = 10k\Omega$ to ground $-40^\circ C$ to $+125^\circ C$		-3.7	-3.5	V
					-3.2	V
		$R_L = 2k\Omega$ to ground $-40^\circ C$ to $+125^\circ C$		-3.55	-3.3	V
					-3.1	V
I_S	Supply Current/Amplifier	$R_L = \text{Open}$		0.21	0.29	mA
					0.35	mA
I_{SC}	Output Short-Circuit Current	(Note 9)		± 40		mA
AC SPECIFICATIONS						
GBW	Gain Bandwidth Product			1		MHz
THD + N	Total Harmonic Distortion + Noise	1kHz, $G = 1$, $V_O = 2.5V_{RMS}$, $R_L = 2k\Omega$		0.0053		%
TRANSIENT RESPONSE						
SR	Slew Rate	$A_V = 10$, $R_L = 2k\Omega$		0.32		V/ μs
t_r , t_f , Small Signal	Rise Time 10% to 90% of V_{OUT}	$A_V = 1$, $V_{OUT} = 100mV_{P-P}$, $R_f = 0\Omega$, $R_L = 2k\Omega$ to V_{CM}		355		ns
	Fall Time 90% to 10% of V_{OUT}	$A_V = 1$, $V_{OUT} = 100mV_{P-P}$, $R_f = 0\Omega$, $R_L = 2k\Omega$ to V_{CM}		370		ns
t_s	Settling Time to 0.1% 4V Step; 10% to V_{OUT}	$A_V = -1$, $V_{OUT} = 4V_{P-P}$, $R_f = R_g = 2k\Omega$, $R_L = 2k\Omega$ to V_{CM}		12.4		μs
	Settling Time to 0.01% 4V Step; 10% to V_{OUT}	$A_V = -1$, $V_{OUT} = 4V_{P-P}$, $R_f = R_g = 2k\Omega$, $R_L = 2k\Omega$ to V_{CM}		22		μs

NOTES:

- Parameters with MIN and/or MAX limits are 100% tested at $+25^\circ C$, unless otherwise specified. Temperature limits established by characterization and are not production tested.
- Output Short Circuit Current is the minimum current (source or sink) when the output is driven into the supply rails with $R_L = 0\Omega$ to ground.

Typical Performance Curves

$V_S = \pm 15V$, $V_{CM} = 0V$, $R_L = \text{Open}$, $T_A = +25^\circ\text{C}$ unless otherwise specified.

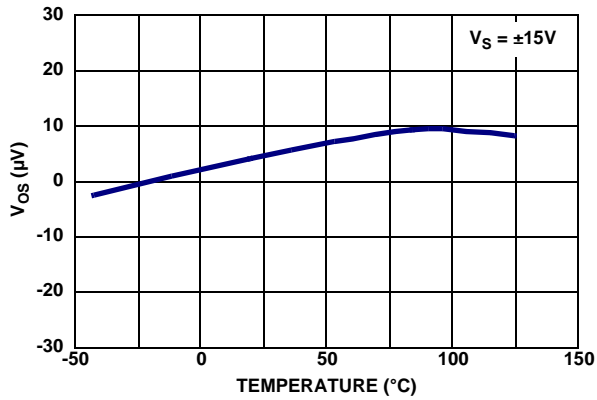

FIGURE 3. INPUT OFFSET VOLTAGE vs TEMPERATURE, $V_S = \pm 15V$

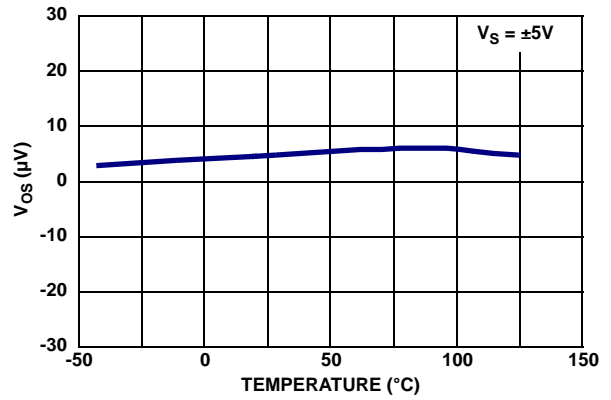

FIGURE 4. INPUT OFFSET VOLTAGE vs TEMPERATURE, $V_S = \pm 5V$

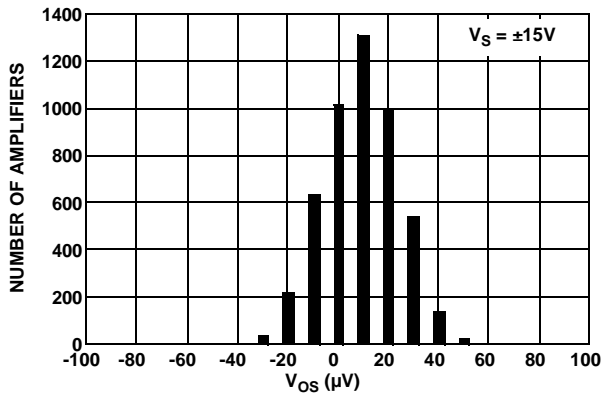

FIGURE 5. INPUT OFFSET VOLTAGE DISTRIBUTION, $V_S = \pm 15V$

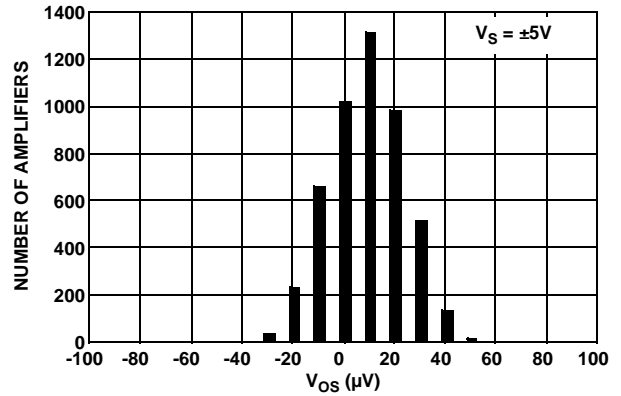

FIGURE 6. INPUT OFFSET VOLTAGE DISTRIBUTION, $V_S = \pm 5V$

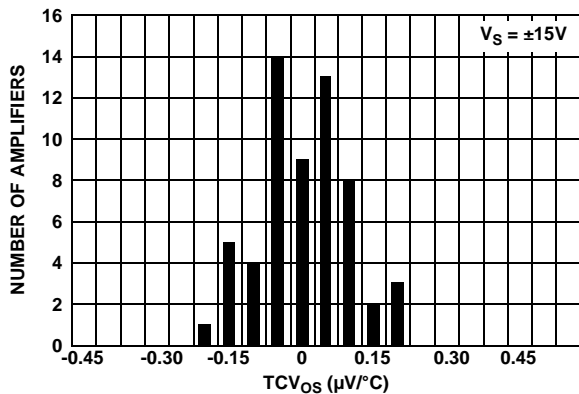

FIGURE 7. TCV_{OS} vs NUMBER OF AMPLIFIERS, $V_S = \pm 15V$

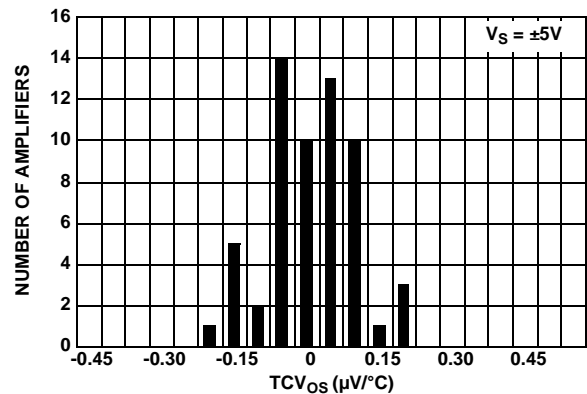

FIGURE 8. TCV_{OS} vs NUMBER OF AMPLIFIERS, $V_S = \pm 5V$

Typical Performance Curves $V_S = \pm 15V, V_{CM} = 0V, R_L = \text{Open}, T_A = +25^\circ\text{C}$ unless otherwise specified. (Continued)

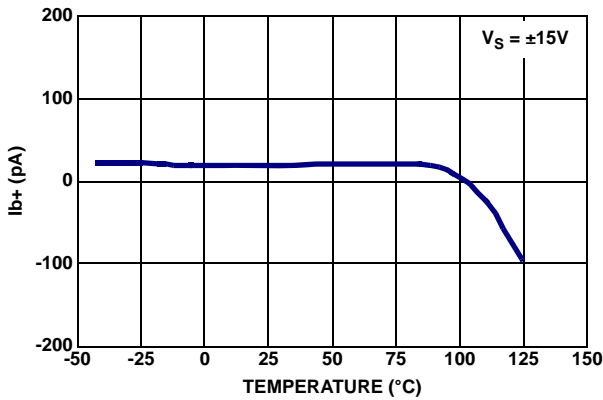

FIGURE 9. POSITIVE BIAS CURRENT vs TEMPERATURE, $V_S = \pm 15V$

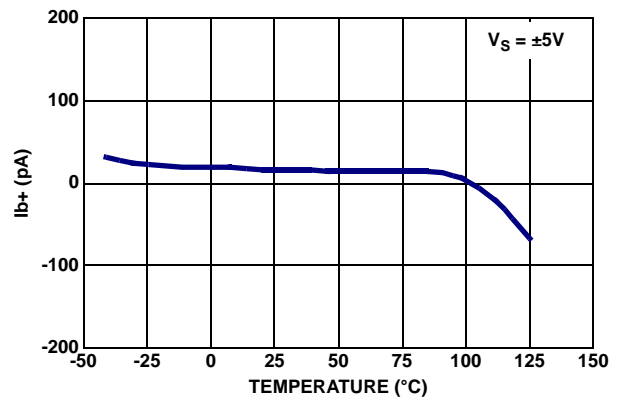

FIGURE 10. POSITIVE BIAS CURRENT vs TEMPERATURE, $V_S = \pm 5V$

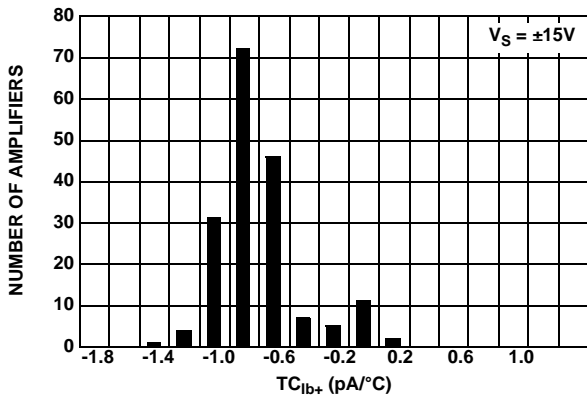

FIGURE 11. TC_{Ib+} vs NUMBER OF AMPLIFIERS, $V_S = \pm 15V$

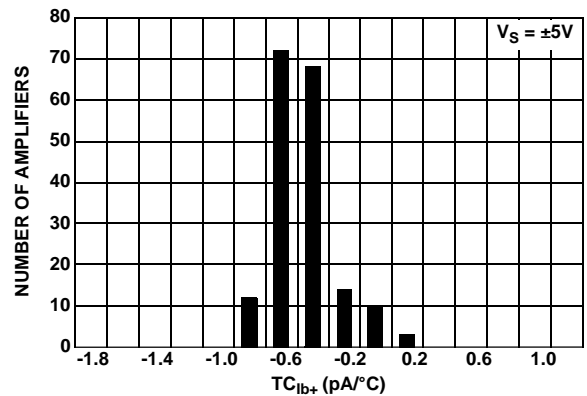

FIGURE 12. TC_{Ib+} vs NUMBER OF AMPLIFIERS, $V_S = \pm 5V$

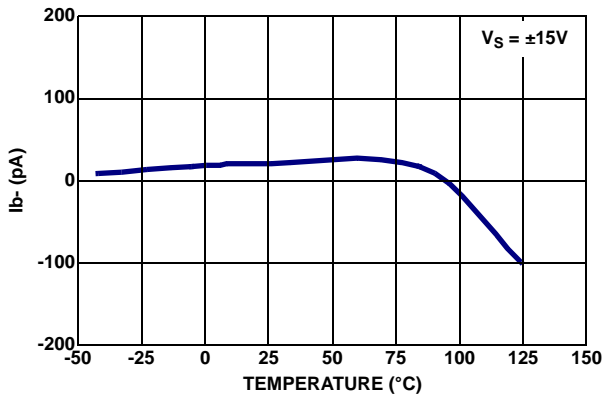

FIGURE 13. NEGATIVE BIAS CURRENT vs TEMPERATURE, $V_S = \pm 15V$

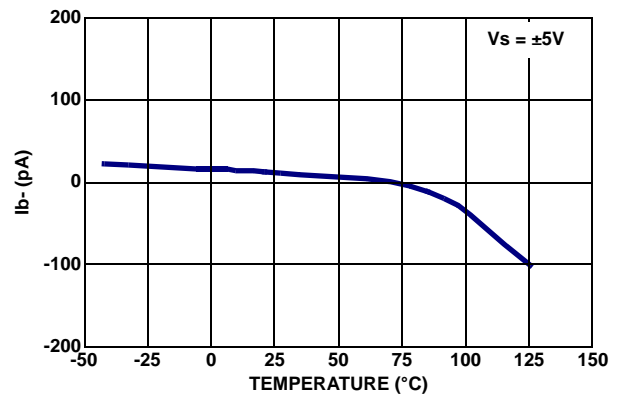

FIGURE 14. NEGATIVE BIAS CURRENT vs TEMPERATURE, $V_S = \pm 5V$

Typical Performance Curves $V_S = \pm 15V, V_{CM} = 0V, R_L = \text{Open}, T_A = +25^\circ C$ unless otherwise specified. (Continued)

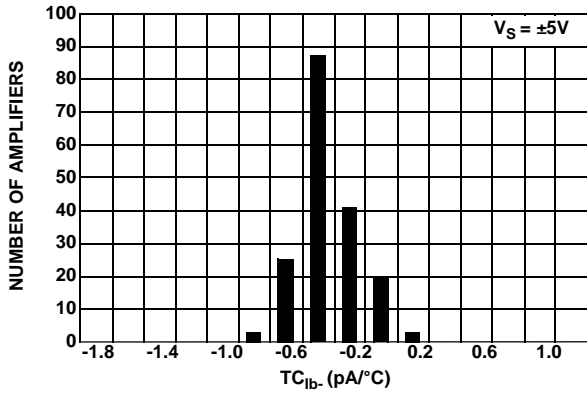

FIGURE 15. TC_{1b} vs NUMBER OF AMPLIFIERS, V_S = ±5V

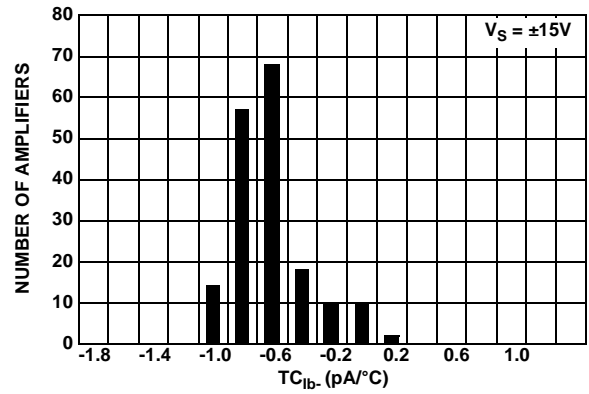

FIGURE 16. TC_{1b} vs NUMBER OF AMPLIFIERS, V_S = ±15V

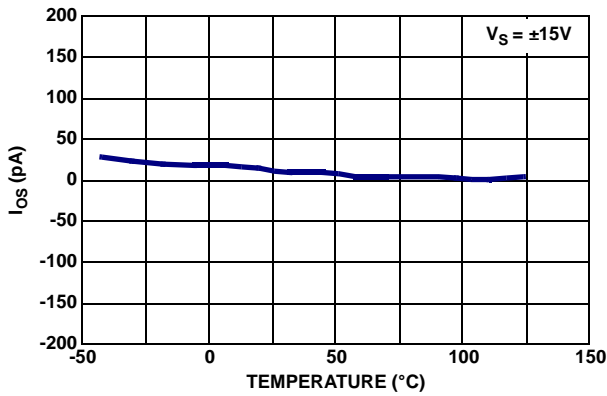

FIGURE 17. OFFSET CURRENT vs TEMPERATURE, V_S = ±15V

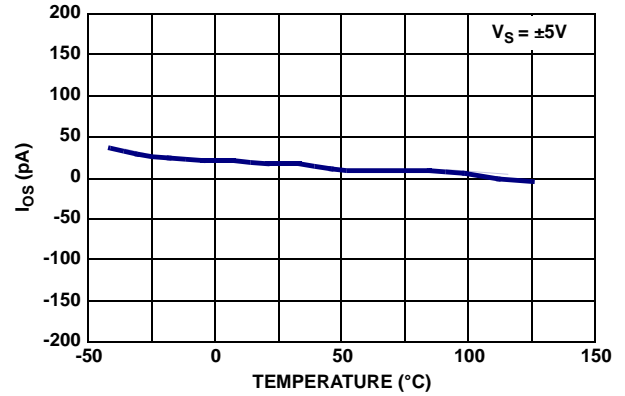

FIGURE 18. OFFSET CURRENT vs TEMPERATURE, V_S = ±5V

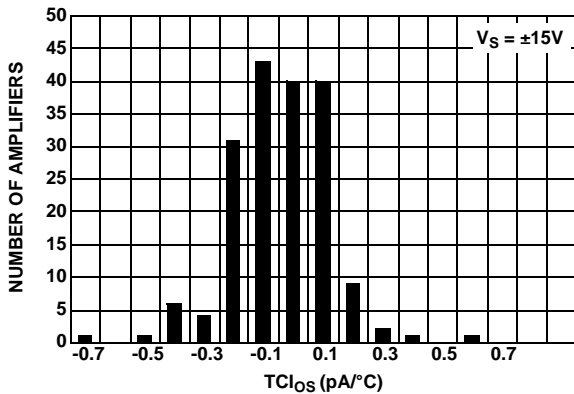

FIGURE 19. TC_{1os-} vs NUMBER OF AMPLIFIERS, V_S = ±15V

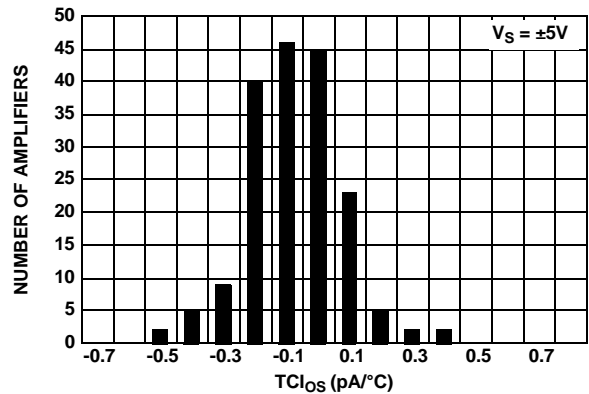

FIGURE 20. TC_{1os-} vs NUMBER OF AMPLIFIERS, V_S = ±5V

Typical Performance Curves $V_S = \pm 15V, V_{CM} = 0V, R_L = \text{Open}, T_A = +25^\circ C$ unless otherwise specified. (Continued)

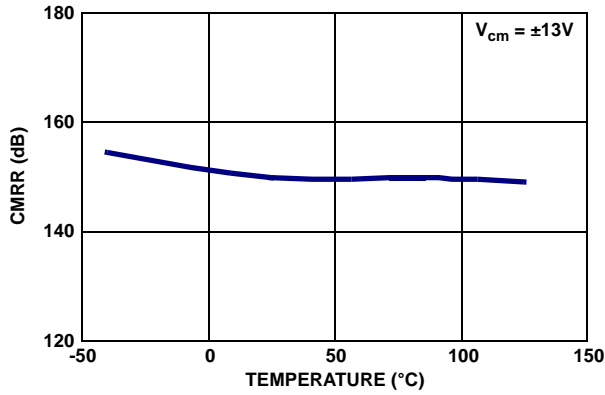

FIGURE 21. CMRR vs TEMPERATURE

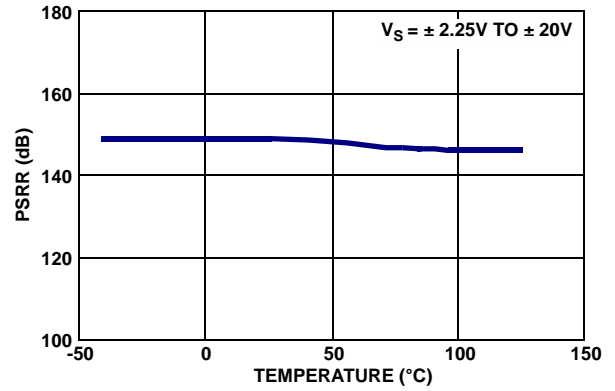

FIGURE 22. PSRR vs TEMPERATURE

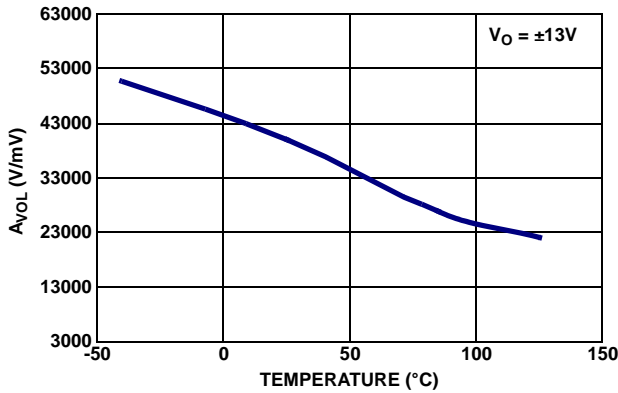

FIGURE 23. AVOL vs TEMPERATURE

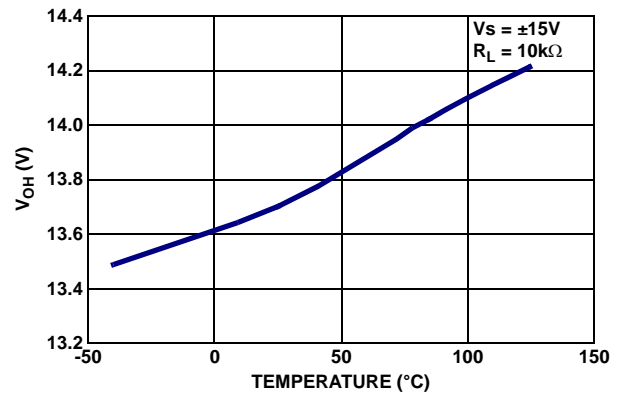

FIGURE 24. VOH vs TEMPERATURE, VS = ±15V, RL = 10kΩ

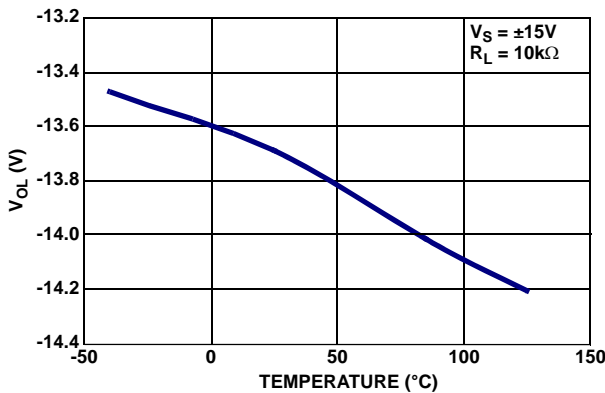

FIGURE 25. VOL vs TEMPERATURE, VS = ±15V, RL = 10kΩ

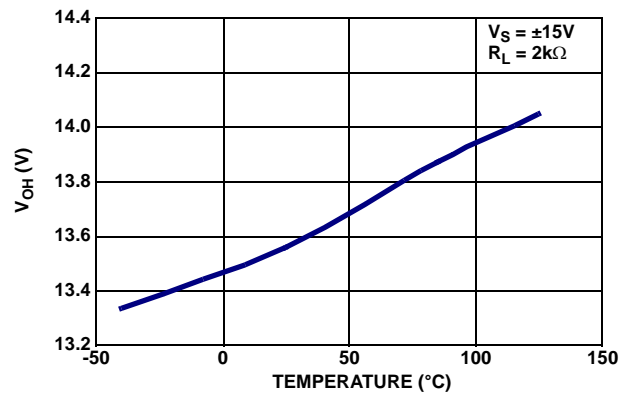

FIGURE 26. VOH vs TEMPERATURE, VS = ±15V, RL = 2kΩ

Typical Performance Curves $V_S = \pm 15V, V_{CM} = 0V, R_L = \text{Open}, T_A = +25^\circ C$ unless otherwise specified. (Continued)

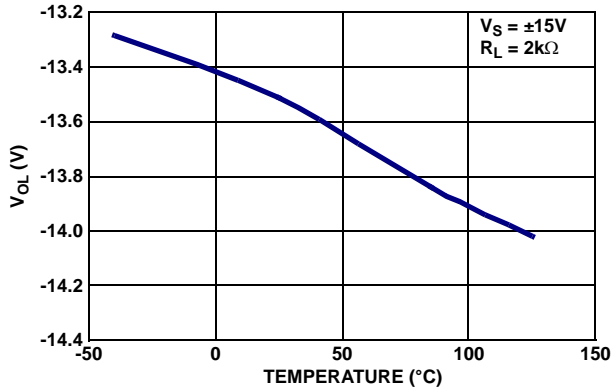

FIGURE 27. V_{OL} vs TEMPERATURE, $V_S = \pm 15V, R_L = 2k\Omega$

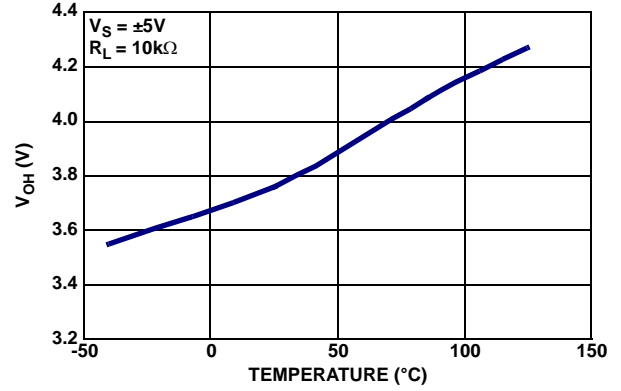

FIGURE 28. V_{OH} vs TEMPERATURE, $V_S = \pm 5V, R_L = 10k\Omega$

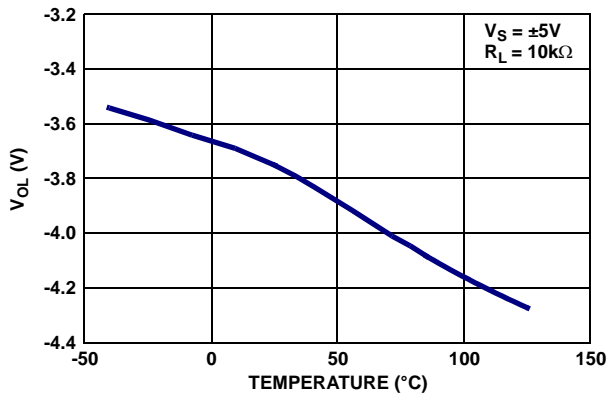

FIGURE 29. V_{OL} vs TEMPERATURE, $V_S = \pm 5V, R_L = 10k\Omega$

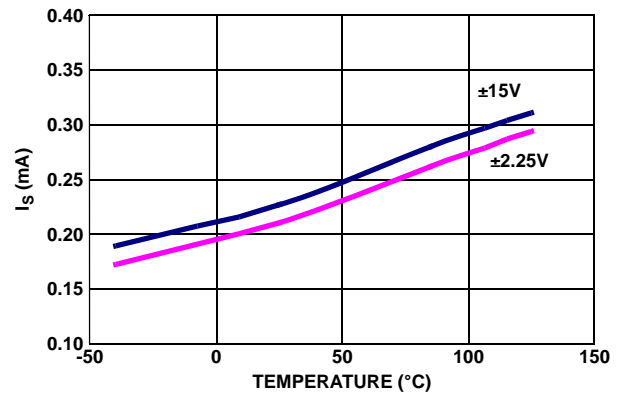

FIGURE 30. SUPPLY CURRENT vs TEMPERATURE

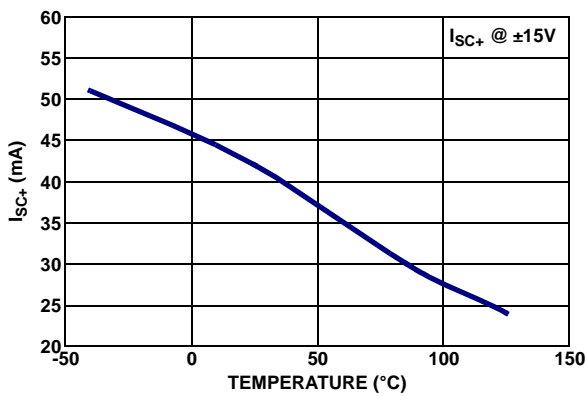

FIGURE 31. POSITIVE SHORT CIRCUIT CURRENT vs TEMPERATURE

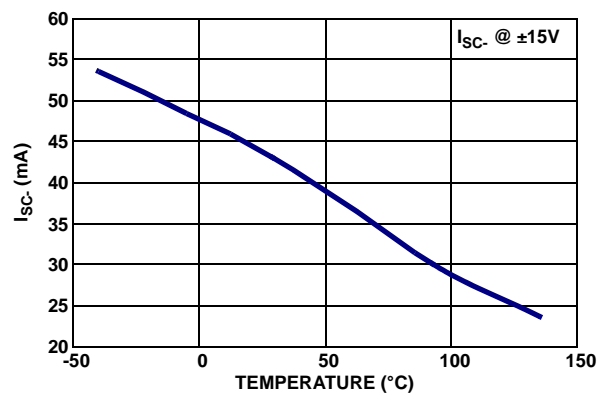

FIGURE 32. NEGATIVE SHORT CIRCUIT CURRENT vs TEMPERATURE

Typical Performance Curves $V_S = \pm 15V, V_{CM} = 0V, R_L = \text{Open}, T_A = +25^\circ C$ unless otherwise specified. (Continued)

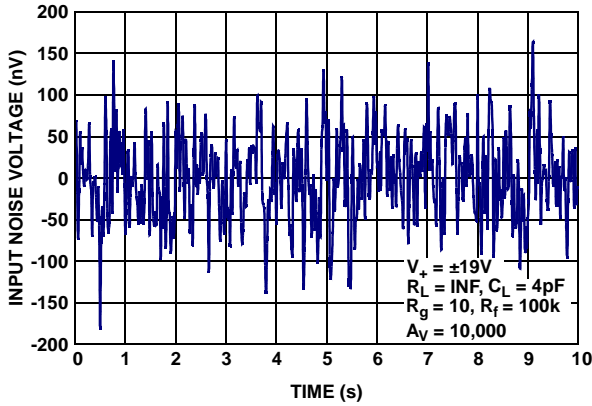

FIGURE 33. INPUT NOISE VOLTAGE 0.1Hz TO 10Hz

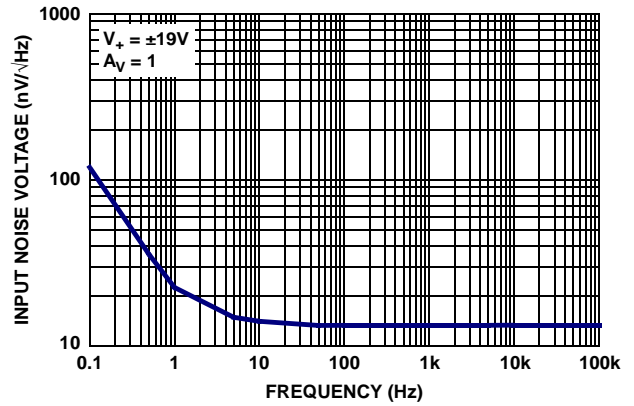

FIGURE 34. INPUT NOISE VOLTAGE SPECTRAL DENSITY

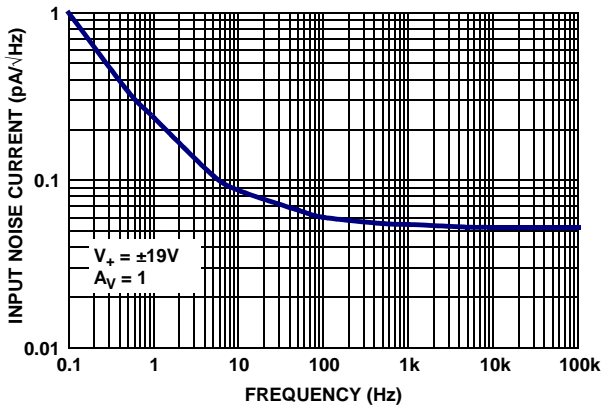

FIGURE 35. INPUT NOISE CURRENT SPECTRAL DENSITY

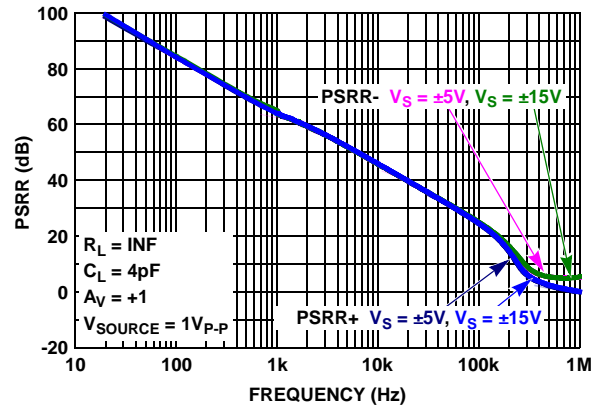

FIGURE 36. PSRR vs FREQUENCY, $V_S = \pm 5V, \pm 15V$

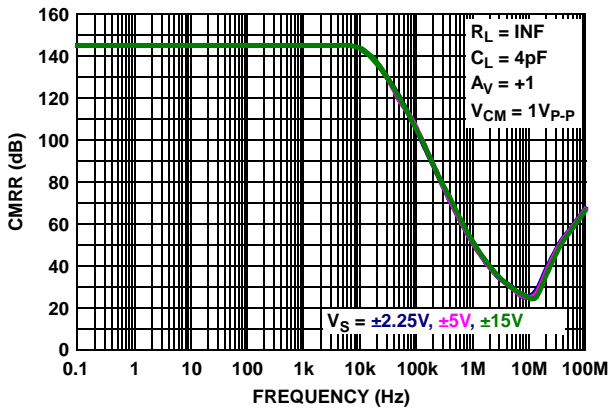

FIGURE 37. CMRR vs FREQUENCY, $V_S = \pm 2.25V, \pm 5V, \pm 15V$

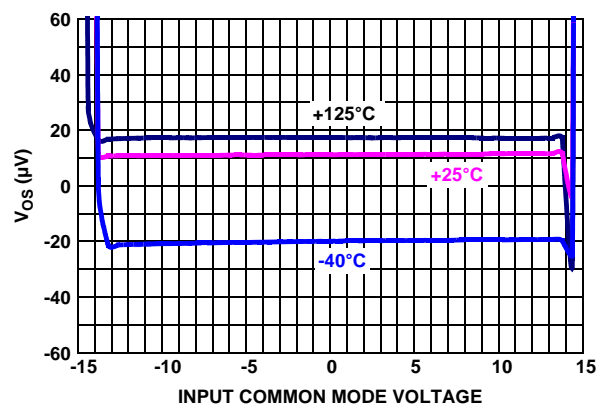

FIGURE 38. INPUT OFFSET VOLTAGE vs INPUT COMMON MODE VOLTAGE, $V_S = \pm 15V$

Typical Performance Curves $V_S = \pm 15V, V_{CM} = 0V, R_L = \text{Open}, T_A = +25^\circ C$ unless otherwise specified. (Continued)

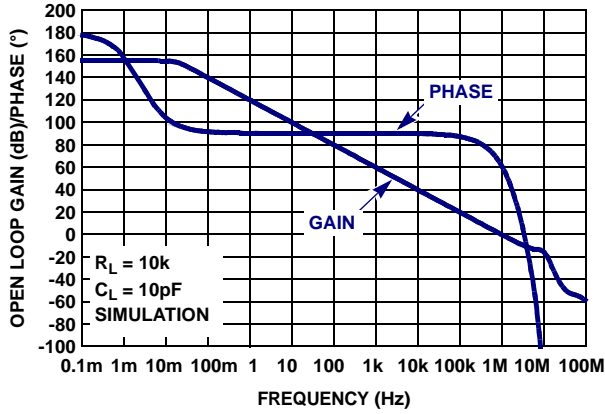

FIGURE 39. OPEN-LOOP GAIN, PHASE vs FREQUENCY, $R_L = 10k\Omega, C_L = 10pF$

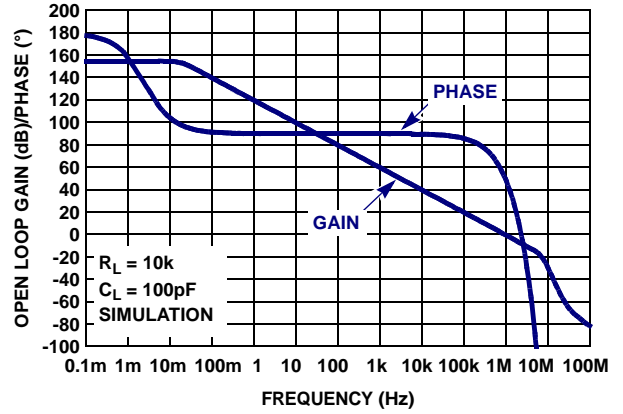

FIGURE 40. OPEN-LOOP GAIN, PHASE vs FREQUENCY, $R_L = 10k\Omega, C_L = 100pF$

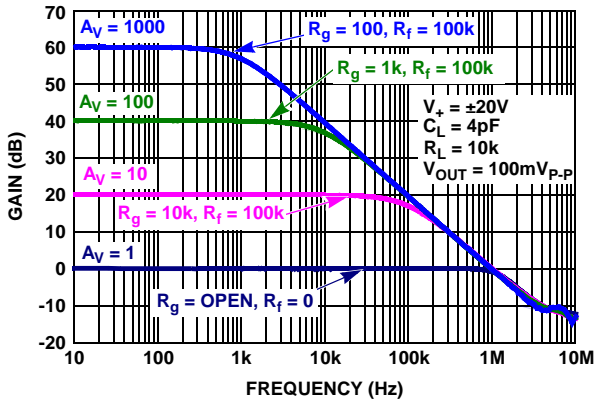

FIGURE 41. FREQUENCY RESPONSE vs CLOSED LOOP GAIN

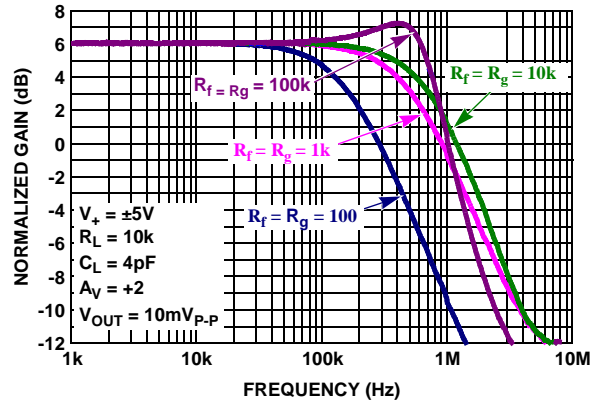

FIGURE 42. FREQUENCY RESPONSE vs FEEDBACK RESISTANCE R_f/R_g

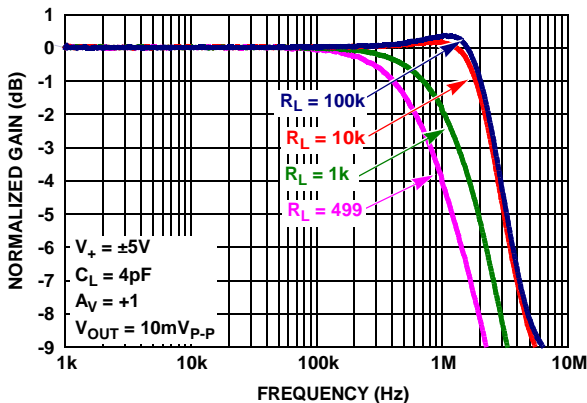

FIGURE 43. GAIN vs FREQUENCY vs R_L

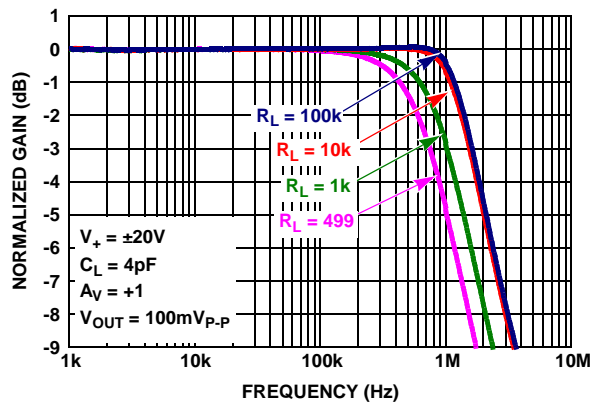

FIGURE 44. GAIN vs FREQUENCY vs R_L

Typical Performance Curves $V_S = \pm 15V, V_{CM} = 0V, R_L = \text{Open}, T_A = +25^\circ C$ unless otherwise specified. (Continued)

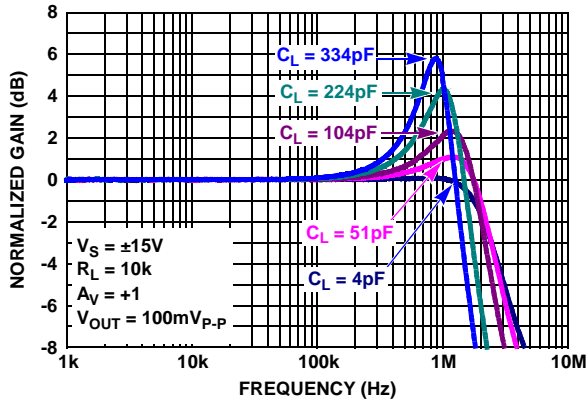

FIGURE 45. GAIN vs FREQUENCY vs C_L

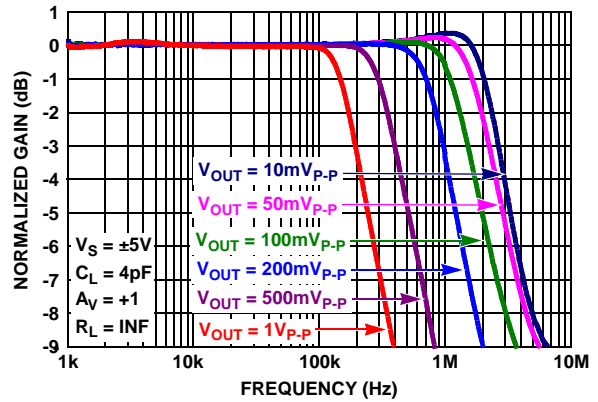

FIGURE 46. GAIN vs FREQUENCY vs OUTPUT VOLTAGE

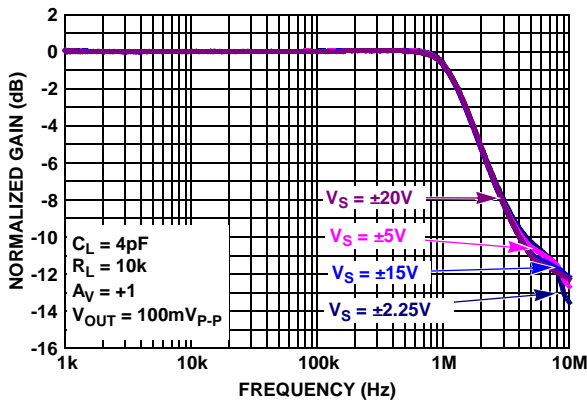

FIGURE 47. GAIN vs FREQUENCY vs SUPPLY VOLTAGE

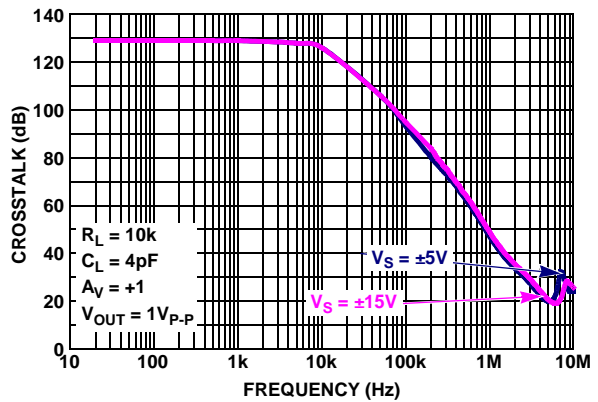

FIGURE 48. CROSSTALK vs FREQUENCY, $V_S = \pm 5V, \pm 15V$

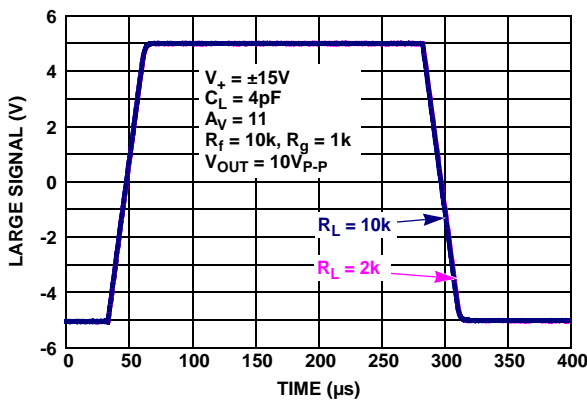

FIGURE 49. LARGE SIGNAL 10V STEP RESPONSE, $V_S = \pm 15V$

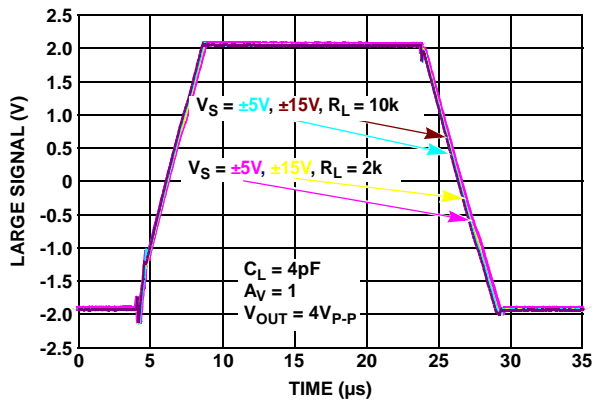

FIGURE 50. LARGE SIGNAL TRANSIENT RESPONSE vs $R_L, V_S = \pm 5V, \pm 15V$

Typical Performance Curves $V_S = \pm 15V, V_{CM} = 0V, R_L = \text{Open}, T_A = +25^\circ\text{C}$ unless otherwise specified. (Continued)

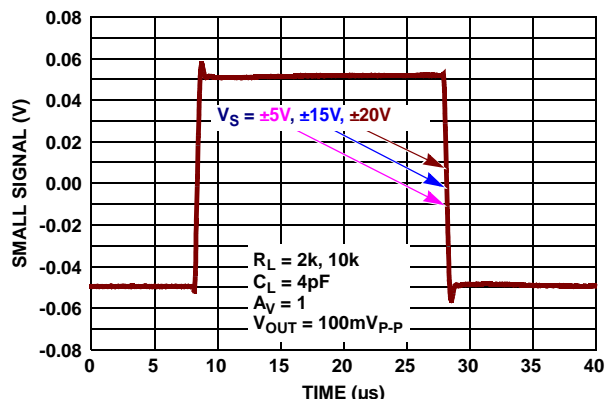

FIGURE 51. SMALL SIGNAL TRANSIENT RESPONSE $V_S = \pm 5V, \pm 15V, \pm 20V$

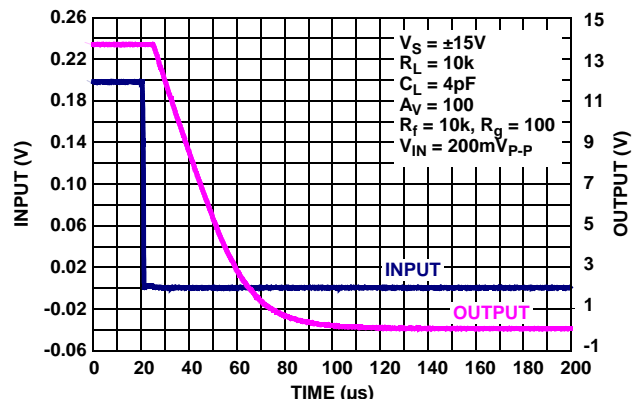

FIGURE 52. POSITIVE OUTPUT OVERLOAD RESPONSE TIME, $V_S = \pm 15V$

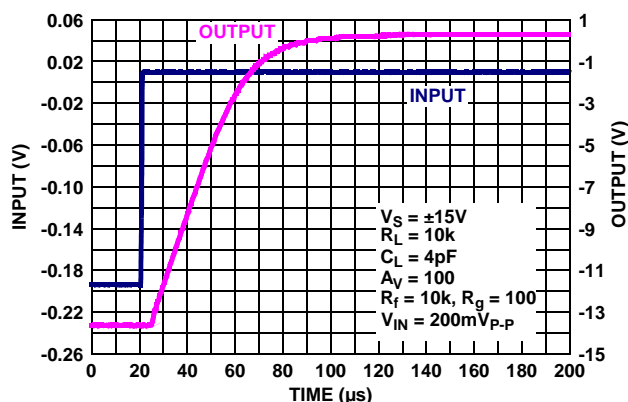

FIGURE 53. NEGATIVE OUTPUT OVERLOAD RESPONSE TIME, $V_S = \pm 15V$

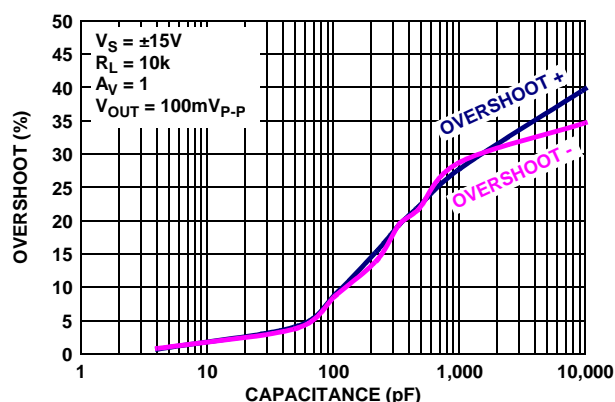

FIGURE 54. % OVERSHOOT vs LOAD CAPACITANCE, $V_S = \pm 15V$

Applications Information

Functional Description

The ISL28107, ISL28207 and ISL28407 are single, dual and quad, very low $1/f$ noise ($14\text{nV}/\sqrt{\text{Hz}}$ @ 10Hz) precision op-amps. These amplifiers feature very high open loop gain ($50\text{kV}/\text{mV}$) for excellent CMRR (145dB) and gain accuracy. Both devices are fabricated in a new precision 40V complementary bipolar DI process.

The super-beta NPN input stage with bias current cancellation provides bipolar-like levels of AC performance, with the low input bias currents approaching JFET levels. The temperature stabilization provided by bias current cancellation removes the high input bias current temperature coefficient commonly found in JFET amplifiers. Figures 9 and 10 show the input bias current variation over temperature.

The input offset voltage (V_{OS}) has a very low, worst case value of $75\mu\text{V}$ max at $+25^\circ\text{C}$ and a maximum T_C of $0.65\mu\text{V}/^\circ\text{C}$. Figure 38 shows V_{OS} as a function of supply voltage and temperature with the common mode voltage at 0V for split supply operation.

The complementary bipolar output stage maintains stability driving large capacitive loads (to 10nF) without external compensation. The small signal overshoot vs. load capacitance is shown in Figure 54.

Operating Voltage Range

The devices are designed to operate over the 4.5V ($\pm 2.25\text{V}$) to 40V ($\pm 20\text{V}$) range and are fully characterized at 10V ($\pm 5\text{V}$) and 30V ($\pm 15\text{V}$). Both DC and AC performance remain virtually unchanged over the complete 4.5V to 40V operating voltage range. Parameter variation with operating voltage is shown in the “Typical Performance Curves” beginning on page 11. The input common mode voltage range sensitivity to temperature is shown in Figure 38 ($\pm 15\text{V}$).

Input ESD Diode Protection

The input terminals (IN+ and IN-) each have internal ESD protection diodes to the positive and negative supply rails, a series connected 500Ω current limiting resistor followed by an anti-parallel diode pair across the input NPN transistors (Circuit 1 in “Pin Descriptions” on page 4).

ISL28107, ISL28207, ISL28407

The resistor-ESD diode configuration enables a wide differential input voltage range equal to the lesser of the Maximum Supply Voltage in the “Absolute Maximum Ratings” on page 6 (42V), or a maximum of 0.5V beyond the V+ and V- supply voltage. The internal protection resistors eliminate the need for external input current limiting resistors in unity gain connections and other circuit applications where large voltages or high slew rate signals are present. Although the amplifier is fully protected, high input slew rates that exceed the amplifier slew rate ($\pm 0.32\text{V}/\mu\text{s}$) may cause output distortion.

Output Current Limiting

The output current is internally limited to approximately $\pm 40\text{mA}$ at $+25^\circ\text{C}$ and can withstand a short circuit to either rail as long as the power dissipation limits are not exceeded. This applies to only one amplifier at a time for the dual op-amp. Continuous operation under these conditions may degrade long-term reliability.

Output Phase Reversal

Output phase reversal is a change of polarity in the amplifier transfer function when the input voltage exceeds the supply voltage. The ISL28107, ISL28207 and ISL28407 are immune to output phase reversal, even when the input voltage is 1V beyond the supplies.

Unused Channels

If the application only requires one channel, the user must configure the unused channels to prevent them from oscillating. The unused channels can oscillate if the input and output pins are floating. This results in higher than expected supply currents and possible noise injection into the channel being used. The proper way to prevent this oscillation is to short the output to the inverting input and ground the positive input, as shown in Figure 55.

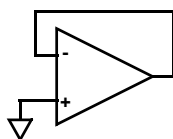

FIGURE 55. PREVENTING OSCILLATIONS IN UNUSED CHANNELS

Power Dissipation

It is possible to exceed the $+150^\circ\text{C}$ maximum junction temperatures under certain load and power supply conditions. It is therefore important to calculate the maximum junction temperature (T_{JMAX}) for all applications to determine if power supply voltages, load conditions, or package type need to be modified to remain in the safe operating area. These parameters are related using Equation 1:

$$T_{JMAX} = T_{MAX} + \theta_{JA} \times PD_{MAXTOTAL} \quad (\text{EQ. 1})$$

where:

- $PD_{MAXTOTAL}$ is the sum of the maximum power dissipation of each amplifier in the package (PD_{MAX})

PD_{MAX} for each amplifier can be calculated using Equation 2:

$$PD_{MAX} = V_S \times I_{qMAX} + (V_S - V_{OUTMAX}) \times \frac{V_{OUTMAX}}{R_L} \quad (\text{EQ. 2})$$

where:

- T_{MAX} = Maximum ambient temperature
- θ_{JA} = Thermal resistance of the package
- PD_{MAX} = Maximum power dissipation of one amplifier
- V_S = Total supply voltage
- I_{qMAX} = Maximum quiescent supply current of one amplifier
- V_{OUTMAX} = Maximum output voltage swing of the application
- R_L = Load resistance

ISL28107, ISL28207, ISL28407 SPICE Model

Figure 56 shows the SPICE model schematic, and Figure 57 shows the net list for the ISL28107, ISL28207 and ISL28407 SPICE model. The model is a simplified version of the actual device and simulates important AC and DC parameters. AC parameters incorporated into the model are: $1/f$ and flatband noise, Slew Rate, CMRR, Gain and Phase. The DC parameters are VOS, IOS, total supply current and output voltage swing. The model uses typical parameters given in the “Electrical Specifications” table beginning on page 6. A_{VOL} is adjusted for 155dB with the dominant pole at 0.01Hz. CMRR is set (145dB, $f_{cm} = 100\text{Hz}$). The input stage models the actual device to present an accurate AC representation. The model is configured for ambient temperature of $+25^\circ\text{C}$.

Figures 58 through 68 show the characterization vs simulation results for the Noise Voltage, Closed Loop Gain vs Frequency, Closed Loop Gain vs R_L , Large Signal Step Response, Open Loop Gain Phase and Simulated CMRR vs Frequency.

License Statement

The information in this SPICE model is protected under the United States copyright laws. Intersil Corporation hereby grants users of this macro-model hereto referred to as “Licensee”, a nonexclusive, nontransferable licence to use this model as long as the Licensee abides by the terms of this agreement. Before using this macro-model, the Licensee should read this license. If the Licensee does not accept these terms, permission to use the model is not granted.

The Licensee may not sell, loan, rent, or license the macro-model, in whole, in part, or in modified form, to anyone outside the Licensee’s company. The Licensee may modify the macro-model to suit his/her specific applications, and the Licensee may make copies of this macro-model for use within their company only.

This macro-model is provided “AS IS, WHERE IS, AND WITH NO WARRANTY OF ANY KIND EITHER EXPRESSED OR IMPLIED, INCLUDING BUY NOT LIMITED TO ANY IMPLIED WARRANTIES OF MERCHANTABILITY AND FITNESS FOR A PARTICULAR PURPOSE.”

In no event will Intersil be liable for special, collateral, incidental, or consequential damages in connection with or arising out of the use of this macro-model. Intersil reserves the right to make changes to the product and the macro-model without prior notice.

ISL28107, ISL28207, ISL28407

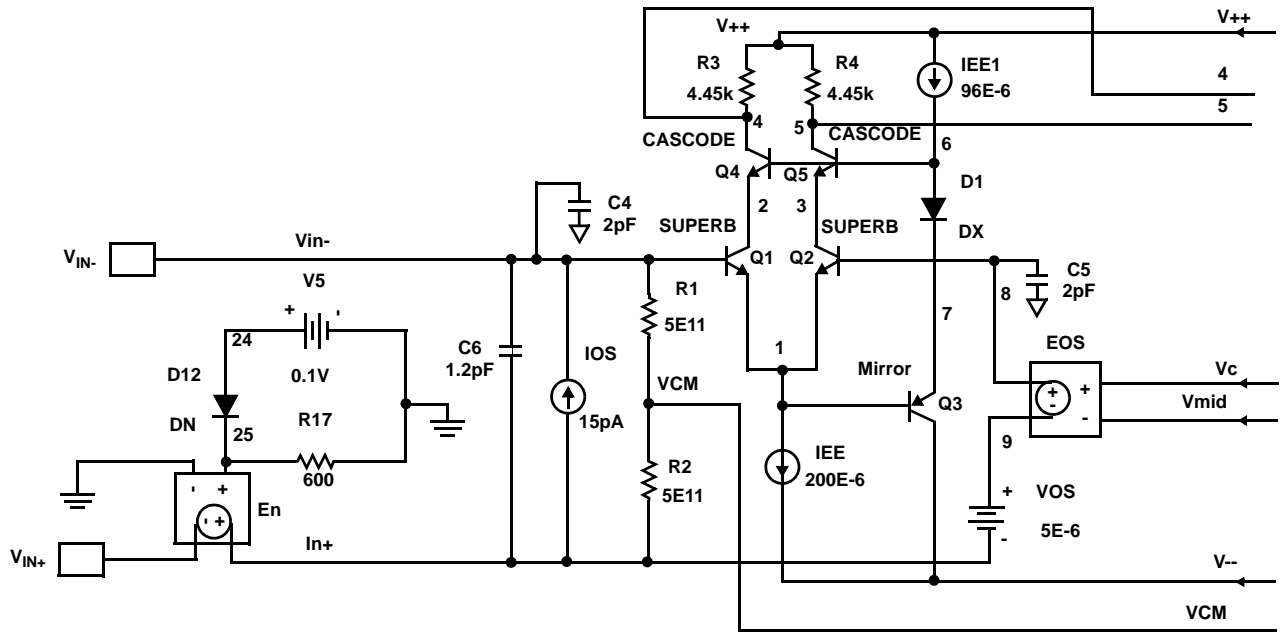

Voltage Noise

Input Stage

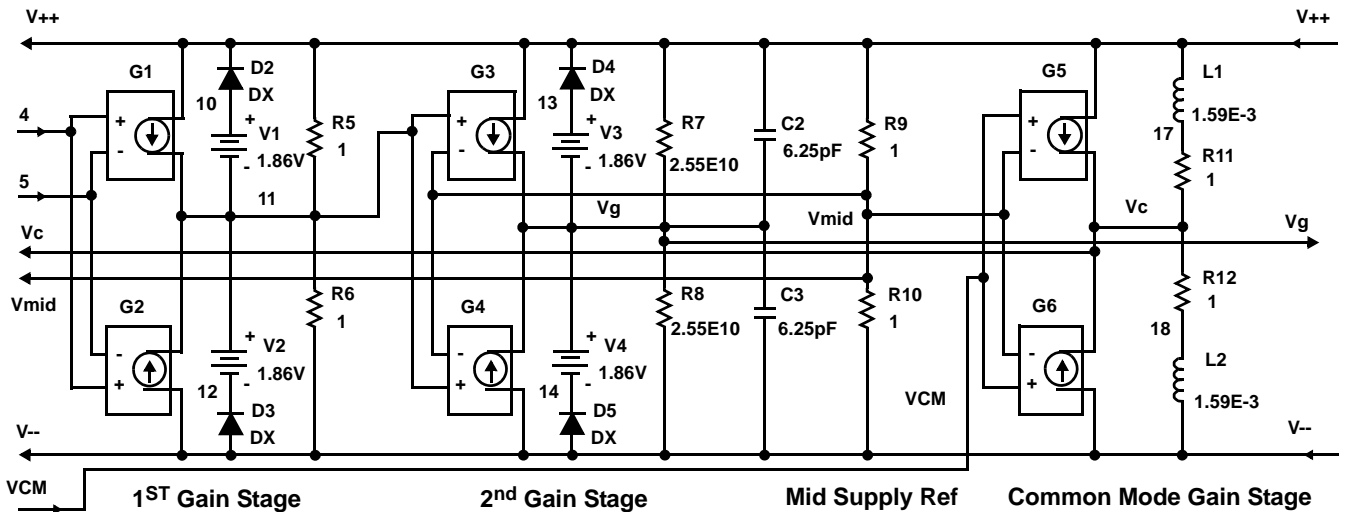

1ST Gain Stage

2nd Gain Stage

Mid Supply Ref

Common Mode Gain Stage

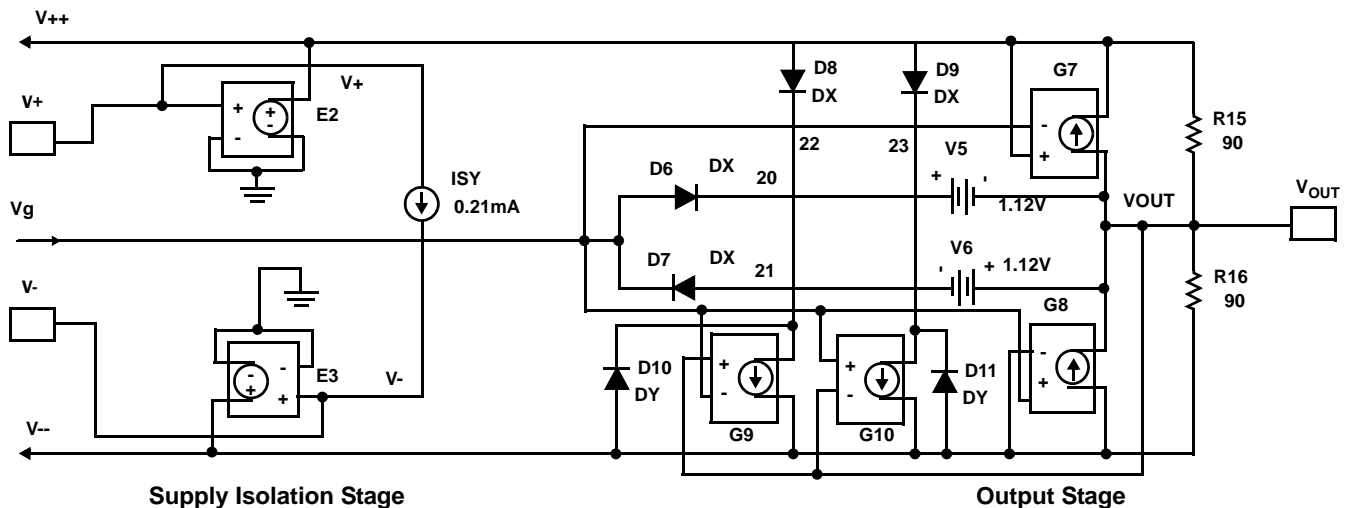

Supply Isolation Stage

Output Stage

FIGURE 56. SPICE SCHEMATIC

Characterization vs Simulation Results

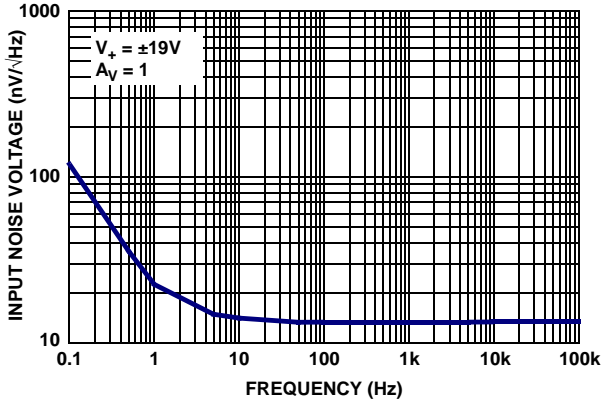

FIGURE 58. CHARACTERIZED INPUT NOISE VOLTAGE

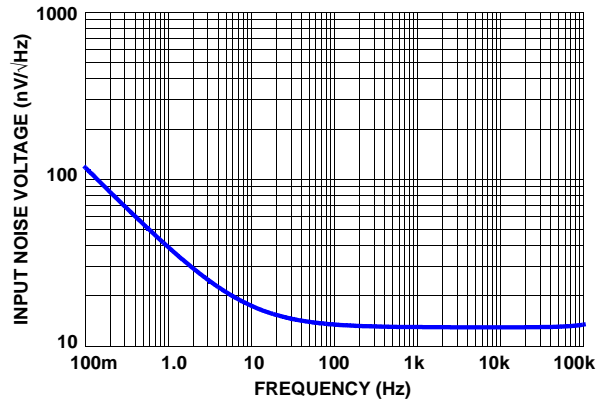

FIGURE 59. SIMULATED INPUT NOISE VOLTAGE

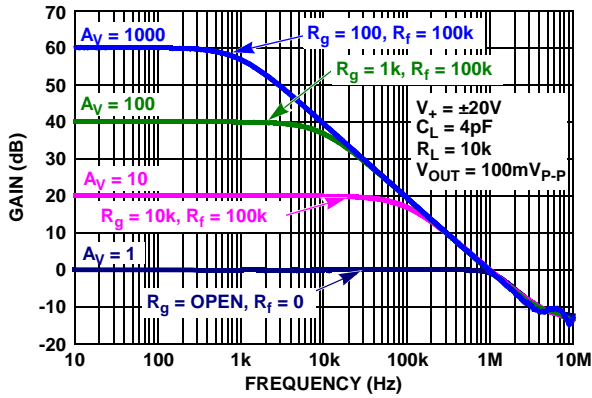

FIGURE 60. CHARACTERIZED CLOSED LOOP GAIN vs FREQUENCY

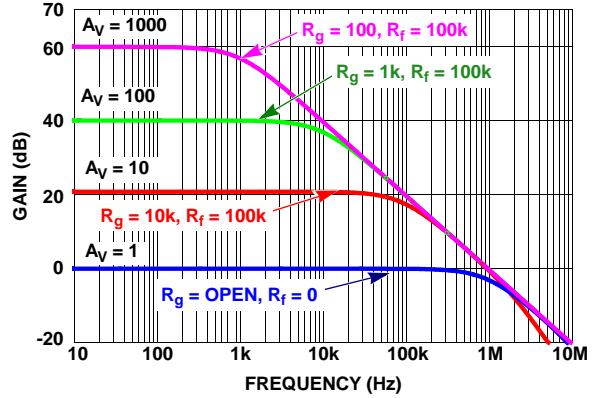

FIGURE 61. SIMULATED CLOSED LOOP GAIN vs FREQUENCY

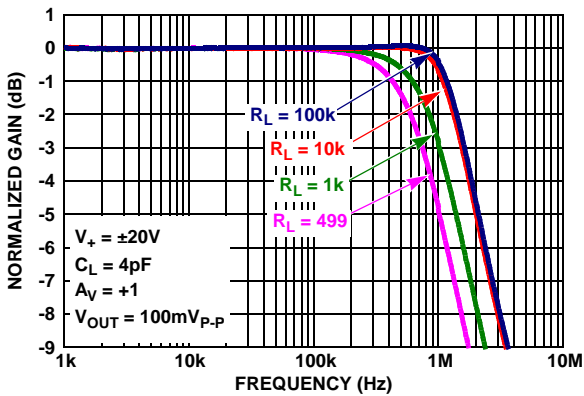

FIGURE 62. CHARACTERIZED CLOSED LOOP GAIN vs R_L

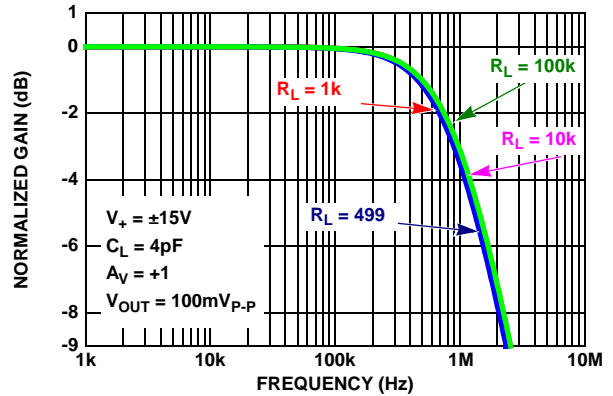

FIGURE 63. SIMULATED CLOSED LOOP GAIN vs R_L

Characterization vs Simulation Results (Continued)

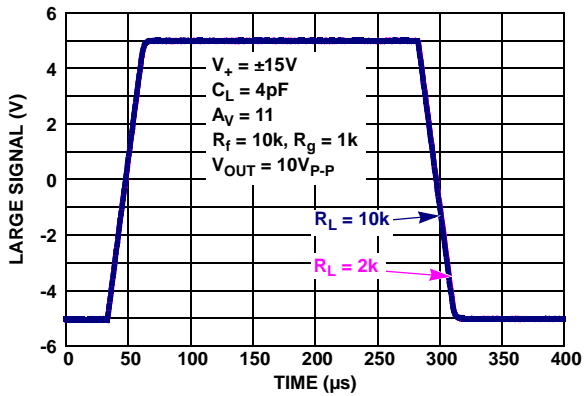

FIGURE 64. CHARACTERIZED LARGE SIGNAL 10V STEP RESPONSE

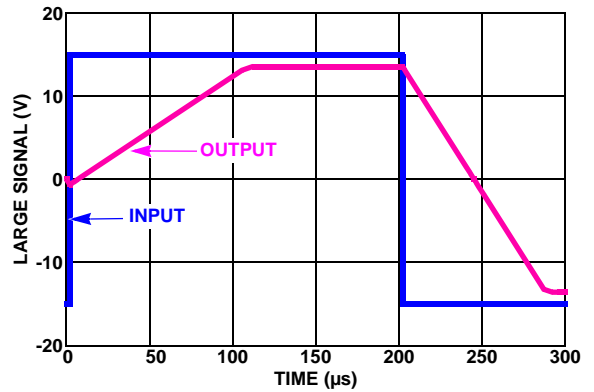

FIGURE 65. SIMULATED LARGE SIGNAL 10V STEP RESPONSE

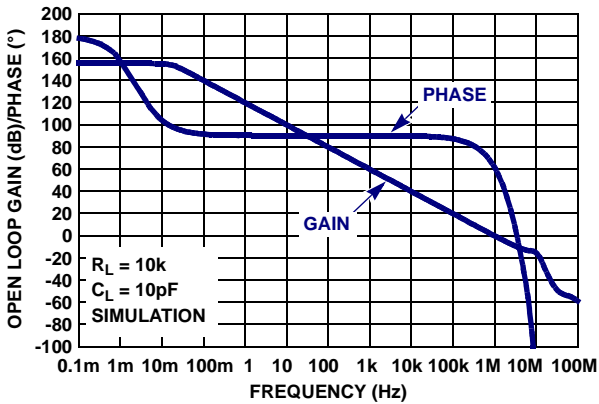

FIGURE 66. SIMULATED OPEN-LOOP GAIN, PHASE vs FREQUENCY

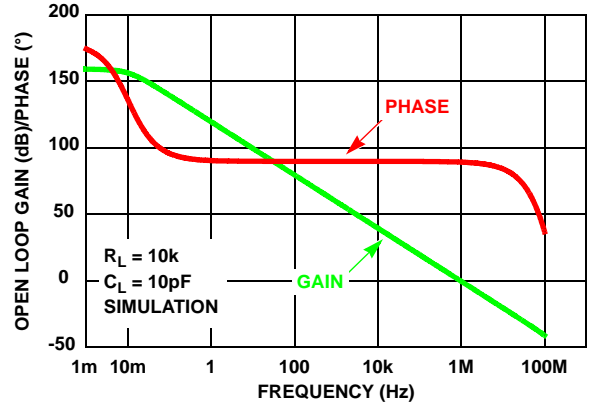

FIGURE 67. SIMULATED OPEN-LOOP GAIN, PHASE vs FREQUENCY

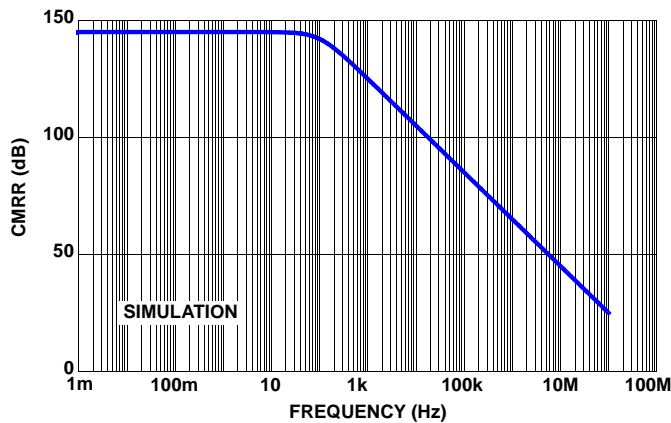

FIGURE 68. SIMULATED CMRR vs FREQUENCY

ISL28107, ISL28207, ISL28407

Revision History

The revision history provided is for informational purposes only and is believed to be accurate, but not warranted. Please go to the web to make sure that you have the latest revision.

DATE	REVISION	CHANGE
February 11, 2013	FN6631.7	Removed following parts from datasheet and updated accordingly throughout: ISL28407FRZ, 16 Ld QFN ISL28407FVZ, 14 Ld TSSOP ISL28407SOICEVAL1Z Parts were never released and were marked as <i>Coming Soon</i> Updated Package Outline Drawing M8.118B on page 29. Correct lead dimension in side view 2 from 0.15 - 0.05mm to 0.15±0.05mm.
February 21, 2012	FN6631.6	Added dual and quad to the "SPICE NET LIST" on page 22. Updated "Package Outline Drawing" on page 30. Added Thin to Package Title.
October 14, 2011	FN6631.5	Page 7: for ±15V and page 8 ±5V Elect Spec tables: 1. Ib for ISL28407 with Ta = -40C to 85C, change from +/-300pA to +/-330pA. 2. Ios for ISL28407 with Ta = -40C to 85C, change from +/-300pA to +/-330pA 3. TCib/TCIos for 28407 with Ta = -40C to 70C, change the typical from 0.03 pA/C to 0.3 pA/C. 4. Spec limits for TCib and TCIos for 0C to 70C: please change it from +/-1.4pA/C to +/-1.5pA/C and change test condition from "-40C to 70C" to "0C to 70C". For ISL28407 specs, change all "-40C to 70C" to "0C to 70C" 5. Spec limits for TCib and TCIos for -40C to 85C: please change it from +/-1.8pA/C to +/-2.0pA/C 6. Voh @ RI = 10kohm and 2kohm, please add "-40C to 70C under "test condition" and bold min. spec "13.2V and 13.1V" 7. Vol @ RI = 10kohm and 2kohm, please add "-40C to 70C under "test condition" to max. spec. "-13.2V and -13.1V" ESD Levels for ISL28407FBZ SOIC package HBM: 6kV, MM: 450V, CDM: 2kV <ul style="list-style-type: none"> • Pg 1 Description: <ul style="list-style-type: none"> - Last paragraph - changed "ISL28407 will be available" to "ISL28407 is available" • Pg 4 Ordering Information <ul style="list-style-type: none"> - Removed <i>Coming Soon</i> from ISL28407FBZ • Pg 6 Thermal Information: <ul style="list-style-type: none"> - 8 Ld TDFN (ISL28107) ThetaJA changed from 48 to 44 - 8 Ld TDFN (ISL28107) ThetaJC changed from 7 to 3 ±15V Electrical Specifications table <ul style="list-style-type: none"> - Added ISL28407 VOS spec limits - Added ISL28407 TCVOS spec limits • Pg 7 ±15V Electrical Specifications table <ul style="list-style-type: none"> - Added ISL28407 IB spec limits - Added ISL28407 TCIB spec limits - Added ISL28407 IOS spec limits - Added ISL28407 TCIOS spec limits - Converted AOL specs and limits from 3,000 V/mV and 40,000V/mV to 130dB and 152dB respectively • Pg 8 ±5V Electrical Specifications table <ul style="list-style-type: none"> - Added ISL28407 VOS spec limits • Pg 9 ±5V Electrical Specifications table <ul style="list-style-type: none"> - Added ISL28407 TCVOS spec limits - Added ISL28407 IB spec limits - Added ISL28407 TCIB spec limits - Added ISL28407 IOS spec limits - Added ISL28407 TCIOS spec limits - Converted AOL specs and limits from 3,000 V/mV and 40,000V/mV to 130 dB and 152 dB respectively • Pg 19 - Applications section "Using one Channel" <ul style="list-style-type: none"> - Changed title to "unused channels" and added text edits for clarity.

ISL28107, ISL28207, ISL28407

Revision History

The revision history provided is for informational purposes only and is believed to be accurate, but not warranted. Please go to the web to make sure that you have the latest revision. (Continued)

DATE	REVISION	CHANGE
August 26, 2011	FN6631.4	<ul style="list-style-type: none"> • On page 3, Pin Configurations, added ISL28207 MSOP pin diagram. • On page 4, Pin Descriptions, added ISL28207 MSOP to pin descriptions. • On page 5, Ordering Information, added ISL28207FUZ part and information. Updated ISL28107FBZ Pkg Dwg # from M8.118 to M8.118B. For ISL28107FRTZ and ISL28207FRTZ, updated Pkg Dwg # from L8.3x3A to L8.3x3K. For "Coming Soon" parts: ISL28407FBZ: changed Pkg Dwg # from M14.15 to MDP0027; ISL28407FVZ: changed Pkg Dwg # from M14.173 to MDP0044; ISL28407FRZ: changed Pkg Dwg # from 16.4x4 to L16.4x4E. ISL28207FRTZ: changed Part Marking from 207Z to 8207. For "Coming Soon" parts: ISL28407FBZ: changed Part Marking from 28407 to 28407 FBZ. ISL28407FVZ: changed Part Marking from 28407 to 28407 FVZ. ISL28407FRZ: changed Part Marking from 28407 to 407FRZ. Added "Coming Soon" ISL28407SOICEVAL1Z Evaluation Board. • On page 6, Thermal Information, added ISL28207 8Ld MSOP, and ISL28407 14 Ld SOIC and 16 Ld QFN thermal information. • On page 6 and page 8, Electrical Specifications: for V_{OS} spec for ISL28207 MSOP package, added -110μV MIN, +110 μV MAX, and -200μV MIN, +200μV MAX. For TCV_{OS} spec for ISL28207 MSOP package, added -0.9μV/°C MIN, +0.9μV/°C MAX. • On page 8 and page 8, Electrical Specifications: for TCI_B spec for ISL28207 MSOP package, added -1.5pA/°C MIN, +1.5pA/°C MAX. For TCI_{OS} spec for ISL28207 MSOP package, added -1.5pA/°C MIN, +1.5pA/°C MAX. • Updated to current Intersil datasheet template.
September 7, 2010	FN6631.3	<ol style="list-style-type: none"> 1. General changes: <ol style="list-style-type: none"> a. Added in ISL28407 Quad devices for SOIC, TSSOP and QFN packages. b. Added in TDFN packages for single ISL28107 and dual ISL28207 devices. c. Added in new VOS and TCVO limits for TDFN packages 2. Specific changes: <ol style="list-style-type: none"> a. On page 1 – Added in ISL28407 to title and front page info. Corrected Input Bias Current in Features from 60pA to 15pA (in order to match Spec Table) b. On page 3 - Added in ISL28107FRTZ, ISL28207FRTZ, ISL28407FBZ, ISL28407FVZ, and ISL28407FRZ packages to Ordering information. Added in -T7, T-13 & -T7A tape and reel extensions where applicable. c. On page 3 -Corrected part marking for ISL28207FRTZ parts from 207Z to 8207 d. On page 3 – Added in TDFN, 14 Ld SOIC, 14 Ld TSSOP and 16 Ld QFN to pin configurations. e. On page 4 – Updated “Pin Descriptions” with newly added packages. f. On page 6 – in “Thermal Information”, added in thermal packaging info & applicable notes for TDFN packages. g. On page 6 and page 7 Electrical Specifications Tables – Added two new line items for VOS spec. TDFN package ISL28107 limits $\pm 100\mu$V 25C and $\pm 190\mu$V full temp. TDFN package ISL28207 limits $\pm 100\mu$V 25C and $\pm 175\mu$V full temp. h. On page 6 and page 7 Electrical Specifications Table – Added two new line items for TCVO spec. TDFN package ISL28107 limits $\pm 0.9\mu$V/C full temp. TDFN package ISL28207 limits $\pm 0.75\mu$V/C. i. On page 30 to page 34 - Added in POD for L8.3x3A, M14.15, M14.173, and L16.4x4
March 9, 2010	FN6631.2	<ol style="list-style-type: none"> 1. Added MSOP package to the ordering information and added applicable POD M8.118 to end of datasheet 2. Separated each part number with it's own specific -T7 and -T13 suffix. Removed “Add -T7” or “-T13” suffix for Tape and Reel.” from Note 1. 3. Added MSOP to the Pin Configuration and Pin Descriptions 4. Updated ± 15 and $\pm 5V$ Electrical Specification table with the following edits: <ol style="list-style-type: none"> A) Separated VOS specs for SOIC and MSOP packages. Added new VOS specs for MSOP Grade package. B) Separated TCVO specs for SOIC and MSOP packages. Added new TCVO specs for MSOP package. 5. Added Theta JA and JC for the 8 Ld MSOP package. Added Theta JC values for both SOIC package options. Changed Theta JA for 8 Ld SOIC (ISL28207) from 115 to 105.
February 22, 2010		<ol style="list-style-type: none"> 1. Added “Related Literature*(see page 26)” on page 1. 2. Added Evaluation Boards to “Ordering Information” on page 3. 3. “Electrical Specifications” Tables, page 6 to page 10. Unbolded MIN/MAX specs with “$T_A = -40^\circ\text{C}$ to $+85^\circ\text{C}$” conditions (since only MIN/MAX specs with “$T_A = -40^\circ\text{C}$ to $+125^\circ\text{C}$” conditions should be bolded, per note in common conditions) 4. Corrected Note reference in I_{SC} parameter on page 7 and page 10 from Note 3 to Note 9.
November 10, 2009	FN6631.1	<ol style="list-style-type: none"> 1. Updated VOS, IB, and IOS electrical specifications. 2. Added Typical performance curves, Figures 3 through 32. 3. Output Short Circuit Current test condition has been clarified with Note 9. 4. Updated POD. 5. Added Spice Model, associated text and Figures 58 through 68. 6. Deleted old Figures 6, 7, 8, 10, 11 and 12. 7. Added Licence Statement on page 16 and referenced in spice model.

Revision History

The revision history provided is for informational purposes only and is believed to be accurate, but not warranted. Please go to the web to make sure that you have the latest revision. (Continued)

DATE	REVISION	CHANGE
June 5, 2009	FN6631.0	Initial Release

About Intersil

Intersil Corporation is a leader in the design and manufacture of high-performance analog, mixed-signal and power management semiconductors. The company's products address some of the fastest growing markets within the industrial and infrastructure, personal computing and high-end consumer markets. For more information about Intersil or to find out how to become a member of our winning team, visit our website and career page at www.intersil.com.

For a complete listing of Applications, Related Documentation and Related Parts, please see the respective product information page. Also, please check the product information page to ensure that you have the most updated datasheet: [ISL28107](#), [ISL28207](#) and [ISL28407](#).

To report errors or suggestions for this datasheet, please go to: www.intersil.com/askourstaff

Reliability reports are available from our website at: <http://rel.intersil.com/reports/search.php>

For additional products, see www.intersil.com/en/products.html

Intersil products are manufactured, assembled and tested utilizing ISO9000 quality systems as noted in the quality certifications found at www.intersil.com/en/support/qualandreliability.html

Intersil products are sold by description only. Intersil Corporation reserves the right to make changes in circuit design, software and/or specifications at any time without notice. Accordingly, the reader is cautioned to verify that data sheets are current before placing orders. Information furnished by Intersil is believed to be accurate and reliable. However, no responsibility is assumed by Intersil or its subsidiaries for its use; nor for any infringements of patents or other rights of third parties which may result from its use. No license is granted by implication or otherwise under any patent or patent rights of Intersil or its subsidiaries.

For information regarding Intersil Corporation and its products, see www.intersil.com

Package Outline Drawing (M8.15E)

M8.15E

8 LEAD NARROW BODY SMALL OUTLINE PLASTIC PACKAGE

Rev 0, 08/09

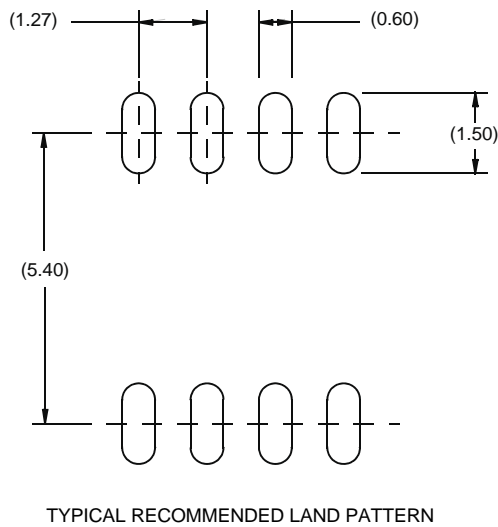
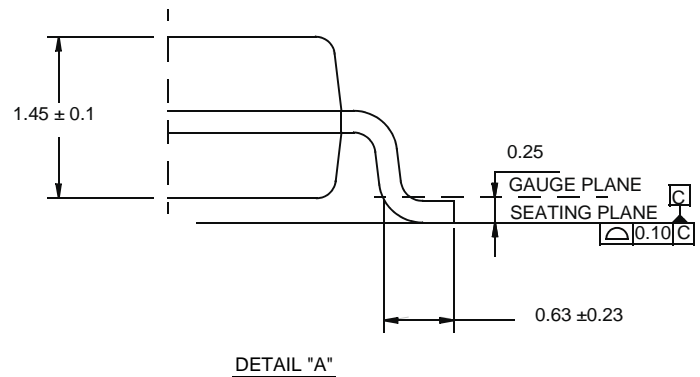
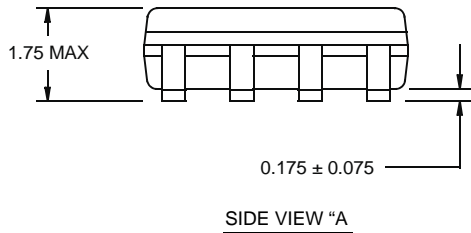
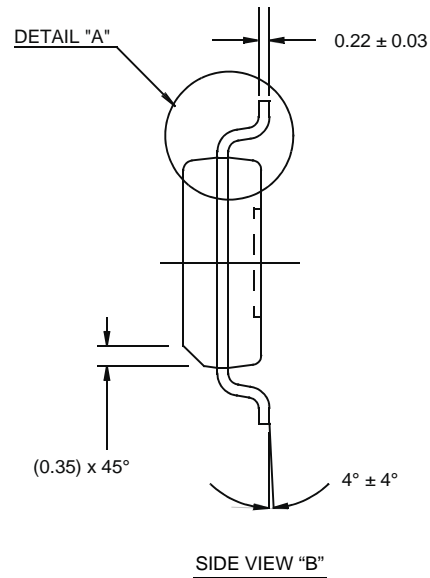
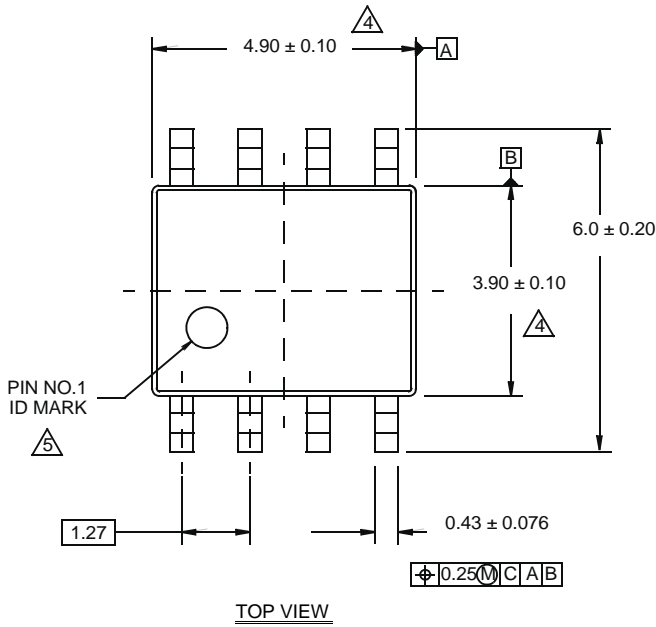

NOTES:

1. Dimensions are in millimeters.
Dimensions in () for Reference Only.
2. Dimensioning and tolerancing conform to AMSE Y14.5m-1994.
3. Unless otherwise specified, tolerance : Decimal ± 0.05
4. Dimension does not include interlead flash or protrusions.
Interlead flash or protrusions shall not exceed 0.25mm per side.
5. The pin #1 identifier may be either a mold or mark feature.
6. Reference to JEDEC MS-012.

Package Outline Drawing

M8.118B

8 LEAD MINI SMALL OUTLINE PLASTIC PACKAGE

Rev 1, 3/12

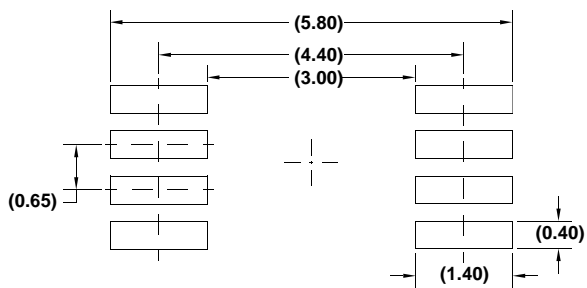
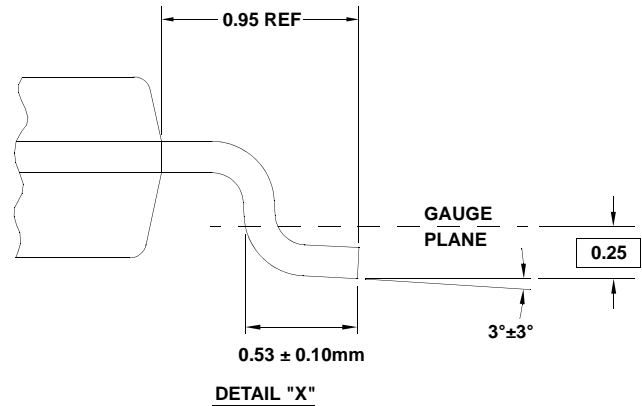
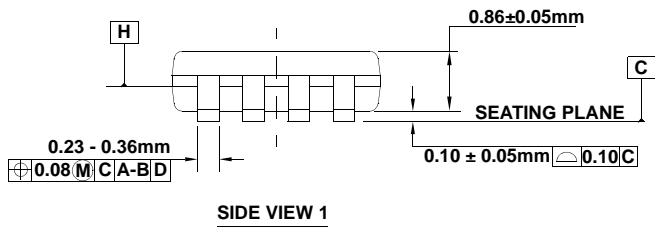
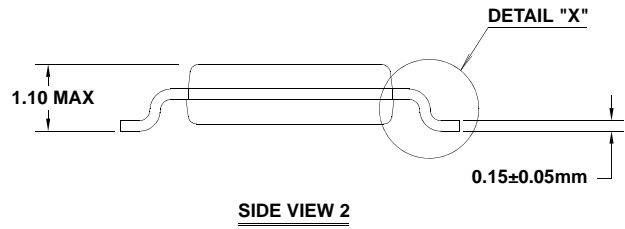
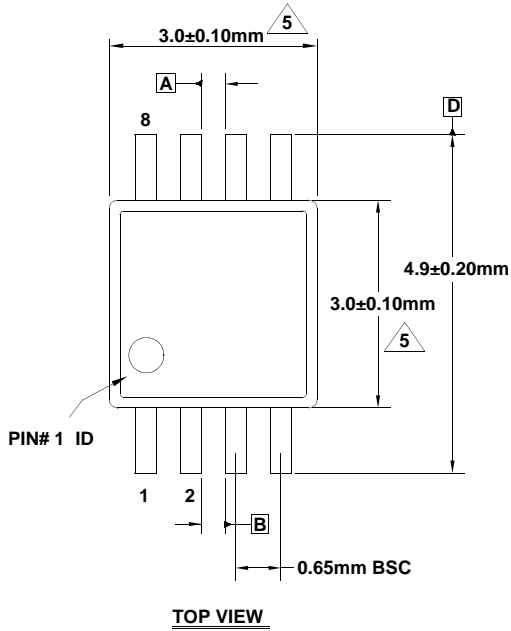

NOTES:

1. Dimensions are in millimeters.
2. Dimensioning and tolerancing conform to JEDEC MO-187-AA and AMSEY14.5m-1994.
3. Plastic or metal protrusions of 0.15mm max per side are not included.
4. Plastic interlead protrusions of 0.15mm max per side are not included.
5. Dimensions are measured at Datum Plane "H".
6. Dimensions in () are for reference only.

Package Outline Drawing

L8.3x3K

8 LEAD THIN DUAL FLAT NO-LEAD PLASTIC PACKAGE

Rev 1, 9/11

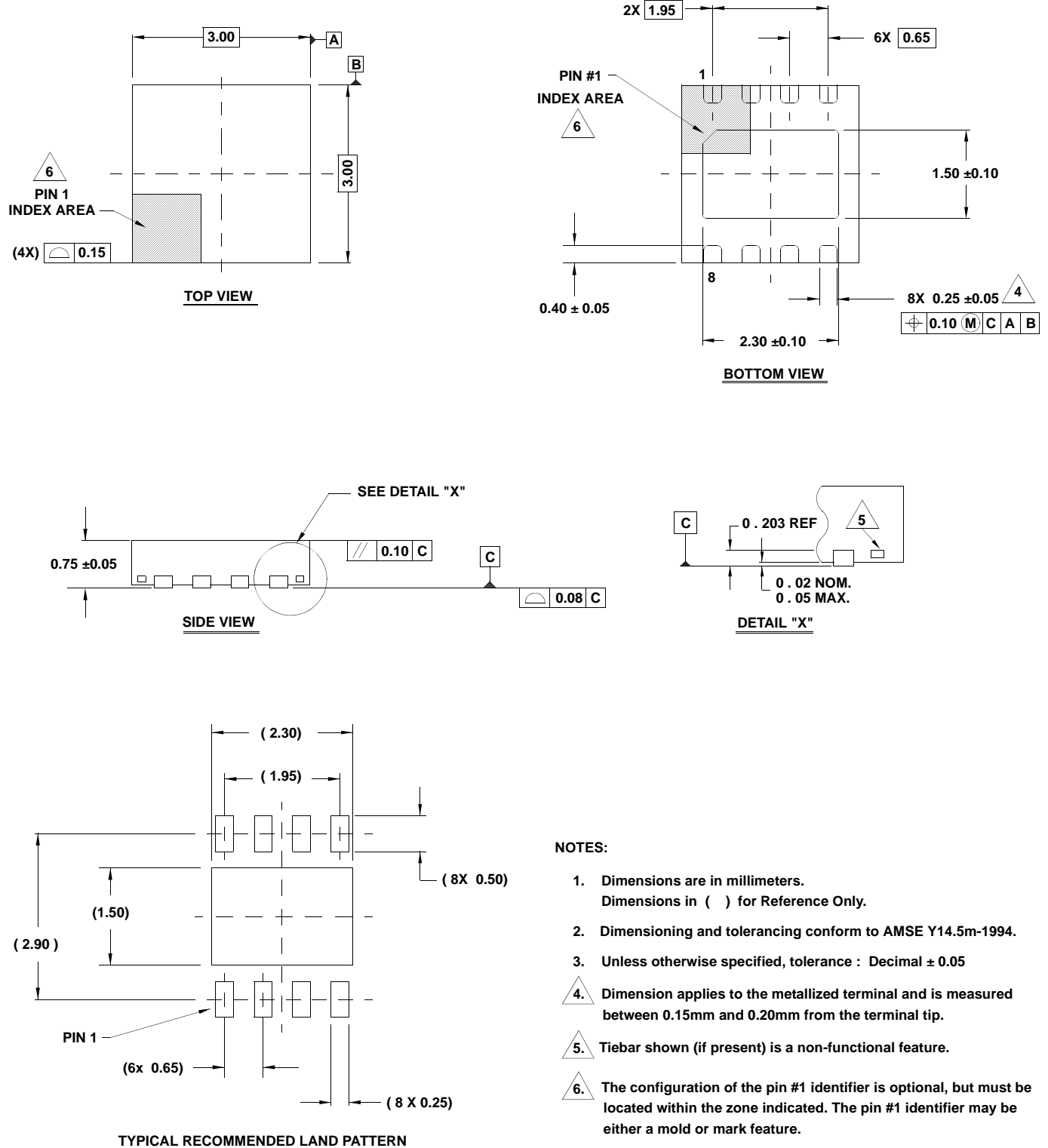

- NOTES:**
1. Dimensions are in millimeters.
Dimensions in () for Reference Only.
 2. Dimensioning and tolerancing conform to AMSE Y14.5m-1994.
 3. Unless otherwise specified, tolerance : Decimal ± 0.05
 4. Dimension applies to the metallized terminal and is measured between 0.15mm and 0.20mm from the terminal tip.
 5. Tiebar shown (if present) is a non-functional feature.
 6. The configuration of the pin #1 identifier is optional, but must be located within the zone indicated. The pin #1 identifier may be either a mold or mark feature.
 7. Compliant to JEDEC MO-229 WEEC-2 except for the foot length.

ISL28107, ISL28207, ISL28407

Small Outline Package Family (SO)

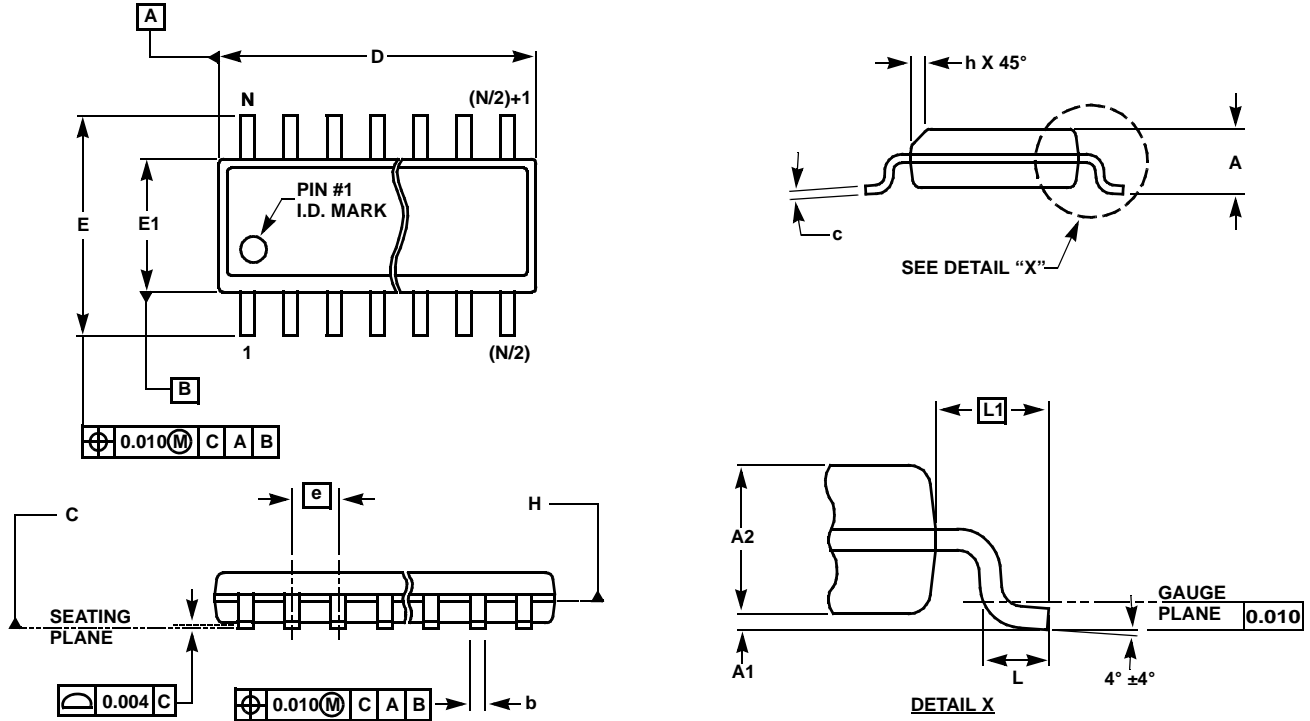

MDP0027

SMALL OUTLINE PACKAGE FAMILY (SO)

SYMBOL	INCHES							TOLERANCE	NOTES
	SO-8	SO-14	SO16 (0.150")	SO16 (0.300") (SOL-16)	SO20 (SOL-20)	SO24 (SOL- 24)	SO28 (SOL- 28)		
A	0.068	0.068	0.068	0.104	0.104	0.104	0.104	MAX	-
A1	0.006	0.006	0.006	0.007	0.007	0.007	0.007	± 0.003	-
A2	0.057	0.057	0.057	0.092	0.092	0.092	0.092	± 0.002	-
b	0.017	0.017	0.017	0.017	0.017	0.017	0.017	± 0.003	-
c	0.009	0.009	0.009	0.011	0.011	0.011	0.011	± 0.001	-
D	0.193	0.341	0.390	0.406	0.504	0.606	0.704	± 0.004	1, 3
E	0.236	0.236	0.236	0.406	0.406	0.406	0.406	± 0.008	-
E1	0.154	0.154	0.154	0.295	0.295	0.295	0.295	± 0.004	2, 3
e	0.050	0.050	0.050	0.050	0.050	0.050	0.050	Basic	-
L	0.025	0.025	0.025	0.030	0.030	0.030	0.030	± 0.009	-
L1	0.041	0.041	0.041	0.056	0.056	0.056	0.056	Basic	-
h	0.013	0.013	0.013	0.020	0.020	0.020	0.020	Reference	-
N	8	14	16	16	20	24	28	Reference	-

Rev. M 2/07

NOTES:

1. Plastic or metal protrusions of 0.006" maximum per side are not included.
2. Plastic interlead protrusions of 0.010" maximum per side are not included.
3. Dimensions "D" and "E1" are measured at Datum Plane "H".
4. Dimensioning and tolerancing per ASME Y14.5M-1994