

MOSFET - Power, Single N-Channel, TDFNW8

100 V, 4.2 mΩ, 178 A

NTMTSC4D2N10GTXG

Features

- Wide SOA for Linear Mode Operation
- Low $R_{DS(on)}$ to Minimize Conduction Losses
- High Peak UIS Current Capability for Ruggedness
- Small Footprint (8x8 mm) & Top Metal Cooling
- These Devices are Pb-Free, Halogen-Free / BFR-Free and are RoHS Compliant

Typical Applications

- 48 V Hot Swap System, Load Switch, Soft-Start, E-Fuse

MAXIMUM RATINGS ($T_J = 25^\circ\text{C}$ unless otherwise noted)

Parameter	Symbol	Value	Unit	
Drain-to-Source Voltage	V_{DSS}	100	V	
Gate-to-Source Voltage	V_{GS}	± 20	V	
Continuous Drain Current $R_{\theta JC}$ (Note 2)	Steady State	$T_C = 25^\circ\text{C}$	I_D 178	A
		$T_C = 100^\circ\text{C}$	125	
Power Dissipation $R_{\theta JC}$ (Note 2)	Steady State	$T_C = 25^\circ\text{C}$	P_D 267	W
		$T_C = 100^\circ\text{C}$	133	
Continuous Drain Current $R_{\theta JA}$ (Notes 1, 2)	Steady State	$T_A = 25^\circ\text{C}$	I_D 21	A
		$T_A = 100^\circ\text{C}$	15	
Power Dissipation $R_{\theta JA}$ (Notes 1, 2)	Steady State	$T_A = 25^\circ\text{C}$	P_D 3.9	W
		$T_A = 100^\circ\text{C}$	1.9	
Pulsed Drain Current	$T_A = 25^\circ\text{C}, t_p = 10 \mu\text{s}$	I_{DM} 2558	A	
Operating Junction and Storage Temperature Range	T_J, T_{stg}	-55 to +175	$^\circ\text{C}$	
Source Current (Body Diode)	I_S	222	A	
Single Pulse Drain-to-Source Avalanche Energy ($I_{L(pk)} = 100 \text{ A}, L = 0.1 \text{ mH}$)	E_{AS}	506	mJ	
Lead Temperature for Soldering Purposes (1/8" from case for 10 s)	T_L	260	$^\circ\text{C}$	

Stresses exceeding those listed in the Maximum Ratings table may damage the device. If any of these limits are exceeded, device functionality should not be assumed, damage may occur and reliability may be affected.

THERMAL RESISTANCE MAXIMUM RATINGS

Parameter	Symbol	Value	Unit
Junction-to-Case - Steady State (Note 2)	$R_{\theta JC}$	0.56	$^\circ\text{C}/\text{W}$
Junction-to-Top Source - Steady State (Note 2)	$R_{\theta JC}$	0.86	
Junction-to-Ambient - Steady State (Note 2)	$R_{\theta JA}$	38	

1. Surface-mounted on FR4 board using a 1 in², 1 oz. Cu pad.
2. The entire application environment impacts the thermal resistance values shown, they are not constants and are only valid for the particular conditions noted.

$V_{(BR)DSS}$	$R_{DS(ON) MAX}$	$I_D MAX$
100 V	4.2 mΩ @ 10 V	178 A

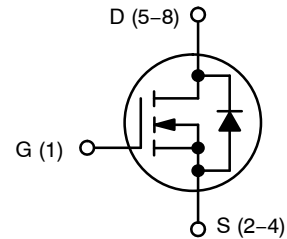

N-CHANNEL MOSFET

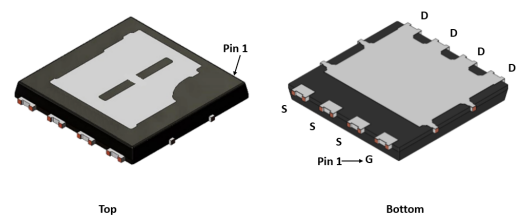

TDFNW8
DUAL COOL
CASE 507AS

MARKING DIAGRAM

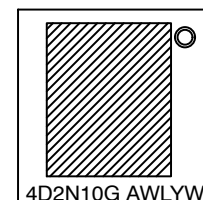

4D2N10G = Specific Device Code
A = Assembly Location
WL = Wafer Lot Code
Y = Year Code
W = Work Week Code

ORDERING INFORMATION

See detailed ordering, marking and shipping information in the package dimensions section on page 5 of this data sheet.

NTMTSC4D2N10GTXG

ELECTRICAL CHARACTERISTICS (T_J = 25°C unless otherwise specified)

Parameter	Symbol	Test Condition	Min	Typ	Max	Unit
-----------	--------	----------------	-----	-----	-----	------

OFF CHARACTERISTICS

Drain-to-Source Breakdown Voltage	V _{(BR)DSS}	V _{GS} = 0 V, I _D = 250 μA	100			V
Drain-to-Source Breakdown Voltage Temperature Coefficient	V _{(BR)DSS} /T _J	I _D = 250 μA, ref to 25°C		84.1		mV/°C
Zero Gate Voltage Drain Current	I _{DSS}	V _{GS} = 0 V, V _{DS} = 80 V	T _J = 25°C		1.0	μA
			T _J = 150°C		100	
Gate-to-Source Leakage Current	I _{GSS}	V _{DS} = 0 V, V _{GS} = ±20 V			±100	nA

ON CHARACTERISTICS (Note 3)

Gate Threshold Voltage	V _{GS(TH)}	V _{GS} = V _{DS} , I _D = 450 μA	2.0		4.0	V
Negative Threshold Temperature Coefficient	V _{GS(TH)} /T _J	I _D = 450 μA, ref to 25°C		-9.24		mV/°C
Drain-to-Source On Resistance	R _{DS(on)}	V _{GS} = 10 V, I _D = 88 A		2.9	4.2	mΩ
Forward Transconductance	g _{FS}	V _{DS} = 5 V, I _D = 88 A		61		S
Gate Resistance	R _G	T _A = 25°C		0.9		Ω

CHARGES, CAPACITANCES & GATE RESISTANCE

Input Capacitance	C _{ISS}	V _{GS} = 0 V, f = 1 MHz, V _{DS} = 50 V		10450		pF
Output Capacitance	C _{OSS}			1050		
Reverse Transfer Capacitance	C _{RSS}			158		
Total Gate Charge	Q _{G(TOT)}	V _{GS} = 10 V, V _{DS} = 50 V; I _D = 88 A		159		nC
Threshold Gate Charge	Q _{G(TH)}			27.7		
Gate-to-Source Charge	Q _{GS}			61		
Gate-to-Drain Charge	Q _{GD}			38		

SWITCHING CHARACTERISTICS (Note 4)

Turn-On Delay Time	t _{d(ON)}	V _{GS} = 10 V, V _{DS} = 50 V, I _D = 88 A, R _G = 4.7 Ω		40		ns
Rise Time	t _r			36		
Turn-Off Delay Time	t _{d(OFF)}			76		
Fall Time	t _f			26		

DRAIN-SOURCE DIODE CHARACTERISTICS

Forward Diode Voltage	V _{SD}	V _{GS} = 0 V, I _S = 88 A	T _J = 25°C		0.82	1.2	V
			T _J = 125°C		0.70		
Reverse Recovery Time	t _{RR}	V _{GS} = 0 V, dI _S /dt = 300 A/μs, I _S = 44 A		46.7		ns	
Reverse Recovery Charge	Q _{RR}			224		nC	
Reverse Recovery Time	t _{RR}	V _{GS} = 0 V, dI _S /dt = 1000 A/μs, I _S = 44 A		46.1		ns	
Reverse Recovery Charge	Q _{RR}			595		nC	

Product parametric performance is indicated in the Electrical Characteristics for the listed test conditions, unless otherwise noted. Product performance may not be indicated by the Electrical Characteristics if operated under different conditions.

3. Pulse Test: pulse width ≤ 300 μs, duty cycle ≤ 2%.

4. Switching characteristics are independent of operating junction temperatures.

NTMTSC4D2N10GTXG

TYPICAL CHARACTERISTICS

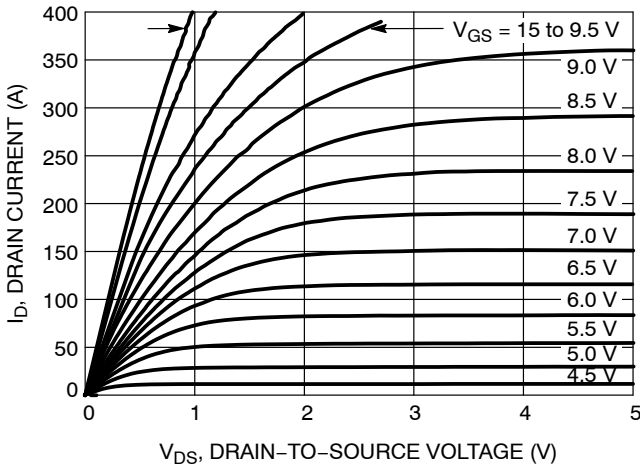

Figure 1. On-Region Characteristics

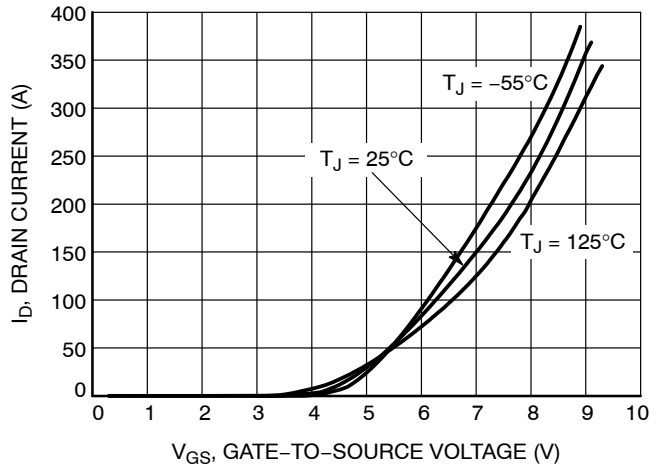

Figure 2. Transfer Characteristics

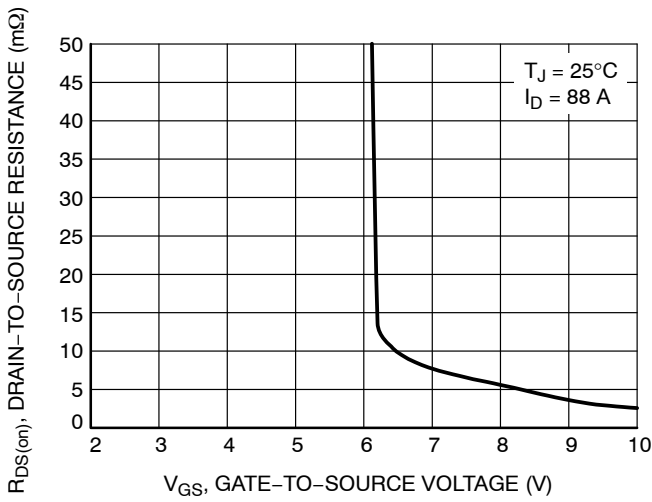

Figure 3. On-Resistance vs. Gate-to-Source Voltage

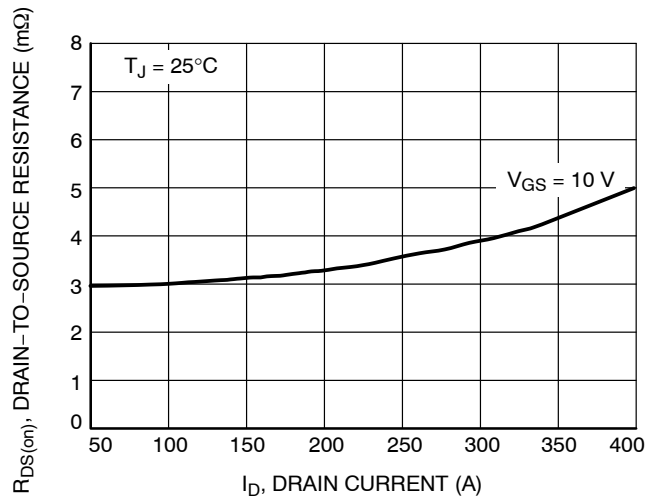

Figure 4. On-Resistance vs. Drain Current

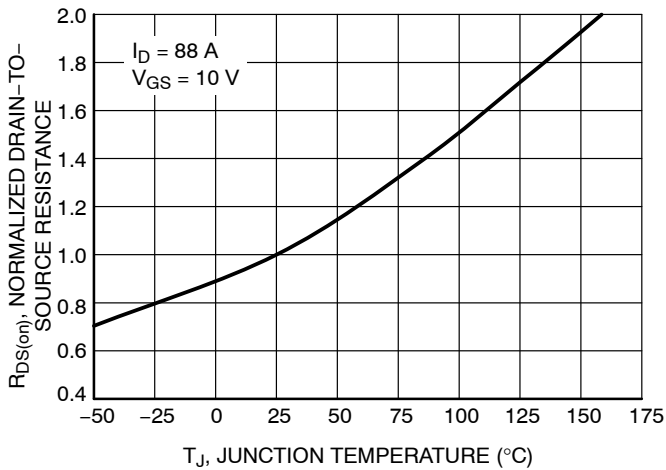

Figure 5. On-Resistance Variation with Temperature

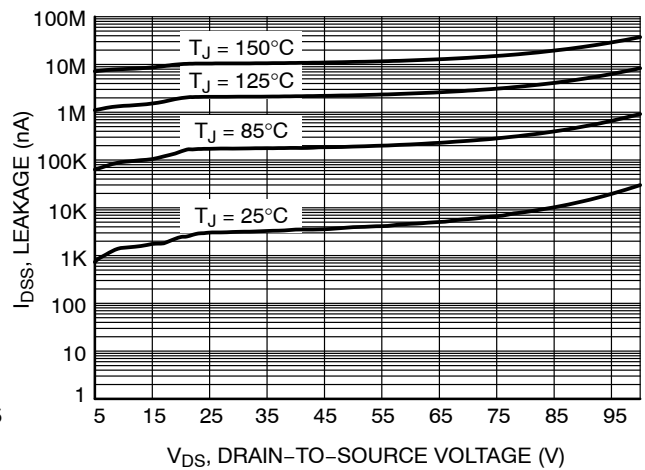

Figure 6. Drain-to-Source Leakage Current vs. Voltage

NTMTSC4D2N10GTXG

TYPICAL CHARACTERISTICS

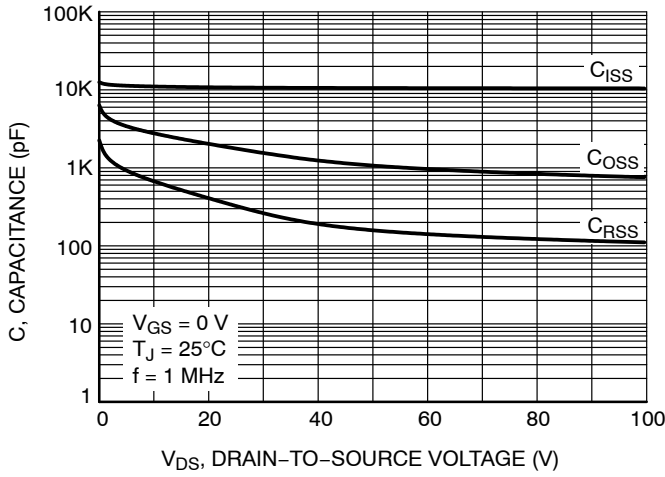

Figure 7. Capacitance Variation

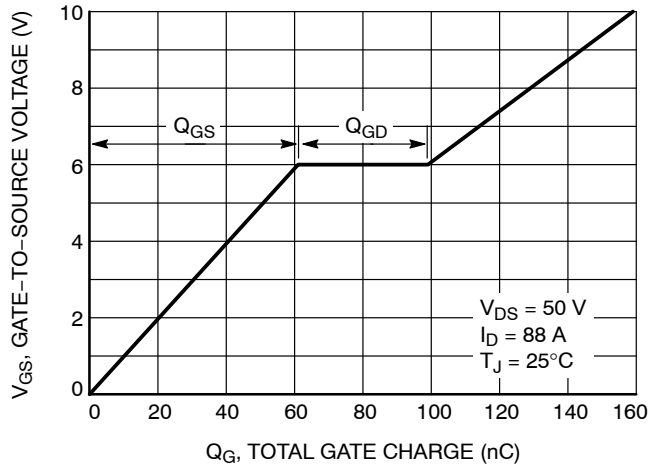

Figure 8. Gate-to-Source Voltage vs. Total Charge

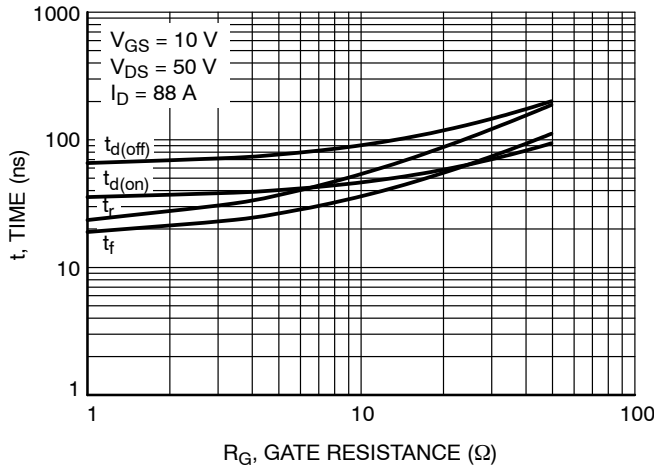

Figure 9. Resistive Switching Time Variation vs. Gate Resistance

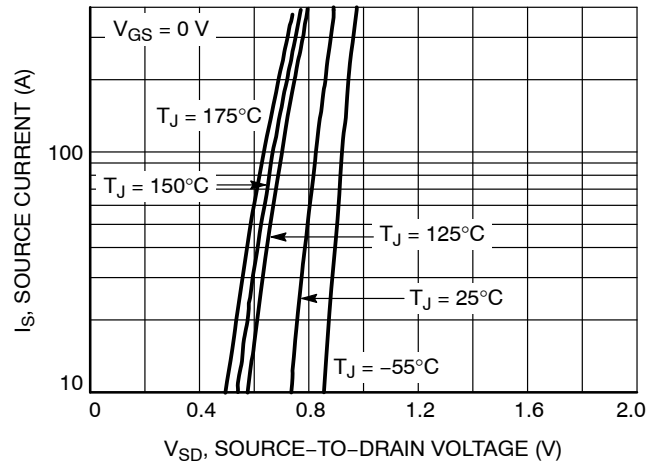

Figure 10. Diode Forward Voltage vs. Current

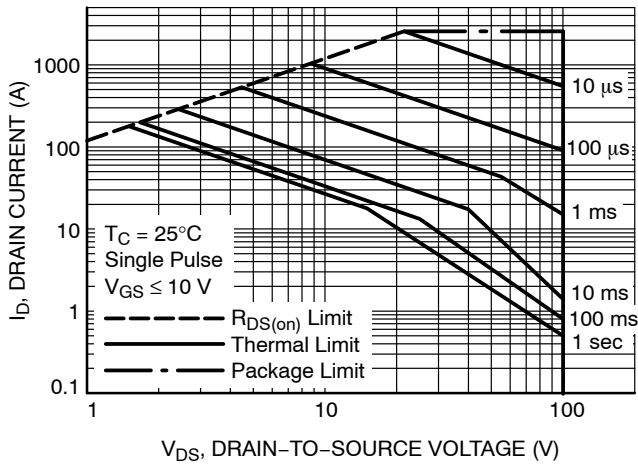

Figure 11. Maximum Rated Forward Biased Safe Operating Area

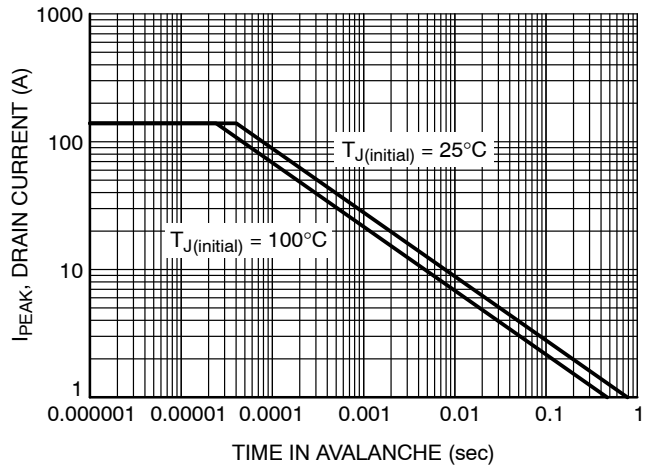

Figure 12. Maximum Drain Current vs. Time in Avalanche

NTMTSC4D2N10GTXG

TYPICAL CHARACTERISTICS

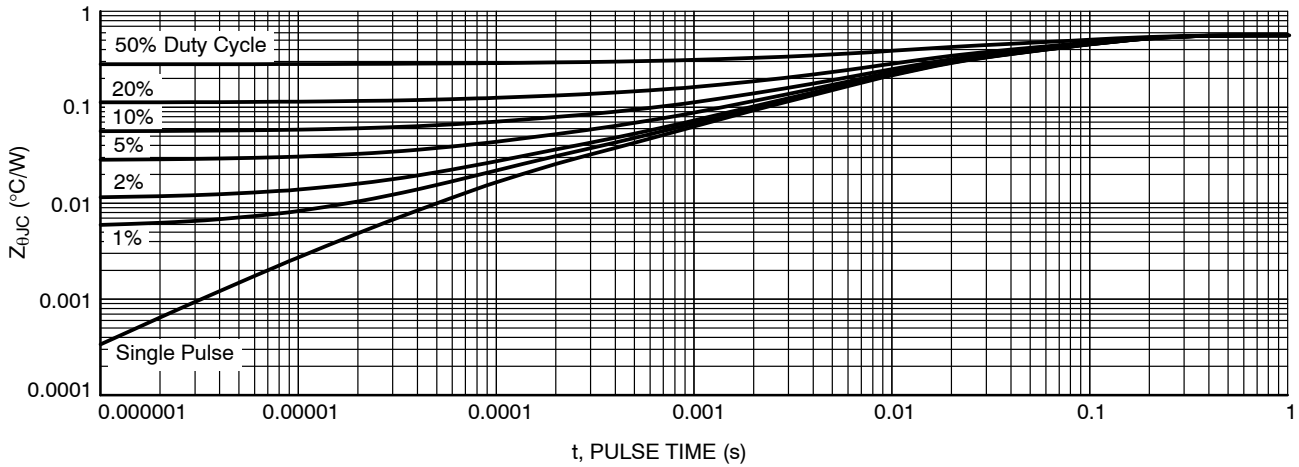

Figure 13. Junction-to-Ambient Transient Thermal Response

DEVICE ORDERING INFORMATION

Device	Marking	Package	Shipping [†]
NTMTSC4D2N10GTXG	4D2N10G	TDFNW8 (Pb-Free)	3000 / Tape & Reel

[†]For information on tape and reel specifications, including part orientation and tape sizes, please refer to our Tape and Reel Packaging Specifications Brochure, BRD8011/D.

MECHANICAL CASE OUTLINE PACKAGE DIMENSIONS



TDFNW8 8.3x8.4, 2P, DUAL COOL, OPTION 3 CASE 507AS ISSUE B

DATE 29 MAR 2021

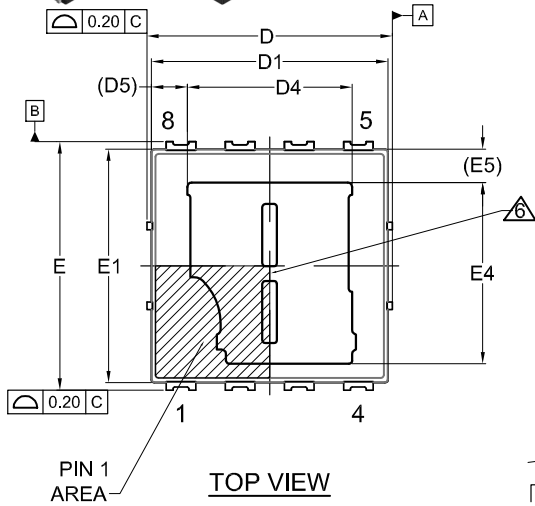
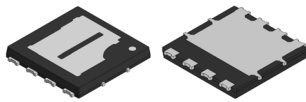

TOP VIEW

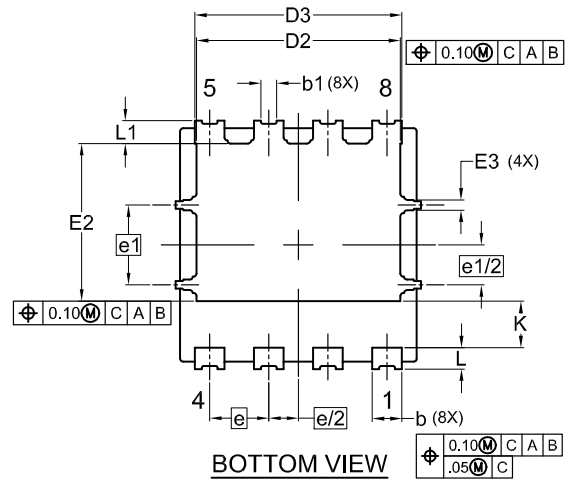

BOTTOM VIEW

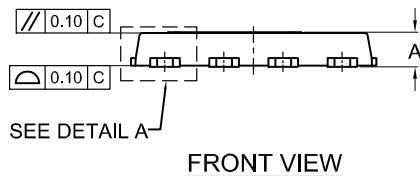

FRONT VIEW

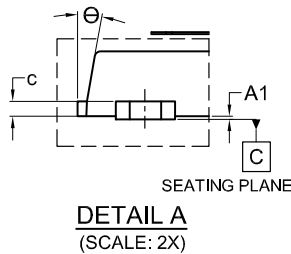

DETAIL A
(SCALE: 2X)

NOTES:

1. DIMENSIONING & TOLERANCING PER ASME Y14.5M, 2009.
2. CONTROLLING DIMENSION: MILLIMETERS
3. COPLANARITY APPLIES TO THE EXPOSED PADS AS WELL AS THE TERMINALS.
4. DIMENSIONS D1 AND E1 DO NOT INCLUDE MOLD FLASH, PROTRUSIONS, OR GATE BURRS.
5. SEATING PLANE IS DEFINED BY THE TERMINALS. "A1" IS DEFINED AS THE DISTANCE FROM THE SEATING PLANE TO THE LOWEST POINT ON THE PACKAGE BODY.
6. SLOT PARTITION IS OPTIONAL.

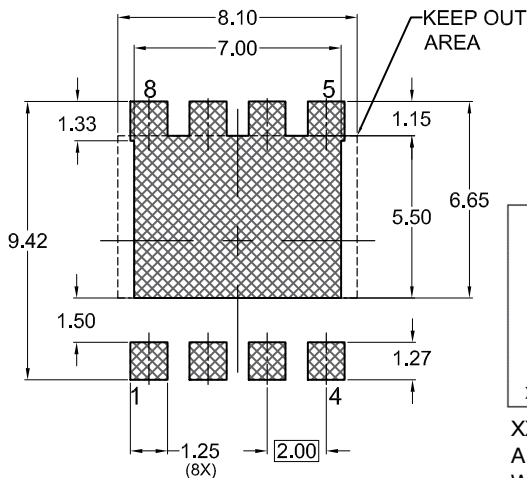

RECOMMENDED LAND PATTERN

(For additional information on our Pb-free strategy and soldering details, please download the ON Semiconductor Soldering and Mounting Techniques Reference Manual, SOLDERRM/D.)

GENERIC MARKING DIAGRAM*

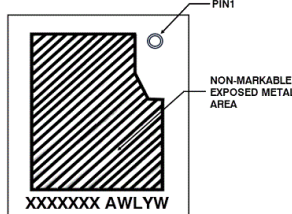

XXXX = Specific Device Code
A = Assembly Location
WL = Wafer Lot Code
Y = Year Code
W = Work Week Code

*This information is generic. Please refer to device data sheet for actual part marking. Pb-Free indicator, "G" or microdot "•", may or may not be present. Some products may not follow the Generic Marking.

DIM	MILLIMETERS		
	MIN.	NOM.	MAX.
A	0.82	0.92	1.02
A1	0.00	---	0.05
b	0.90	1.00	1.10
b1	0.35	0.45	0.55
c	0.23	0.28	0.33
D	8.20	8.30	8.40
D1	7.90	8.00	8.10
D2	6.80	6.90	7.00
D3	6.90	7.00	7.10
D4	5.52	5.67	5.82
D5	1.16 REF		
E	8.30	8.40	8.50
E1	7.80	7.90	8.00
E2	5.24	5.34	5.44
E3	0.25	0.35	0.45
E4	6.08	6.23	6.38
E5	1.13 REF		
e	2.00 BSC		
e/2	1.00 BSC		
e1	2.70 BSC		
e1/2	1.35 BSC		
K	1.50	1.57	1.70
L	0.64	0.74	0.84
L1	0.67	0.77	0.87
θ	0°	---	12°

DOCUMENT NUMBER:	98AON95716G	Electronic versions are uncontrolled except when accessed directly from the Document Repository. Printed versions are uncontrolled except when stamped "CONTROLLED COPY" in red.
DESCRIPTION:	TDFNW8 8.3x8.4, 2P, DUAL COOL, OPTION 3	PAGE 1 OF 1

onsemi and ONSEMI are trademarks of Semiconductor Components Industries, LLC dba onsemi or its subsidiaries in the United States and/or other countries. onsemi reserves the right to make changes without further notice to any products herein. onsemi makes no warranty, representation or guarantee regarding the suitability of its products for any particular purpose, nor does onsemi assume any liability arising out of the application or use of any product or circuit, and specifically disclaims any and all liability, including without limitation special, consequential or incidental damages. onsemi does not convey any license under its patent rights nor the rights of others.

onsemi, **Onsemi**, and other names, marks, and brands are registered and/or common law trademarks of Semiconductor Components Industries, LLC dba "**onsemi**" or its affiliates and/or subsidiaries in the United States and/or other countries. **onsemi** owns the rights to a number of patents, trademarks, copyrights, trade secrets, and other intellectual property. A listing of **onsemi**'s product/patent coverage may be accessed at www.onsemi.com/site/pdf/Patent-Marking.pdf. **onsemi** reserves the right to make changes at any time to any products or information herein, without notice. The information herein is provided "as-is" and **onsemi** makes no warranty, representation or guarantee regarding the accuracy of the information, product features, availability, functionality, or suitability of its products for any particular purpose, nor does **onsemi** assume any liability arising out of the application or use of any product or circuit, and specifically disclaims any and all liability, including without limitation special, consequential or incidental damages. Buyer is responsible for its products and applications using **onsemi** products, including compliance with all laws, regulations and safety requirements or standards, regardless of any support or applications information provided by **onsemi**. "Typical" parameters which may be provided in **onsemi** data sheets and/or specifications can and do vary in different applications and actual performance may vary over time. All operating parameters, including "Typicals" must be validated for each customer application by customer's technical experts. **onsemi** does not convey any license under any of its intellectual property rights nor the rights of others. **onsemi** products are not designed, intended, or authorized for use as a critical component in life support systems or any FDA Class 3 medical devices or medical devices with a same or similar classification in a foreign jurisdiction or any devices intended for implantation in the human body. Should Buyer purchase or use **onsemi** products for any such unintended or unauthorized application, Buyer shall indemnify and hold **onsemi** and its officers, employees, subsidiaries, affiliates, and distributors harmless against all claims, costs, damages, and expenses, and reasonable attorney fees arising out of, directly or indirectly, any claim of personal injury or death associated with such unintended or unauthorized use, even if such claim alleges that **onsemi** was negligent regarding the design or manufacture of the part. **onsemi** is an Equal Opportunity/Affirmative Action Employer. This literature is subject to all applicable copyright laws and is not for resale in any manner.

ADDITIONAL INFORMATION

TECHNICAL PUBLICATIONS:

Technical Library: www.onsemi.com/design/resources/technical-documentation
onsemi Website: www.onsemi.com

ONLINE SUPPORT: www.onsemi.com/support

For additional information, please contact your local Sales Representative at www.onsemi.com/support/sales