

# MMUN2111LT1 Series

Preferred Devices

## Bias Resistor Transistors

### PNP Silicon Surface Mount Transistors with Monolithic Bias Resistor Network

This new series of digital transistors is designed to replace a single device and its external resistor bias network. The BRT (Bias Resistor Transistor) contains a single transistor with a monolithic bias network consisting of two resistors; a series base resistor and a base-emitter resistor. The BRT eliminates these individual components by integrating them into a single device. The use of a BRT can reduce both system cost and board space. The device is housed in the SOT-23 package which is designed for low power surface mount applications.

#### Features

- Simplifies Circuit Design
- Reduces Board Space
- Reduces Component Count
- The SOT-23 package can be soldered using wave or reflow. The modified gull-winged leads absorb thermal stress during soldering eliminating the possibility of damage to the die.
- Available in 8 mm embossed tape and reel.
- Pb-Free Packages are Available

#### MAXIMUM RATINGS (T<sub>A</sub> = 25°C unless otherwise noted)

Rating	Symbol	Value	Unit
Collector-Base Voltage	V <sub>CB0</sub>	50	Vdc
Collector-Emitter Voltage	V <sub>CEO</sub>	50	Vdc
Collector Current	I <sub>C</sub>	100	mAdc

#### THERMAL CHARACTERISTICS

Characteristic	Symbol	Max	Unit
Total Device Dissipation T <sub>A</sub> = 25°C Derate above 25°C	P <sub>D</sub>	246 (Note 1) 400 (Note 2) 1.5 (Note 1) 2.0 (Note 2)	mW °C/W
Thermal Resistance, Junction-to-Ambient	R <sub>θJA</sub>	508 (Note 1) 311 (Note 2)	°C/W
Thermal Resistance, Junction-to-Lead	R <sub>θJL</sub>	174 (Note 1) 208 (Note 2)	°C/W
Junction and Storage, Temperature Range	T <sub>J</sub> , T <sub>stg</sub>	-55 to +150	°C

Maximum ratings are those values beyond which device damage can occur. Maximum ratings applied to the device are individual stress limit values (not normal operating conditions) and are not valid simultaneously. If these limits are exceeded, device functional operation is not implied, damage may occur and reliability may be affected.

1. FR-4 @ Minimum Pad
2. FR-4 @ 1.0 x 1.0 inch Pad



ON Semiconductor®

<http://onsemi.com>

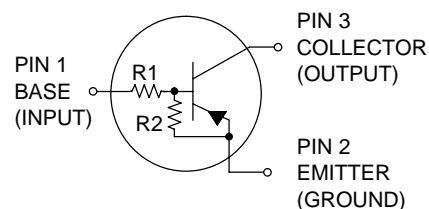

#### MARKING DIAGRAM

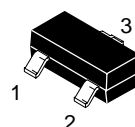

SOT-23  
CASE 318  
STYLE 6

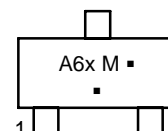

A6x = Device Code  
x = A - L (Refer to page 2)  
M = Date Code\*  
▪ = Pb-Free Package

(Note: Microdot may be in either location)

\*Date Code orientation may vary depending upon manufacturing location.

#### ORDERING INFORMATION

Device	Package	Shipping†
MMUN21xxLT1	SOT-23	3000/Tape & Reel
MMUN21xxLT1G	SOT-23 (Pb-Free)	3000/Tape & Reel
MMUN21xxLT3	SOT-23	10000/Tape & Reel
MMUN21xxLT3G	SOT-23 (Pb-Free)	10000/Tape & Reel

†For information on tape and reel specifications, including part orientation and tape sizes, please refer to our Tape and Reel Packaging Specifications Brochure, BRD8011/D.

#### DEVICE MARKING INFORMATION

See specific marking information in the device marking table on page 2 of this data sheet.

Preferred devices are recommended choices for future use and best overall value.

## MMUN2111LT1 Series

### DEVICE MARKING AND RESISTOR VALUES

Device*	Package	Marking	R1 (K)	R2 (K)	Shipping
MMUN2111LT1, G MMUN2111LT3, G	SOT-23	A6A	10	10	3000/Tape & Reel 10,000/Tape & Reel
MMUN2112LT1, G	SOT-23	A6B	22	22	3000/Tape & Reel
MMUN2113LT1, G MMUN2113LT3, G	SOT-23	A6C	47	47	3000/Tape & Reel 10,000/Tape & Reel
MMUN2114LT1, G	SOT-23	A6D	10	47	3000/Tape & Reel
MMUN2115LT1, G (Note 3)	SOT-23	A6E	10	∞	3000/Tape & Reel
MMUN2116LT1, G (Note 3)	SOT-23	A6F	4.7	∞	3000/Tape & Reel
MMUN2130LT1, G (Note 3)	SOT-23	A6G	1.0	1.0	3000/Tape & Reel
MMUN2131LT1, G (Note 3)	SOT-23	A6H	2.2	2.2	3000/Tape & Reel
MMUN2132LT1, G (Note 3)	SOT-23	A6J	4.7	4.7	3000/Tape & Reel
MMUN2133LT1, G (Note 3)	SOT-23	A6K	4.7	47	3000/Tape & Reel
MMUN2134LT1, G (Note 3)	SOT-23	A6L	22	47	3000/Tape & Reel

\*The "G" suffix indicates Pb-Free package available.

3. New devices. Updated curves to follow in subsequent data sheets.

### ELECTRICAL CHARACTERISTICS ( $T_A = 25^\circ\text{C}$ unless otherwise noted)

Characteristic	Symbol	Min	Typ	Max	Unit
<b>OFF CHARACTERISTICS</b>					
Collector-Base Cutoff Current ( $V_{CB} = 50\text{ V}$ , $I_E = 0$ )	$I_{CBO}$	–	–	100	nAdc
Collector-Emitter Cutoff Current ( $V_{CE} = 50\text{ V}$ , $I_B = 0$ )	$I_{CEO}$	–	–	500	nAdc
Emitter-Base Cutoff Current ( $V_{EB} = 6.0\text{ V}$ , $I_C = 0$ )	MMUN2111LT1	–	–	0.5	mAdc
	MMUN2112LT1	–	–	0.2	
	MMUN2113LT1	–	–	0.1	
	MMUN2114LT1	–	–	0.2	
	MMUN2115LT1	–	–	0.9	
	MMUN2116LT1	–	–	1.9	
	MMUN2130LT1	–	–	4.3	
	MMUN2131LT1	–	–	2.3	
	MMUN2132LT1	–	–	1.5	
	MMUN2133LT1	–	–	0.18	
MMUN2134LT1	–	–	0.13		
Collector-Base Breakdown Voltage ( $I_C = 10\ \mu\text{A}$ , $I_E = 0$ )	$V_{(BR)CBO}$	50	–	–	Vdc
Collector-Emitter Breakdown Voltage (Note 4) ( $I_C = 2.0\text{ mA}$ , $I_B = 0$ )	$V_{(BR)CEO}$	50	–	–	Vdc

4. Pulse Test: Pulse Width < 300  $\mu\text{s}$ , Duty Cycle < 2.0%

# MMUN2111LT1 Series

## ELECTRICAL CHARACTERISTICS (T<sub>A</sub> = 25°C unless otherwise noted) (Continued)

Characteristic	Symbol	Min	Typ	Max	Unit	
<b>ON CHARACTERISTICS</b> (Note 5)						
DC Current Gain (V <sub>CE</sub> = 10 V, I <sub>C</sub> = 5.0 mA)	MMUN2111LT1 MMUN2112LT1 MMUN2113LT1 MMUN2114LT1 MMUN2115LT1 MMUN2116LT1 MMUN2130LT1 MMUN2131LT1 MMUN2132LT1 MMUN2133LT1 MMUN2134LT1	h <sub>FE</sub>	35 60 80 80 160 160 3.0 8.0 15 80 80	60 100 140 140 250 250 5.0 15 27 140 130	– – – – – – – – – – –	
Collector-Emitter Saturation Voltage (I <sub>C</sub> = 10 mA, I <sub>E</sub> = 0.3 mA) (I <sub>C</sub> = 10 mA, I <sub>B</sub> = 5 mA) (I <sub>C</sub> = 10 mA, I <sub>B</sub> = 1 mA)	MMUN2130LT1/MMUN2131LT1 MMUN2115LT1/MMUN2116LT1/ MMUN2132LT1/MMUN2133LT1/MMUN2134LT1	V <sub>CE(sat)</sub>	–	–	0.25	Vdc
Output Voltage (on) (V <sub>CC</sub> = 5.0 V, V <sub>B</sub> = 2.5 V, R <sub>L</sub> = 1.0 kΩ)	MMUN2111LT1 MMUN2112LT1 MMUN2114LT1 MMUN2115LT1 MMUN2116LT1 MMUN2130LT1 MMUN2131LT1 MMUN2132LT1 MMUN2133LT1 MMUN2134LT1 MMUN2113LT1	V <sub>OL</sub>	– – – – – – – – – – –	– – – – – – – – – – –	0.2 0.2 0.2 0.2 0.2 0.2 0.2 0.2 0.2 0.2 0.2	Vdc
Output Voltage (off) (V <sub>CC</sub> = 5.0 V, V <sub>B</sub> = 0.5 V, R <sub>L</sub> = 1.0 kΩ) (V <sub>CC</sub> = 5.0 V, V <sub>B</sub> = 0.25 V, R <sub>L</sub> = 1.0 kΩ)  (V <sub>CC</sub> = 5.0 V, V <sub>B</sub> = 0.050 V, R <sub>L</sub> = 1.0 kΩ)	MMUN2115LT1 MMUN2116LT1 MMUN2131LT1 MMUN2132LT1 MMUN2130LT1	V <sub>OH</sub>	4.9	–	–	Vdc
Input Resistor	MMUN2111LT1 MMUN2112LT1 MMUN2113LT1 MMUN2114LT1 MMUN2115LT1 MMUN2116LT1 MMUN2130LT1 MMUN2131LT1 MMUN2132LT1 MMUN2133LT1 MMUN2134LT1	R <sub>1</sub>	7.0 15.4 32.9 7.0 7.0 3.3 0.7 1.5 3.3 3.3 15.4	10 22 47 10 10 4.7 1.0 2.2 4.7 4.7 22	13 28.6 61.1 13 13 6.1 1.3 2.9 6.1 6.1 28.6	k Ω
Resistor Ratio	MMUN2111LT1/MMUN2112LT1/MMUN2113LT1 MMUN2114LT1 MMUN2115LT1/MMUN2116LT1 MMUN2130LT1/MMUN2131LT1/MMUN2132LT1 MMUN2133LT1	R <sub>1</sub> /R <sub>2</sub>	0.8 0.17 – 0.8 0.055	1.0 0.21 – 1.0 0.1	1.2 0.25 – 1.2 0.185	

5. Pulse Test: Pulse Width < 300 μs, Duty Cycle < 2.0%

# MMUN2111LT1 Series

## TYPICAL ELECTRICAL CHARACTERISTICS MMUN2111LT1

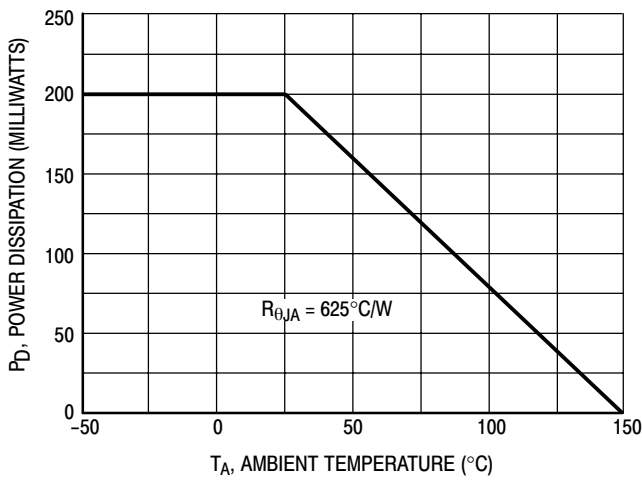

Figure 1. Derating Curve

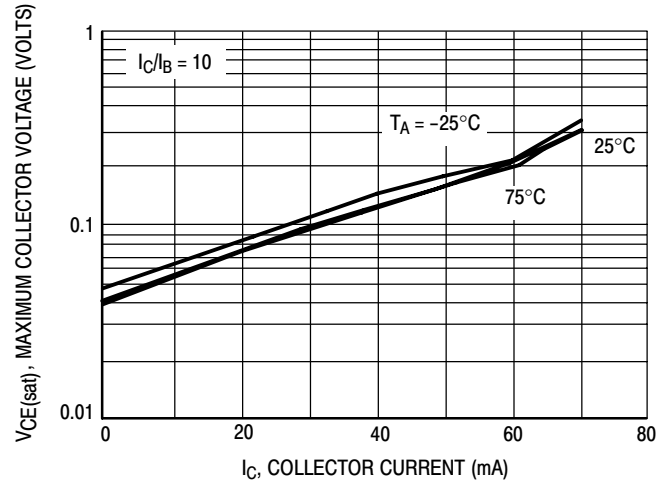

Figure 2. V<sub>CE(sat)</sub> versus I<sub>C</sub>

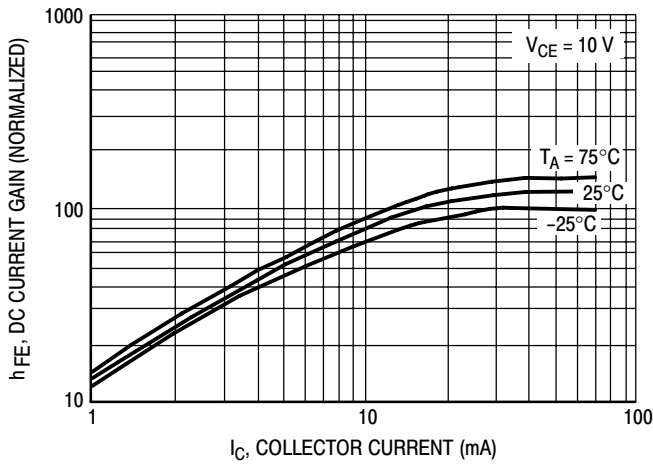

Figure 3. DC Current Gain

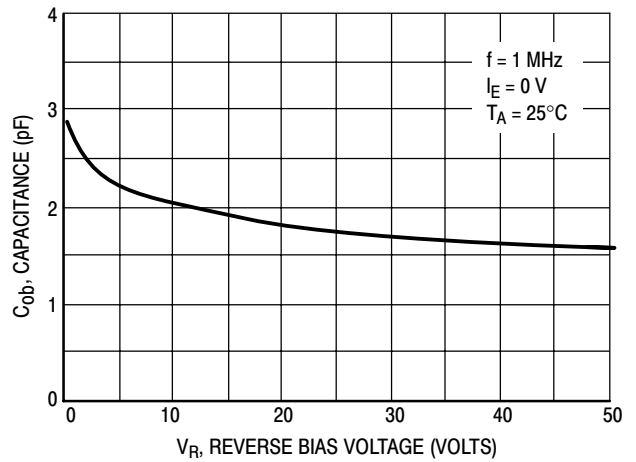

Figure 4. Output Capacitance

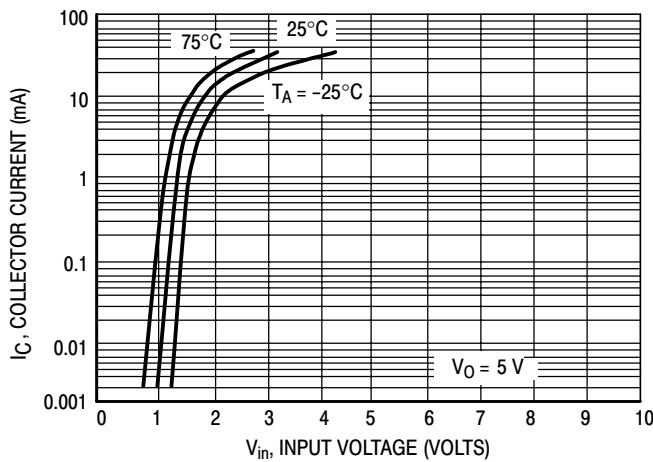

Figure 5. Output Current versus Input Voltage

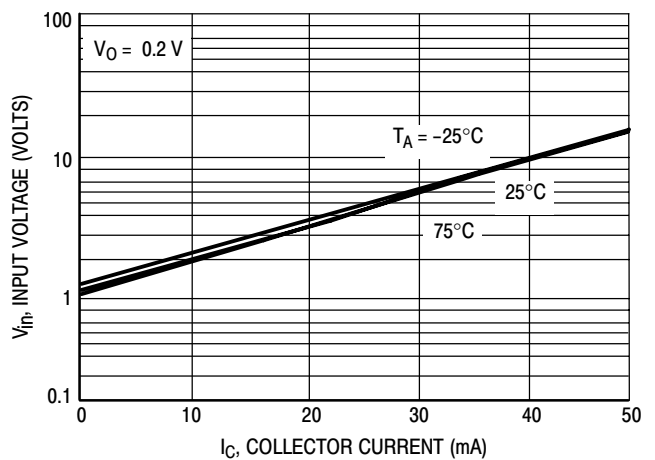

Figure 6. Input Voltage versus Output Current

# MMUN2111LT1 Series

## TYPICAL ELECTRICAL CHARACTERISTICS MMUN2112LT1

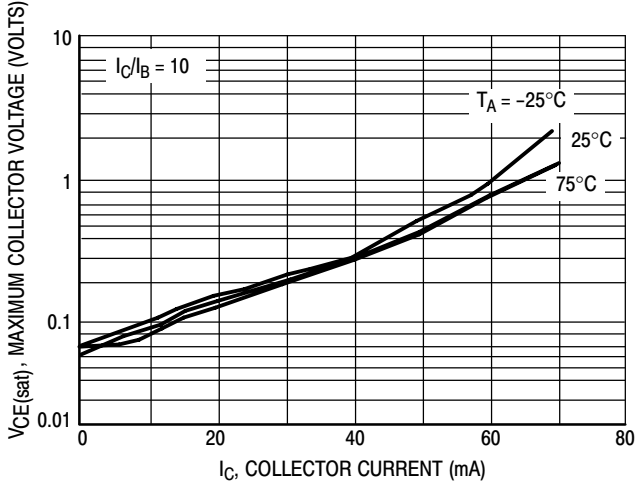

Figure 7.  $V_{CE(sat)}$  versus  $I_C$

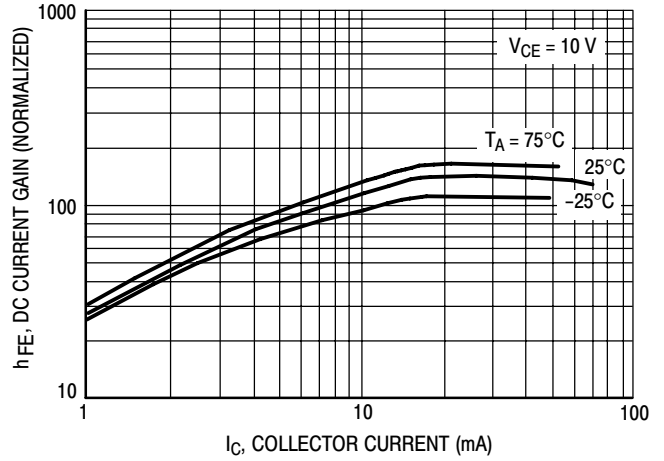

Figure 8. DC Current Gain

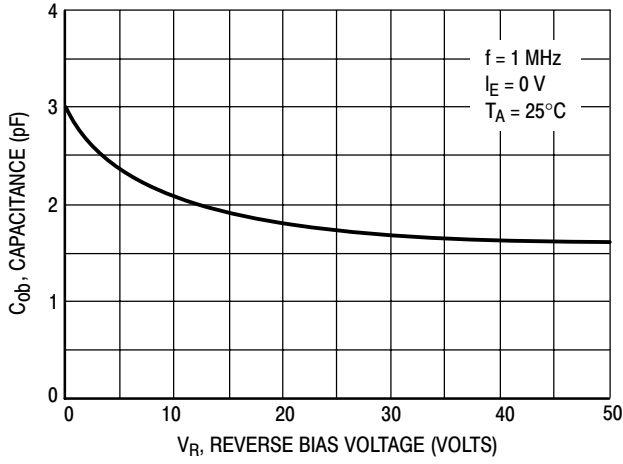

Figure 9. Output Capacitance

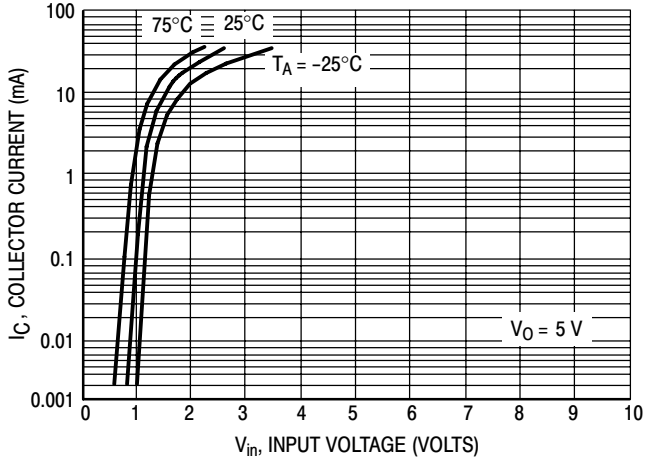

Figure 10. Output Current versus Input Voltage

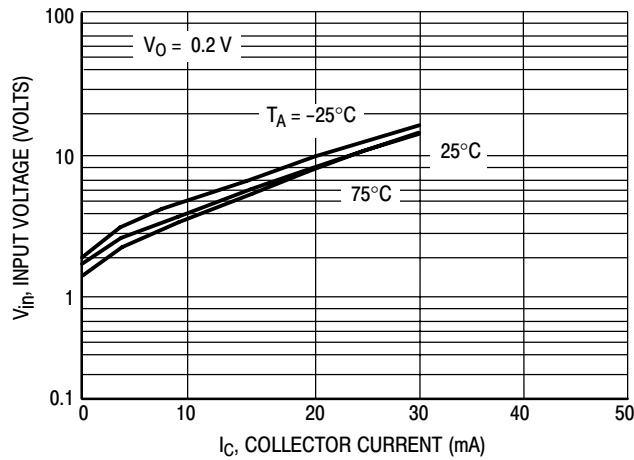

Figure 11. Input Voltage versus Output Current

# MMUN2111LT1 Series

## TYPICAL ELECTRICAL CHARACTERISTICS MMUN2113LT1

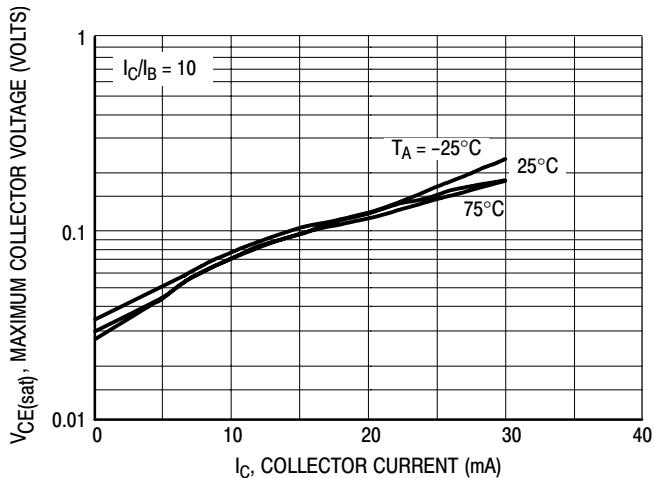

Figure 12.  $V_{CE(sat)}$  versus  $I_C$

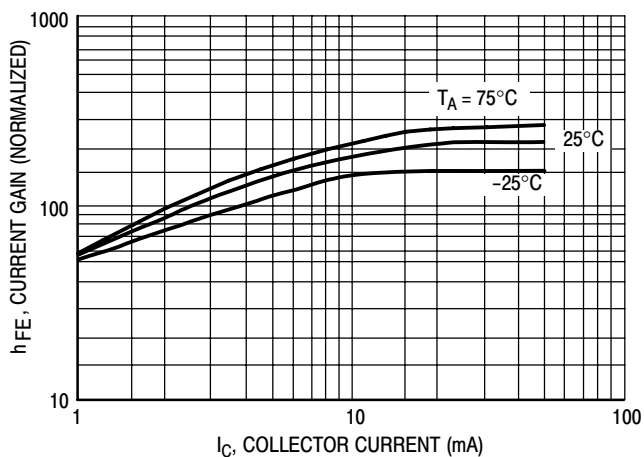

Figure 13. DC Current Gain

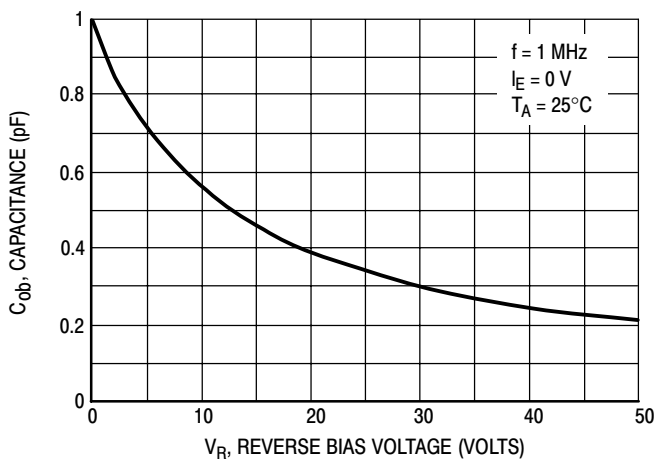

Figure 14. Output Capacitance

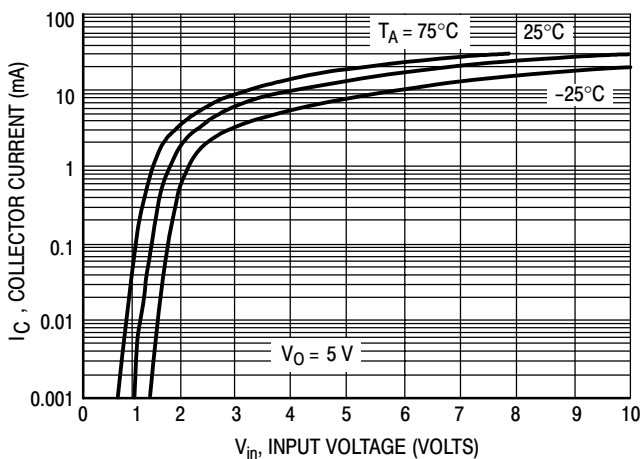

Figure 15. Output Current versus Input Voltage

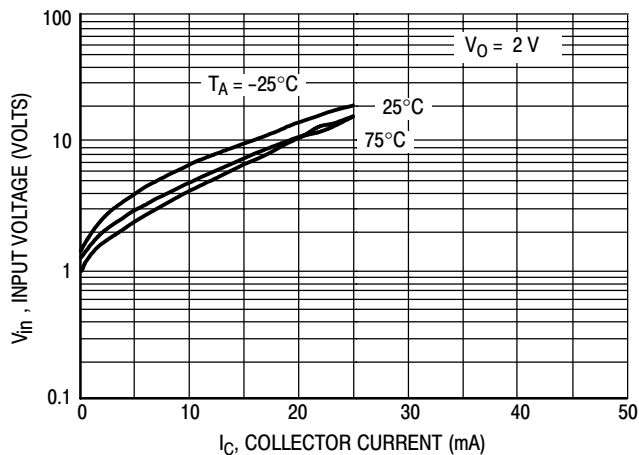

Figure 16. Input Voltage versus Output Current

# MMUN2111LT1 Series

## TYPICAL ELECTRICAL CHARACTERISTICS MMUN2114LT1

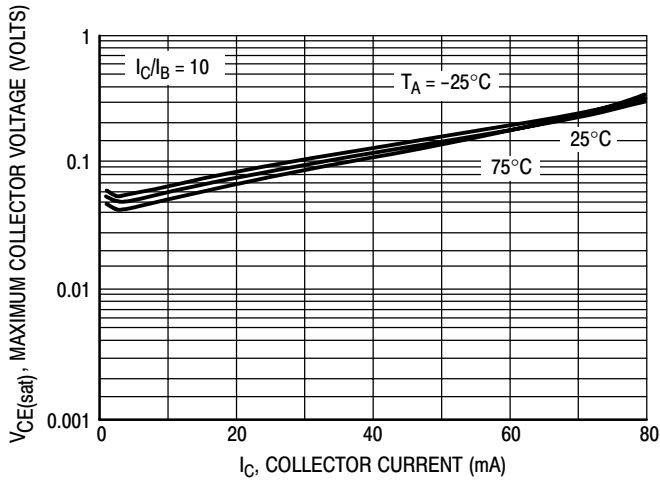

Figure 17.  $V_{CE(sat)}$  versus  $I_C$

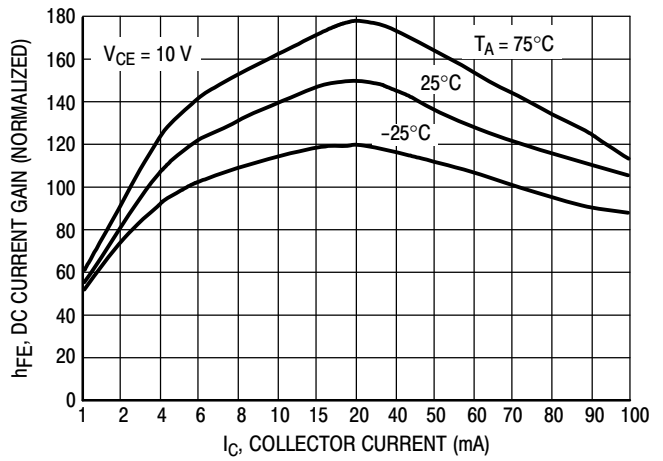

Figure 18. DC Current Gain

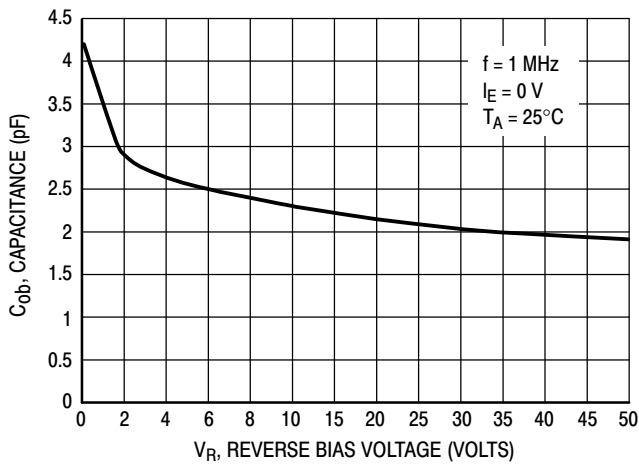

Figure 19. Output Capacitance

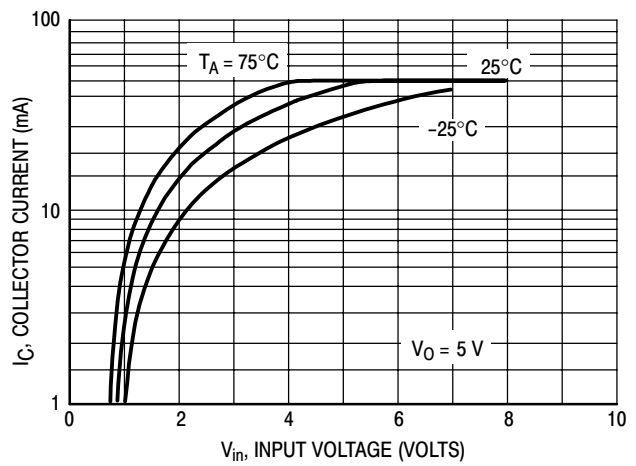

Figure 20. Output Current versus Input Voltage

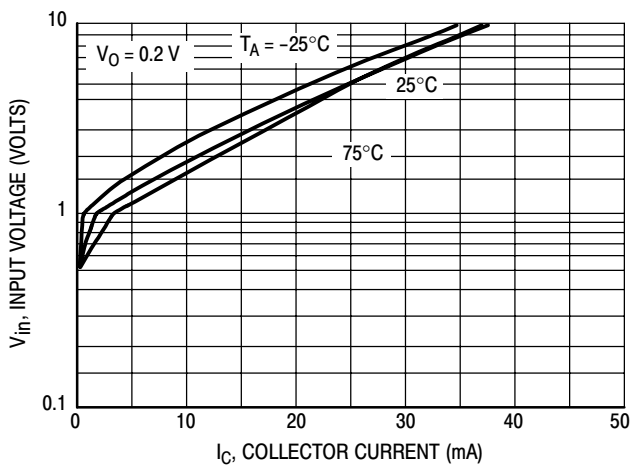

Figure 21. Input Voltage versus Output Current

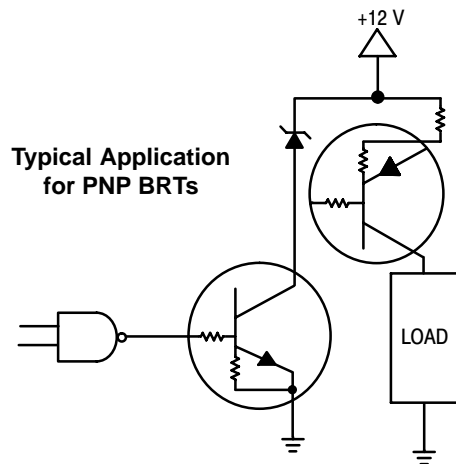
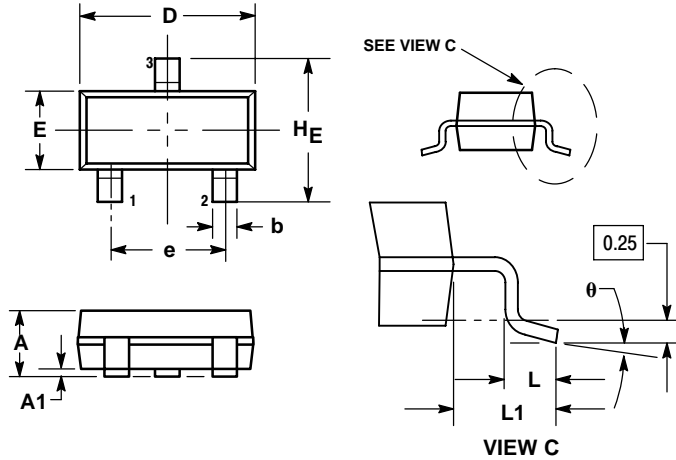

Figure 22. Inexpensive, Unregulated Current Source

# MMUN2111LT1 Series

## PACKAGE DIMENSIONS

SOT-23  
TO-236AB  
CASE 318-08  
ISSUE AM



- NOTES:
1. DIMENSIONING AND TOLERANCING PER ANSI Y14.5M, 1982.
  2. CONTROLLING DIMENSION: INCH.
  3. MAXIMUM LEAD THICKNESS INCLUDES LEAD FINISH THICKNESS. MINIMUM LEAD THICKNESS IS THE MINIMUM THICKNESS OF BASE MATERIAL.
  4. 318-01 THRU -07 AND -09 OBSOLETE, NEW STANDARD 318-08.

DIM	MILLIMETERS			INCHES		
	MIN	NOM	MAX	MIN	NOM	MAX
A	0.89	1.00	1.11	0.035	0.040	0.044
A1	0.01	0.06	0.10	0.001	0.002	0.004
b	0.37	0.44	0.50	0.015	0.018	0.020
c	0.09	0.13	0.18	0.003	0.005	0.007
D	2.80	2.90	3.04	0.110	0.114	0.120
E	1.20	1.30	1.40	0.047	0.051	0.055
e	1.78	1.90	2.04	0.070	0.075	0.081
L	0.10	0.20	0.30	0.004	0.008	0.012
L1	0.35	0.54	0.69	0.014	0.021	0.029
HE	2.10	2.40	2.64	0.083	0.094	0.104

- STYLE 6:  
PIN 1. BASE  
2. EMITTER  
3. COLLECTOR

## SOLDERING FOOTPRINT\*

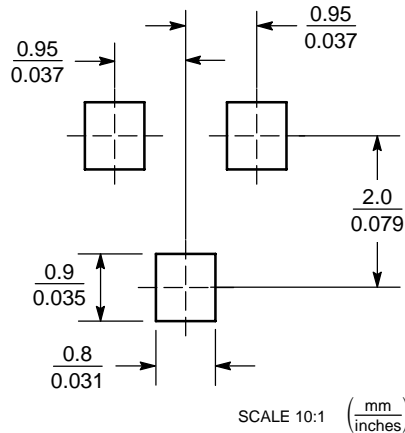

\*For additional information on our Pb-Free strategy and soldering details, please download the ON Semiconductor Soldering and Mounting Techniques Reference Manual, SOLDERRM/D.

ON Semiconductor and are registered trademarks of Semiconductor Components Industries, LLC (SCILLC). SCILLC reserves the right to make changes without further notice to any products herein. SCILLC makes no warranty, representation or guarantee regarding the suitability of its products for any particular purpose, nor does SCILLC assume any liability arising out of the application or use of any product or circuit, and specifically disclaims any and all liability, including without limitation special, consequential or incidental damages. "Typical" parameters which may be provided in SCILLC data sheets and/or specifications can and do vary in different applications and actual performance may vary over time. All operating parameters, including "Typicals" must be validated for each customer application by customer's technical experts. SCILLC does not convey any license under its patent rights nor the rights of others. SCILLC products are not designed, intended, or authorized for use as components in systems intended for surgical implant into the body, or other applications intended to support or sustain life, or for any other application in which the failure of the SCILLC product could create a situation where personal injury or death may occur. Should Buyer purchase or use SCILLC products for any such unintended or unauthorized application, Buyer shall indemnify and hold SCILLC and its officers, employees, subsidiaries, affiliates, and distributors harmless against all claims, costs, damages, and expenses, and reasonable attorney fees arising out of, directly or indirectly, any claim of personal injury or death associated with such unintended or unauthorized use, even if such claim alleges that SCILLC was negligent regarding the design or manufacture of the part. SCILLC is an Equal Opportunity/Affirmative Action Employer. This literature is subject to all applicable copyright laws and is not for resale in any manner.

## PUBLICATION ORDERING INFORMATION

**LITERATURE FULFILLMENT:**  
Literature Distribution Center for ON Semiconductor  
P.O. Box 61312, Phoenix, Arizona 85082-1312 USA  
**Phone:** 480-829-7710 or 800-344-3860 Toll Free USA/Canada  
**Fax:** 480-829-7709 or 800-344-3867 Toll Free USA/Canada  
**Email:** orderlit@onsemi.com

**N. American Technical Support:** 800-282-9855 Toll Free  
USA/Canada

**Japan:** ON Semiconductor, Japan Customer Focus Center  
2-9-1 Kamimeguro, Meguro-ku, Tokyo, Japan 153-0051  
**Phone:** 81-3-5773-3850

**ON Semiconductor Website:** <http://onsemi.com>

**Order Literature:** <http://www.onsemi.com/litorder>

For additional information, please contact your local Sales Representative.