

# NCS1002A

## Constant Voltage / Constant Current Secondary-Side Controller

### Description

The NCS1002A is a performance upgrade from the NCS1002 focused on reducing power consumption in applications that require more efficient operation. It is a highly integrated solution for Switching Mode Power Supply (SMPS) applications requiring a dual control loop to perform Constant Voltage (CV) and Constant Current (CC) regulation. The NCS1002A integrates a 2.5 V voltage reference and two precision op amps. The voltage reference, along with Op Amp 1, is the core of the voltage control-loop. Op Amp 2 is an independent, uncommitted amplifier specifically designed for the current control. Key external components needed to complete the two control loops are: (a) A resistor divider that senses the output of the power supply (battery charger) and fixes the voltage regulation set point at the specified value. (b) A sense resistor that feeds the current sensing circuit with a voltage proportional to the DC output current. This resistor determines the current regulation set point and must be adequately rated in terms of power dissipation. The NCS1002A comes in a small 8-pin SOIC package and is ideal for space-shrunk applications such as battery chargers.

### Features

- Low Input Offset Voltage: 0.5 mV, Typ
- Input Common-Mode Range includes Ground
- Low Quiescent Current: 75  $\mu$ A per Op Amp at  $V_{CC} = 5$  V
- Large Output Voltage Swing
- Wide Power Supply Range: 3 V to 36 V
- High ESD Protection: 2 kV
- This is a Pb-Free Device

### Typical Applications

- Battery Chargers
- Switch Mode Power Supplies



ON Semiconductor®

<http://onsemi.com>

### MARKING DIAGRAMS



- A = Assembly Location
- L = Wafer Lot
- Y = Year
- W = Work Week
- = Pb-Free Package

(Note: Microdot may be in either location)

### PIN CONNECTIONS

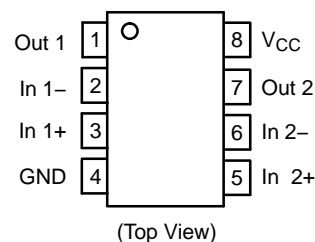

(Top View)

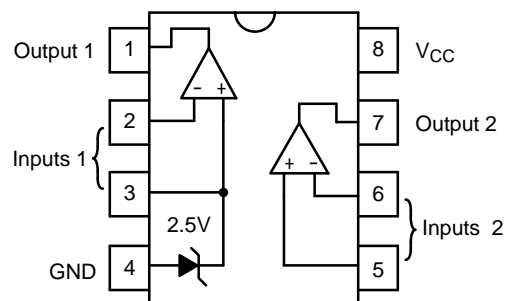

### ORDERING INFORMATION

See detailed ordering and shipping information in the package dimensions section on page 8 of this data sheet.

# NCS1002A

## MAXIMUM RATINGS

Parameter	Symbol	Rating	Unit
Supply Voltage ( $V_{CC}$ to GND) (Operating Range $V_{CC} = 3\text{ V to }36\text{ V}$ )	$V_{CC}$	36	V
Differential Input Voltage	$V_{id}$	36	V
Input Voltage	$V_i$	-0.3 to +36	V
ESD Protection Voltage at Pin Human Body Model	$V_{ESD}$	2000	V
Maximum Junction Temperature	$T_J$	150	°C
Specification Temperature Range ( $T_{min}$ to $T_{max}$ )	$T_A$	-40 to +105	°C
Operating Free-Air Temperature Range	$T_{oper}$	-55 to +125	°C
Storage Temperature Range	$T_{stg}$	-55 to +150	°C

Stresses exceeding Maximum Ratings may damage the device. Maximum Ratings are stress ratings only. Functional operation above the Recommended Operating Conditions is not implied. Extended exposure to stresses above the Recommended Operating Conditions may affect device reliability.

## THERMAL CHARACTERISTICS

Parameter	Symbol	Rating	Unit
Thermal Resistance Junction-to-Ambient	$R_{\theta JA}$	175	°C/W

# NCS1002A

## ELECTRICAL CHARACTERISTICS

Symbol	Characteristics	Conditions	Min	Typ	Max	Unit
I <sub>CC</sub>	Total Supply Current, excluding current in the Voltage Reference V <sub>CC</sub> = 5 V, no load; -40 ≤ T <sub>A</sub> ≤ +105°C			0.15	0.25	mA
I <sub>CC</sub>	Total Supply Current, excluding Current in the Voltage Reference V <sub>CC</sub> = 30 V, no load; -40 ≤ T <sub>A</sub> ≤ +105°C			0.2	0.3	mA

### OP AMP 1 (OP AMP WITH NONINVERTING INPUT CONNECTED TO THE INTERNAL V<sub>ref</sub>)

(V<sub>CC</sub> = 5 V, T<sub>A</sub> = 25°C unless otherwise noted)

V <sub>IO</sub>	Input Offset Voltage	T <sub>A</sub> = 25°C			2.0	mV
		-40 ≤ T <sub>A</sub> ≤ +105°C			3.0	mV
DV <sub>IO</sub>	Input Offset Voltage Drift (-40 ≤ T <sub>A</sub> ≤ +105°C)			7.0		μV/°C
I <sub>B</sub>	Input Bias Current (Inverting Input Only)			20	150	nA
AVD	Large Signal Voltage Gain (V <sub>CC</sub> = 15 V, R <sub>L</sub> = 2 kΩ, V <sub>ICM</sub> = 0 V)			100		V/mV
PSRR	Power Supply Rejection (V <sub>CC</sub> = 5.0 V to 30 V, V <sub>OUT</sub> = 2 V)		80	100		dB
I <sub>SOURCE</sub>	Output Source Current (V <sub>CC</sub> = 15 V, V <sub>OUT</sub> = 2.0 V, V <sub>id</sub> = 1 V)		20	40		mA
I <sub>O</sub>	Short Circuit to GND (V <sub>CC</sub> = 15 V)			40	60	mA
I <sub>SINK</sub>	Output Current Sink (V <sub>id</sub> = -1 V)	V <sub>CC</sub> = +15 V, V <sub>OUT</sub> = 0.2 V (Note 1)	1	10		mA
		V <sub>CC</sub> = +15 V, V <sub>OUT</sub> = 2 V	10	20		mA
V <sub>OH</sub>	Output Voltage Swing, High (V <sub>CC</sub> = 30 V)	R <sub>L</sub> = 2 kΩ, T <sub>A</sub> = 25°C	26	27		V
		-40 ≤ T <sub>A</sub> ≤ +105°C	26			
		R <sub>L</sub> = 10 kΩ, T <sub>A</sub> = 25°C	27	28		
		-40 ≤ T <sub>A</sub> ≤ +105°C	27			
V <sub>OL</sub>	Output Voltage Swing, Low	R <sub>L</sub> = 10 kΩ, T <sub>A</sub> = 25°C		5.0	50	mV
SR	Slew Rate (AV = +1, V <sub>i</sub> = 0.5 V to 2 V, V <sub>CC</sub> = 15 V, R <sub>L</sub> = 2 kΩ, C <sub>L</sub> = 100 pF)		0.2	0.4		V/μs
GBP	Gain Bandwidth Product (V <sub>CC</sub> = 30 V, AV = +1, (Note 1) R <sub>L</sub> = 2 kΩ, C <sub>L</sub> = 100 pF, f = 100 kHz, V <sub>IN</sub> = 10 mV <sub>PP</sub> )		0.5	0.9		MHz
THD	Total Harmonic Distortion (f = 1 kHz, AV = 10, R <sub>L</sub> = 2 kΩ, V <sub>CC</sub> = 30 V, V <sub>OUT</sub> = 2 V <sub>PP</sub> )			0.08		%

### OP AMP 2 (INDEPENDENT OP AMP) (V<sub>CC</sub> = 5.0 V, T<sub>A</sub> = 25°C unless otherwise noted)

V <sub>IO</sub>	Input Offset Voltage	T <sub>A</sub> = 25°C		0.5	2.0	mV
		-40 ≤ T <sub>A</sub> ≤ +105°C			3.0	
DV <sub>IO</sub>	Input Offset Voltage Drift (-40 ≤ T <sub>A</sub> ≤ +105°C)			7.0		μV/°C
I <sub>IO</sub>	Input Offset Current	T <sub>A</sub> = 25°C		2.0	75	nA
		-40 ≤ T <sub>A</sub> ≤ +105°C			150	
I <sub>B</sub>	Input Bias Current	T <sub>A</sub> = 25°C		20	150	nA
		-40 ≤ T <sub>A</sub> ≤ +105°C			200	
AVD	Large Signal Voltage Gain (V <sub>CC</sub> = 15 V, R <sub>L</sub> = 2 kΩ, V <sub>OUT</sub> = 1.4 V to 11.4 V)	T <sub>A</sub> = 25°C	50	100		V/mV
		-40 ≤ T <sub>A</sub> ≤ +105°C	25			
PSRR	Power Supply Rejection (V <sub>CC</sub> = 5 V to 30 V)		80	100		dB

1. Guaranteed by design and/or characterization.

# NCS1002A

## ELECTRICAL CHARACTERISTICS (continued)

Symbol	Characteristics	Conditions	Min	Typ	Max	Unit
<b>OP AMP 2 (INDEPENDENT OP AMP) (continued)</b> ( $V_{CC} = 5.0\text{ V}$ , $T_A = 25^\circ\text{C}$ unless otherwise noted)						
$V_{ICM}$	Input Common Mode Voltage Range (Note 2) ( $V_{CC} = +30\text{ V}$ )	$T_A = 25^\circ\text{C}$	0		$V_{CC} - 1.5$	V
		$-40 \leq T_A \leq +105^\circ\text{C}$	0		$V_{CC} - 2.0$	
CMRR	Common Mode Rejection Ratio (Note 4)	0 to $V_{CC} - 1.7\text{ V}$ , $T_A = 25^\circ\text{C}$	70	85		dB
		0 to $V_{CC} - 2.2\text{ V}$ $-40 \leq T_A \leq +105^\circ\text{C}$	60			
$I_{SOURCE}$	Output Current Source ( $V_{CC} = 15\text{ V}$ , $V_{OUT} = 2\text{ V}$ , $V_{ID} = +1\text{ V}$ )		20	40		mA
$I_O$	Short-Circuit to GND ( $V_{CC} = 15\text{ V}$ )			40	60	mA
$I_{SINK}$	Output Current Sink ( $V_{ID} = -1\text{ V}$ )	$V_{CC} = +15\text{ V}$ , $V_{OUT} = 0.2\text{ V}$	1	10		mA
		$V_{CC} = +15\text{ V}$ , $V_{OUT} = 2\text{ V}$	10	20		mA
$V_{OH}$	Output Voltage Swing, High ( $V_{CC} = 30\text{ V}$ )	$R_L = 2\text{ k}\Omega$ , $T_A = 25^\circ\text{C}$	26	27		V
		$-40 \leq T_A \leq +105^\circ\text{C}$	26			
		$R_L = 10\text{ k}\Omega$ , $T_A = 25^\circ\text{C}$	27	28		
		$-40 \leq T_A \leq +105^\circ\text{C}$	27			
$V_{OL}$	Output Voltage Swing, Low	$R_L = 10\text{ k}\Omega$ , $T_A = 25^\circ\text{C}$		5.0	50	mV
SR	Slew Rate ( $AV = +1$ , $V_i = 0.5\text{ V}$ to $3\text{ V}$ , $V_{CC} = 15\text{ V}$ , $R_L = 2\text{ k}\Omega$ , $C_L = 100\text{ pF}$ )		0.2	0.4		$\text{V}/\mu\text{s}$
GBP	Gain Bandwidth Product ( $V_{CC} = 30\text{ V}$ , $AV = +1$ , $R_L = 2\text{ k}\Omega$ , $C_L = 100\text{ pF}$ , $f = 100\text{ kHz}$ , $V_{IN} = 10\text{ mV}_{PP}$ ) (Note 4)		0.5	0.9		MHz
THD	Total Harmonic Distortion ( $f = 1\text{ kHz}$ , $AV = 10$ , $R_L = 2\text{ k}\Omega$ , $V_{CC} = 30\text{ V}$ , $V_{OUT} = 2\text{ V}_{PP}$ )			0.08		%
$e_{noise}$	Equivalent Input Noise Voltage ( $f = 1\text{ kHz}$ , $R_S = 100\ \Omega$ , $V_{CC} = 30\text{ V}$ )			50		$\text{nV}/\sqrt{\text{Hz}}$

## VOLTAGE REFERENCE ( $V_{CC} = 5.0\text{ V}$ , $T_A = 25^\circ\text{C}$ unless otherwise noted)

$I_K$	Cathode Current		0.05		100	mA
$V_{ref}$	Reference Voltage ( $I_K = 1\text{ mA}$ )	$T_A = 25^\circ\text{C}$	2.49	2.5	2.51	V
		$-40 \leq T_A \leq +105^\circ\text{C}$	2.48	2.5	2.52	
$\Delta V_{ref}$	Reference Deviation over Temperature ( $V_{KA} = V_{ref}$ , $I_K = 10\text{ mA}$ , $-40 \leq T_A \leq +105^\circ\text{C}$ ) (Note 4)			7.0	30	mV
$I_{min}$	Minimum Cathode Current for Regulation ( $2.4875\text{ V}_f \leq V_{KA} \leq 2.5125\text{ V}_f$ )			10	50	$\mu\text{A}$
$ Z_{KA} $	Dynamic Impedance (Note 3) ( $V_{KA} = V_{ref}$ , $I_K = 1\text{ mA}$ to $100\text{ mA}$ , $f < 1\text{ kHz}$ )			0.2	0.5	$\Omega$

- The input common-mode voltage of either input signal should not be allowed to go negative by more than 0.3 V. The upper end of the common-mode range is  $V_{CC} - 1.5\text{ V}$ . Both inputs can go to  $V_{CC} + 0.3\text{ V}$  without damage.
- The Dynamic Impedance is defined as  $|Z_{KA}| = \Delta V_{KA} / \Delta I_K$ .
- Guaranteed by design and/or characterization.

# NCS1002A

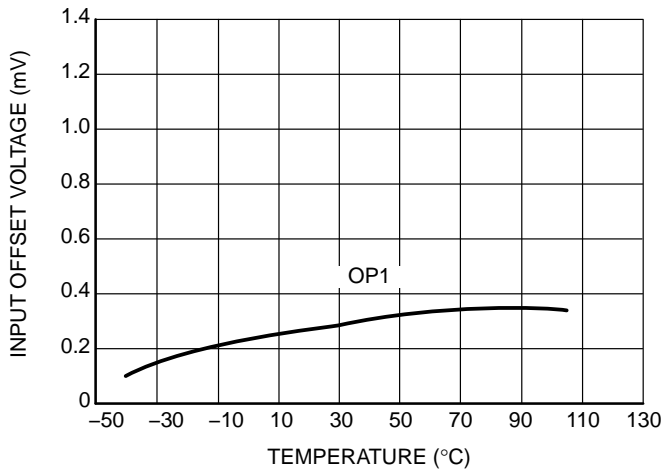

Figure 1. Input Offset Voltage vs. Temperature

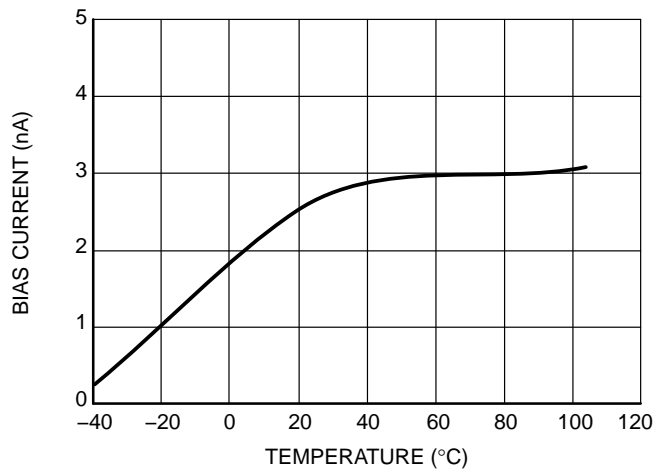

Figure 2. IB vs. Temperature

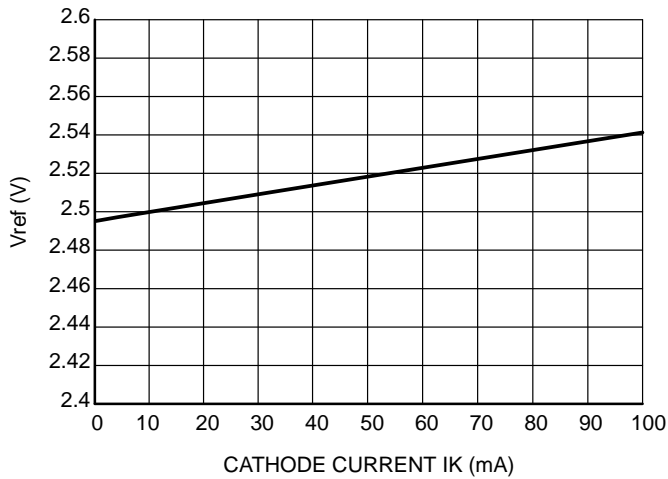

Figure 3. Vref as a Function of IK

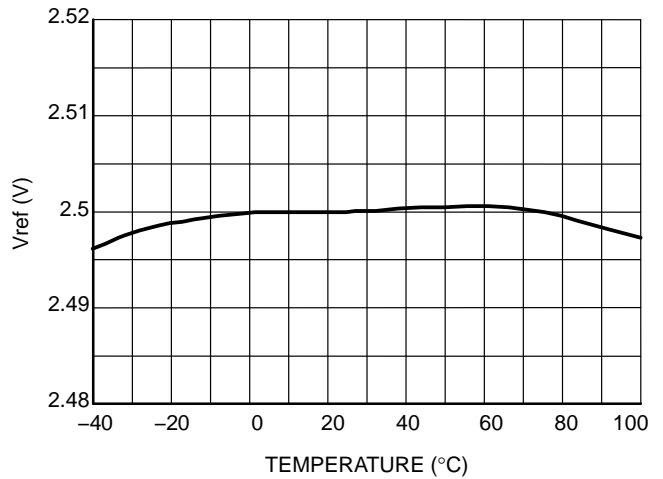

Figure 4. Vref Over Temperature

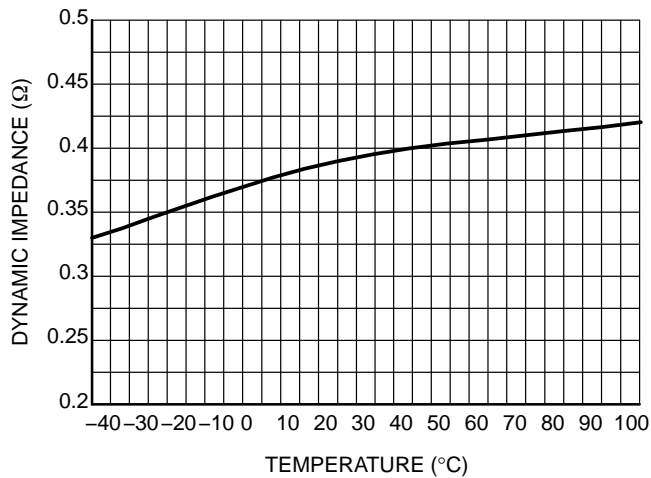

Figure 5. Ref Dynamic Impedance vs. Temperature

# NCS1002A

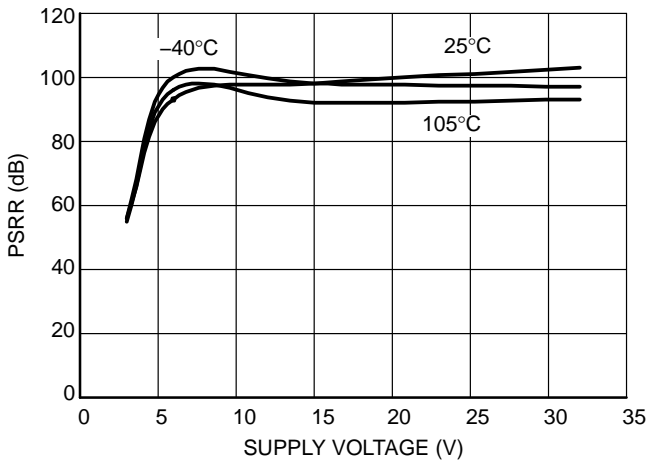

Figure 6. NCS1002A PSRR vs. Supply Voltage

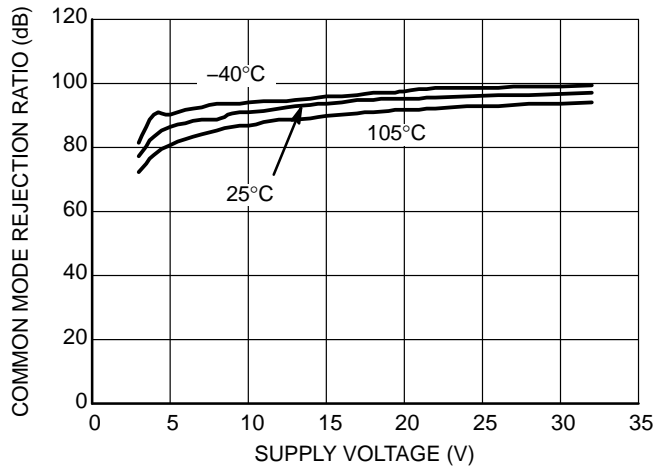

Figure 7. NCS1002A CMRR vs. Supply Voltage

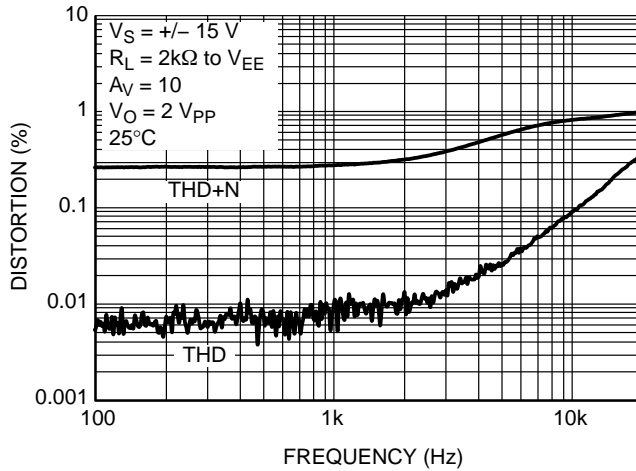

Figure 8. Distortion vs. Frequency

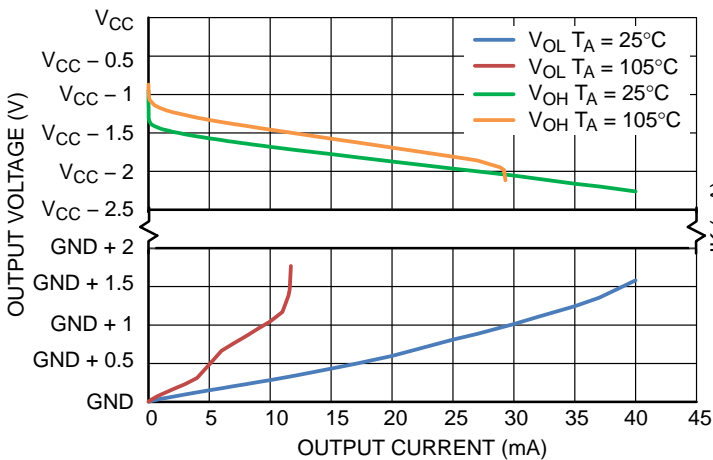

Figure 9. Output Voltage Swing vs. Output Current  
 $V_{id} = 1\text{ V}$ ,  $V_{CM} = 0\text{ V}$ ,  $V_{CC} = 3\text{ V to }36\text{ V}$

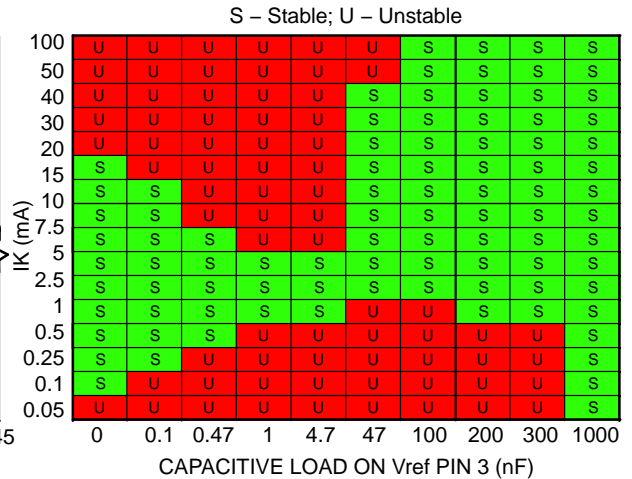

Figure 10. Region of Reference Stability vs. Capacitive Load (Pin 3)

# NCS1002A

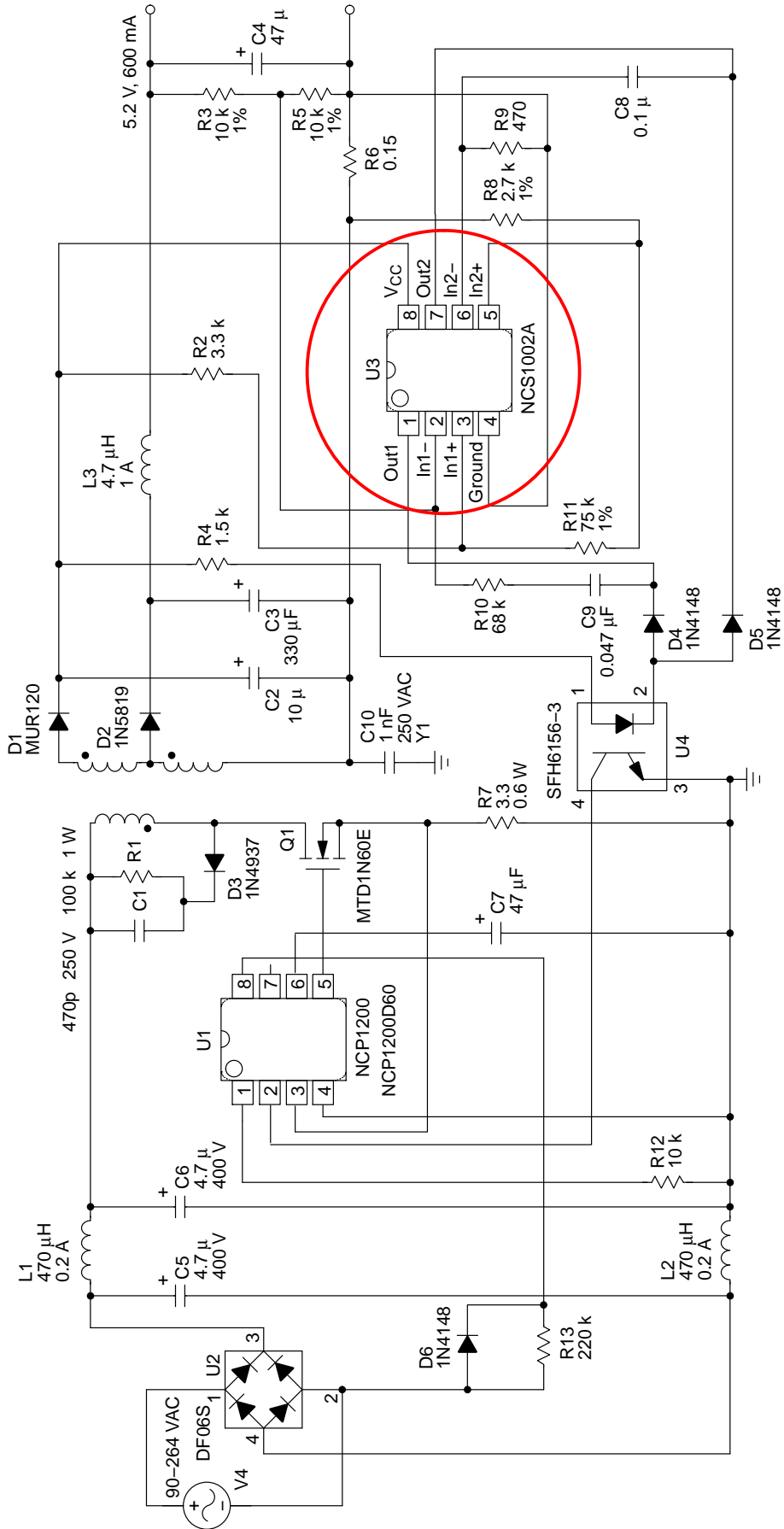

Figure 1. AC Adapter Application

# NCS1002A

## ORDERING INFORMATION

Device	Package	Shipping†
NCS1002ADR2G	SOIC-8 (Pb-Free)	2500 / Tape & Reel

†For information on tape and reel specifications, including part orientation and tape sizes, please refer to our Tape and Reel Packaging Specifications Brochure, BRD8011/D.



# NCS1002A

## PACKAGE DIMENSIONS

SOIC-8 NB  
CASE 751-07  
ISSUE AK

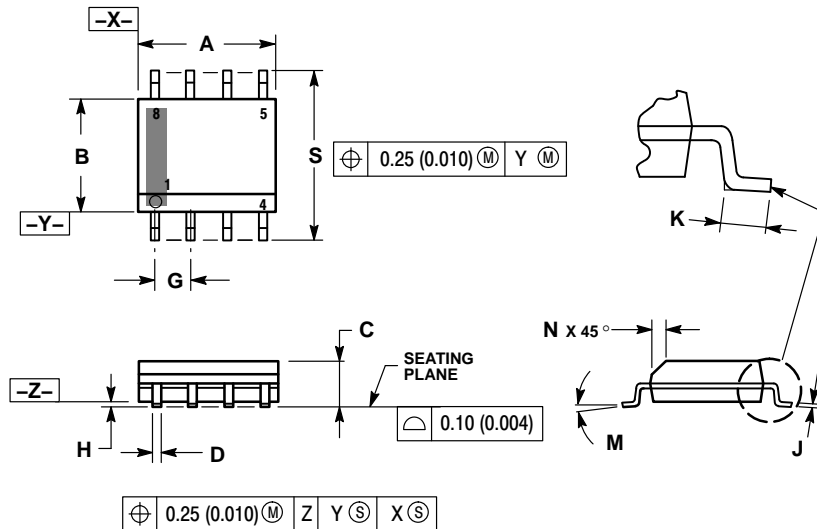

### NOTES:

1. DIMENSIONING AND TOLERANCING PER ANSI Y14.5M, 1982.
2. CONTROLLING DIMENSION: MILLIMETER.
3. DIMENSION A AND B DO NOT INCLUDE MOLD PROTRUSION.
4. MAXIMUM MOLD PROTRUSION 0.15 (0.006) PER SIDE.
5. DIMENSION D DOES NOT INCLUDE DAMBAR PROTRUSION. ALLOWABLE DAMBAR PROTRUSION SHALL BE 0.127 (0.005) TOTAL IN EXCESS OF THE D DIMENSION AT MAXIMUM MATERIAL CONDITION.
6. 751-01 THRU 751-06 ARE OBSOLETE. NEW STANDARD IS 751-07.

DIM	MILLIMETERS		INCHES	
	MIN	MAX	MIN	MAX
A	4.80	5.00	0.189	0.197
B	3.80	4.00	0.150	0.157
C	1.35	1.75	0.053	0.069
D	0.33	0.51	0.013	0.020
G	1.27 BSC		0.050 BSC	
H	0.10	0.25	0.004	0.010
J	0.19	0.25	0.007	0.010
K	0.40	1.27	0.016	0.050
M	0°	8°	0°	8°
N	0.25	0.50	0.010	0.020
S	5.80	6.20	0.228	0.244

### SOLDERING FOOTPRINT\*

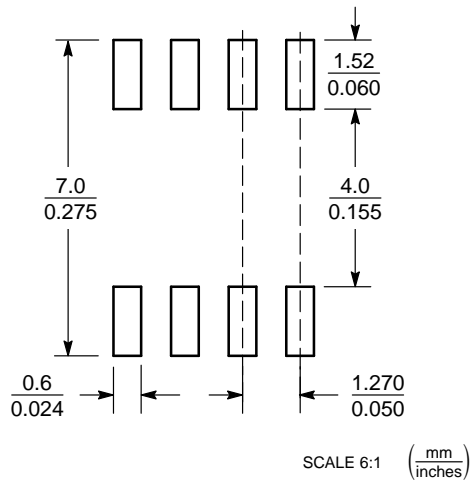

\*For additional information on our Pb-Free strategy and soldering details, please download the ON Semiconductor Soldering and Mounting Techniques Reference Manual, SOLDERRM/D.

ON Semiconductor and are registered trademarks of Semiconductor Components Industries, LLC (SCILLC). SCILLC owns the rights to a number of patents, trademarks, copyrights, trade secrets, and other intellectual property. A listing of SCILLC's product/patent coverage may be accessed at [www.onsemi.com/site/pdf/Patent-Marking.pdf](http://www.onsemi.com/site/pdf/Patent-Marking.pdf). SCILLC reserves the right to make changes without further notice to any products herein. SCILLC makes no warranty, representation or guarantee regarding the suitability of its products for any particular purpose, nor does SCILLC assume any liability arising out of the application or use of any product or circuit, and specifically disclaims any and all liability, including without limitation special, consequential or incidental damages. "Typical" parameters which may be provided in SCILLC data sheets and/or specifications can and do vary in different applications and actual performance may vary over time. All operating parameters, including "Typicals" must be validated for each customer application by customer's technical experts. SCILLC does not convey any license under its patent rights nor the rights of others. SCILLC products are not designed, intended, or authorized for use as components in systems intended for surgical implant into the body, or other applications intended to support or sustain life, or for any other application in which the failure of the SCILLC product could create a situation where personal injury or death may occur. Should Buyer purchase or use SCILLC products for any such unintended or unauthorized application, Buyer shall indemnify and hold SCILLC and its officers, employees, subsidiaries, affiliates, and distributors harmless against all claims, costs, damages, and expenses, and reasonable attorney fees arising out of, directly or indirectly, any claim of personal injury or death associated with such unintended or unauthorized use, even if such claim alleges that SCILLC was negligent regarding the design or manufacture of the part. SCILLC is an Equal Opportunity/Affirmative Action Employer. This literature is subject to all applicable copyright laws and is not for resale in any manner.

### PUBLICATION ORDERING INFORMATION

**LITERATURE FULFILLMENT:**  
Literature Distribution Center for ON Semiconductor  
P.O. Box 5163, Denver, Colorado 80217 USA  
Phone: 303-675-2175 or 800-344-3860 Toll Free USA/Canada  
Fax: 303-675-2176 or 800-344-3867 Toll Free USA/Canada  
Email: [orderlit@onsemi.com](mailto:orderlit@onsemi.com)

**N. American Technical Support:** 800-282-9855 Toll Free  
USA/Canada  
**Europe, Middle East and Africa Technical Support:**  
Phone: 421 33 790 2910  
**Japan Customer Focus Center**  
Phone: 81-3-5817-1050

**ON Semiconductor Website:** [www.onsemi.com](http://www.onsemi.com)  
**Order Literature:** <http://www.onsemi.com/orderlit>

For additional information, please contact your local Sales Representative