



FFSH15120A

Silicon Carbide Schottky Diode

1200 V, 15 A

Features

- Max Junction Temperature 175 °C
- Avalanche Rated 145 mJ
- High Surge Current Capacity
- Positive Temperature Coefficient
- Ease of Paralleling
- No Reverse Recovery / No Forward Recovery

Applications

- General Purpose
- SMPS, Solar Inverter, UPS
- Power Switching Circuits

Description

Silicon Carbide (SiC) Schottky Diodes use a completely new technology that provides superior switching performance and higher reliability compared to Silicon. No reverse recovery current, temperature independent switching characteristics, and excellent thermal performance sets Silicon Carbide as the next generation of power semiconductor. System benefits include highest efficiency, faster operating frequency, increased power density, reduced EMI, and reduced system size & cost.

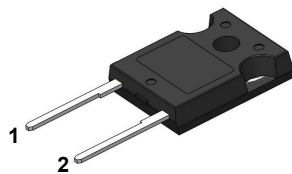

TO-247-2L

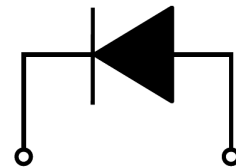

1. Cathode

2. Anode

Absolute Maximum Ratings $T_C = 25\text{ }^\circ\text{C}$ unless otherwise noted.

Symbol	Parameter	FFSH15120A	Unit	
V_{RRM}	Peak Repetitive Reverse Voltage	1200	V	
E_{AS}	Single Pulse Avalanche Energy (Note 1)	145	mJ	
I_F	Continuous Rectified Forward Current @ $T_C < 159\text{ }^\circ\text{C}$	15	A	
	Continuous Rectified Forward Current @ $T_C < 135\text{ }^\circ\text{C}$	26	A	
$I_{F, Max}$	Non-Repetitive Peak Forward Surge Current	$T_C = 25\text{ }^\circ\text{C}$, 10 μs	920	A
		$T_C = 150\text{ }^\circ\text{C}$, 10 μs	870	A
$I_{F, SM}$	Non-Repetitive Forward Surge Current	Half-Sine Pulse, $t_p = 8.3\text{ ms}$	115	A
$I_{F, RM}$	Repetitive Forward Surge Current	Half-Sine Pulse, $t_p = 8.3\text{ ms}$	50	A
P_{tot}	Power Dissipation	$T_C = 25\text{ }^\circ\text{C}$	283	W
		$T_C = 150\text{ }^\circ\text{C}$	47	W
T_J, T_{STG}	Operating and Storage Temperature Range	-55 to +175	$^\circ\text{C}$	

Thermal Characteristic

Symbol	Parameter	FFSH15120A	Unit
$R_{\theta JC}$	Thermal Resistance, Junction to Case, Max	0.53	$^\circ\text{C/W}$

Package Marking and Ordering Information

Part Number	Top Mark	Package	Packing Method	Reel Size	Tape Width	Quantity
FFSH15120A	FFSH15120A	TO-247-2L	Tube	N/A	N/A	30 units

Electrical Characteristics $T_C = 25\text{ }^\circ\text{C}$ unless otherwise noted.

Symbol	Parameter	Test Conditions	Min.	Typ.	Max.	Unit
V_F	Forward Voltage	$I_F = 15\text{ A}, T_C = 25\text{ }^\circ\text{C}$	-	1.45	1.75	V
		$I_F = 15\text{ A}, T_C = 125\text{ }^\circ\text{C}$	-	1.7	2	
		$I_F = 15\text{ A}, T_C = 175\text{ }^\circ\text{C}$	-	2	2.4	
I_R	Reverse Current	$V_R = 1200\text{ V}, T_C = 25\text{ }^\circ\text{C}$	-	-	200	μA
		$V_R = 1200\text{ V}, T_C = 125\text{ }^\circ\text{C}$	-	-	300	
		$V_R = 1200\text{ V}, T_C = 175\text{ }^\circ\text{C}$	-	-	400	
Q_C	Total Capacitive Charge	$V = 800\text{ V}$	-	95	-	nC
C	Total Capacitance	$V_R = 1\text{ V}, f = 100\text{ kHz}$	-	936	-	pF
		$V_R = 400\text{ V}, f = 100\text{ kHz}$	-	86	-	
		$V_R = 800\text{ V}, f = 100\text{ kHz}$	-	68	-	

Notes:

1: EAS of 145 mJ is based on starting $T_J = 25\text{ }^\circ\text{C}$, $L = 0.5\text{ mH}$, $I_{AS} = 24\text{ A}$, $V = 50\text{ V}$.

Typical Characteristics $T_J = 25\text{ }^\circ\text{C}$ unless otherwise noted.

Figure 1. Forward Characteristics

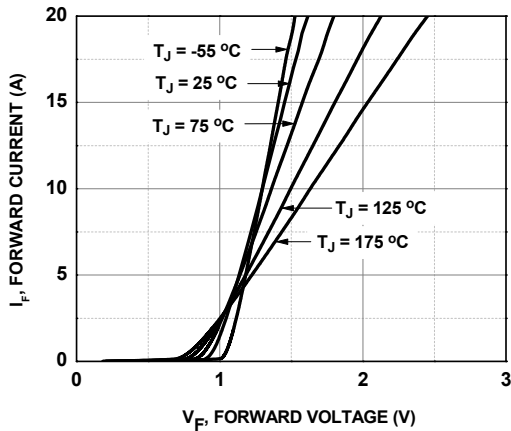

Figure 2. Reverse Characteristics

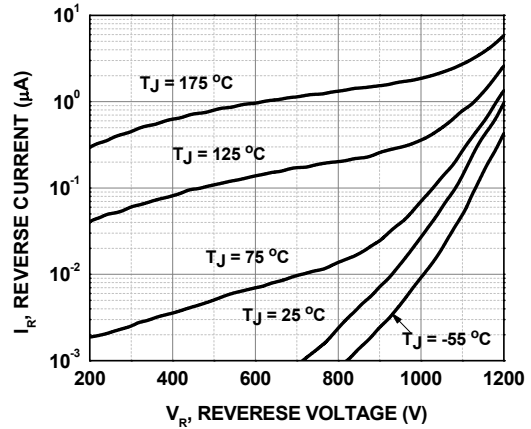

Figure 3. Reverse Characteristics

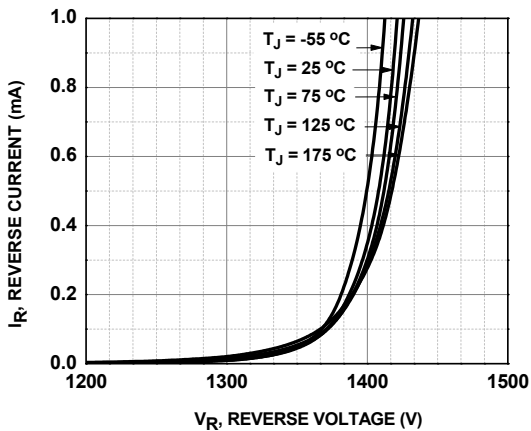
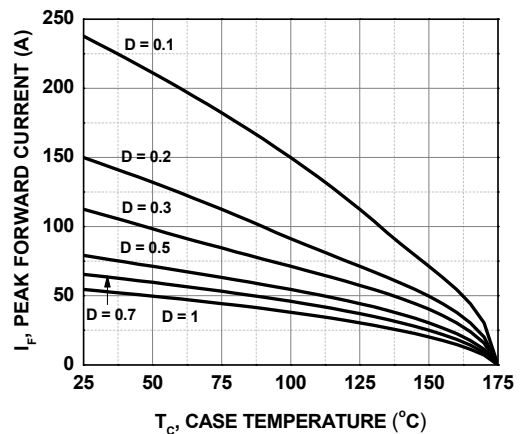

Figure 4. Current Derating



Typical Characteristics $T_J = 25^\circ\text{C}$ unless otherwise noted.

Figure 5. Power Derating

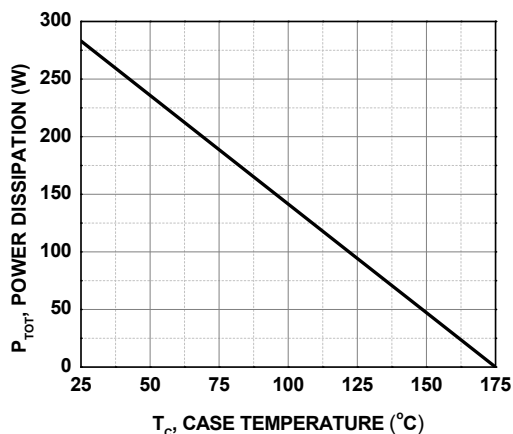

Figure 6. Capacitive Charge vs. Reverse Voltage

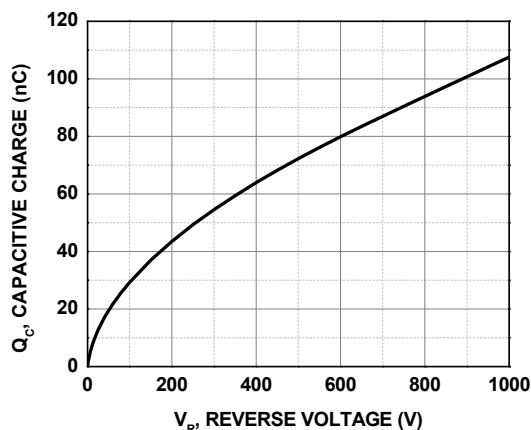

Figure 7. Capacitance vs. Reverse Voltage

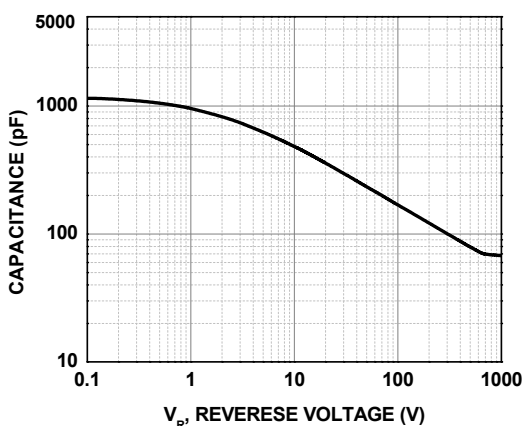

Figure 8. Capacitance Stored Energy

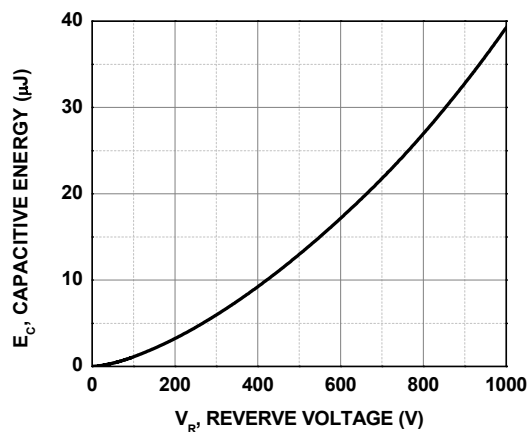
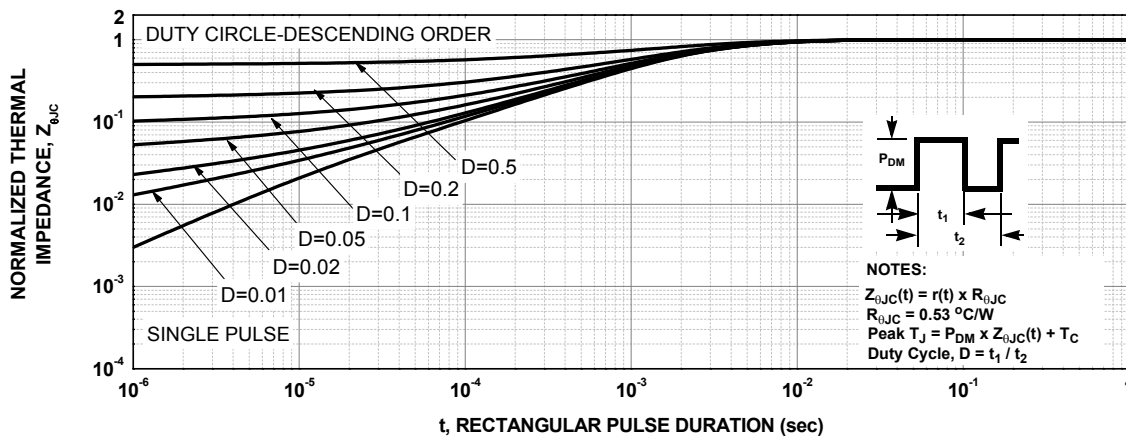

Figure 9. Junction-to-Case Transient Thermal Response Curve



Test Circuit and Waveforms

Figure 10. Unclamped Inductive Switching Test Circuit & Waveform

$L = 0.5\text{mH}$

$R < 0.1\Omega$

$V_{DD} = 50\text{V}$

$E_{AVL} = 1/2 L I^2 [V_{R(AVL)} / (V_{R(AVL)} - V_{DD})]$

$Q1 = \text{IGBT (} BV_{CES} > DUT V_{R(AVL)} \text{)}$

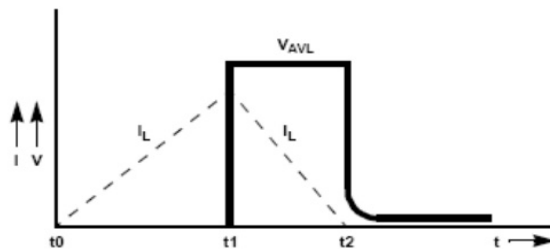
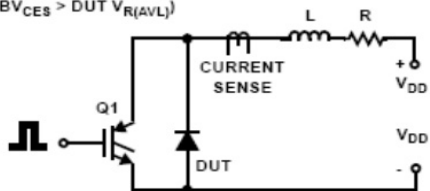

Mechanical Dimensions

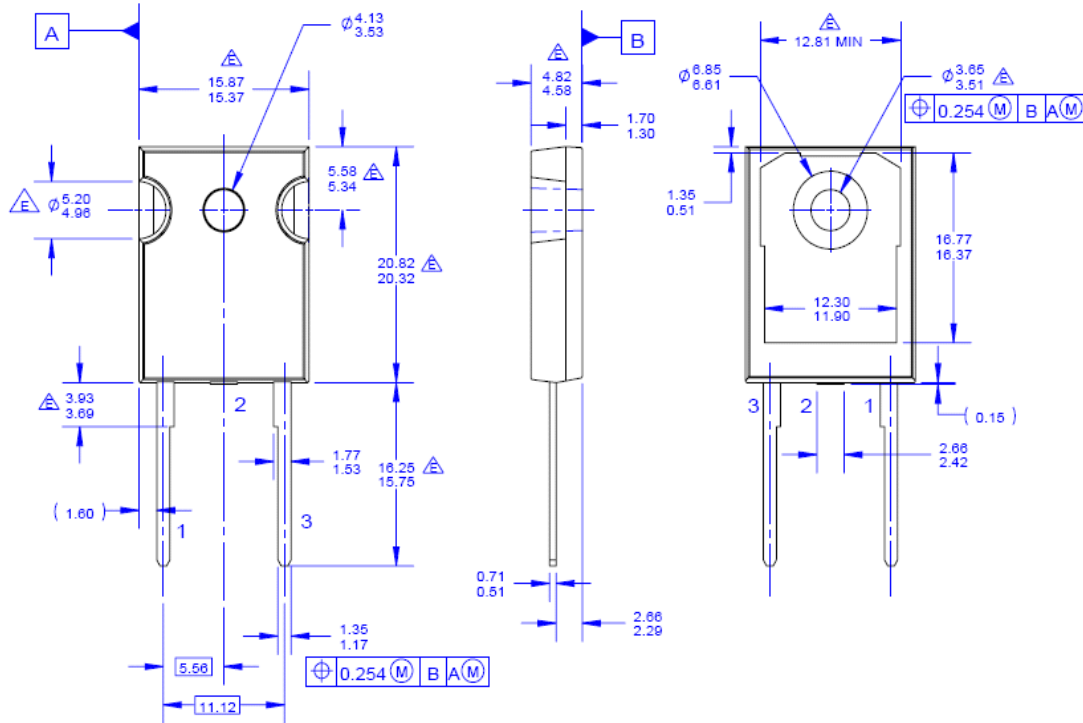

NOTES: UNLESS OTHERWISE SPECIFIED.

- A. PACKAGE REFERENCE: JEDEC TO-247, ISSUE E, VARIATION AB, DATED JUNE, 2004.
- B. DIMENSIONS ARE EXCLUSIVE OF BURRS, MOLD FLASH, AND TIE BAR EXTRUSIONS.
- C. ALL DIMENSIONS ARE IN MILLIMETERS.
- D. DRAWING CONFORMS TO ASME Y14.5 - 2009.
- E. DOES NOT COMPLY JEDEC STANDARD VALUE.
- F. DRAWING FILENAME: MKT-TO247B02_REV04.
- G. FAIRCHILD SEMICONDUCTOR.

Figure 11. TO-247, Molded, 2LD, Jedec Option AB

ON Semiconductor and the ON Logo are trademarks of Semiconductor Components Industries, LLC dba ON Semiconductor or its subsidiaries in the United States and/or other countries. ON Semiconductor owns the rights to a number of patents, trademarks, copyrights, trade secrets, and other intellectual property. A listing of ON Semiconductor's product/patent coverage may be accessed at www.onsemi.com/site/pdf/Patent-Marking.pdf. ON Semiconductor reserves the right to make changes without further notice to any products herein. ON Semiconductor makes no warranty, representation or guarantee regarding the suitability of its products for any particular purpose, nor does ON Semiconductor assume any liability arising out of the application or use of any product or circuit, and specifically disclaims any and all liability, including without limitation special, consequential or incidental damages. Buyer is responsible for its products and applications using ON Semiconductor products, including compliance with all laws, regulations and safety requirements or standards, regardless of any support or applications information provided by

ON Semiconductor. "Typical" parameters which may be provided in ON Semiconductor data sheets and/or specifications can and do vary in different applications and actual performance may vary over time. All operating parameters, including "Typicals" must be validated for each customer application by customer's technical experts. ON Semiconductor does not convey any license under its patent rights nor the rights of others. ON Semiconductor products are not designed, intended, or authorized for use as a critical component in life support systems or any FDA Class 3 medical devices or medical devices with a same or similar classification in a foreign jurisdiction or any devices intended for implantation in the human body. Should Buyer purchase or use ON Semiconductor products for any such unintended or unauthorized application, Buyer shall indemnify and hold ON Semiconductor and its officers, employees, subsidiaries, affiliates, and distributors harmless against all claims, costs, damages, and expenses, and reasonable attorney fees arising out of, directly or indirectly, any claim of personal injury or death associated with such unintended or unauthorized use, even if such claim alleges that ON Semiconductor was negligent regarding the design or manufacture of the part. ON Semiconductor is an Equal Opportunity/Affirmative Action Employer. This literature is subject to all applicable copyright laws and is not for resale in any manner.