

# LDO Regulator, 100 mA, 18 V, 1 $\mu$ A $I_Q$ , with PG

## NCV8711

The NCV8711 device is based on unique combination of features – very low quiescent current, fast transient response and high input and output voltage ranges. The NCV8711 is CMOS LDO regulator designed for up to 18 V input voltage and 100 mA output current. Quiescent current of only 1  $\mu$ A makes this device ideal solution for battery– powered, always–on systems. Several fixed output voltage versions are available as well as the adjustable version.

The device (version B) implements power good circuit (PG) which indicates that output voltage is in regulation. This signal could be used for power sequencing or as a microcontroller reset.

Internal short circuit and over temperature protections saves the device against overload conditions.

### Features

- Operating Input Voltage Range: 2.7 V to 18 V
- Output Voltage: 1.2 V to 17 V
- Capable of Sourcing 140 mA Peak Output Current
- Very Low Quiescent Current: 1  $\mu$ A typ.
- Low Dropout: 215 mV typ. at 100 mA
- Output Voltage Accuracy  $\pm$ 1%
- Power Good Output (Version B)
- Stable with Small 1  $\mu$ F Ceramic Capacitors
- Built–in Soft Start Circuit to Suppress Inrush Current
- Over–Current and Thermal Shutdown Protections
- Available in Small TSOP–5 and WDFNW6 (2x2) Packages
- These Devices are Pb–Free and are RoHS Compliant

### Typical Applications

- Body Control Modules
- LED Lighting
- On Board Charger
- General Purpose Automotive



**ON Semiconductor®**

[www.onsemi.com](http://www.onsemi.com)



TSOP–5  
CASE 483



WDFNW6 (2x2)  
CASE 511DW

### MARKING DIAGRAMS

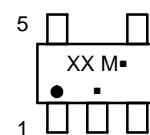

XX = Specific Device Code

M = Date Code

▪ = Pb–Free Package

(Note: Microdot may be in either location)

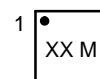

XX = Specific Device Code

M = Date Code

### PIN ASSIGNMENTS

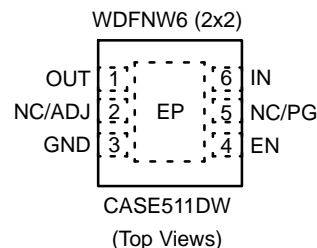
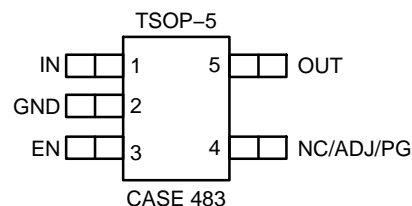

### ORDERING INFORMATION

See detailed ordering and shipping information on page 9 of this data sheet.

# NCV8711

## TYPICAL APPLICATION SCHEMATICS

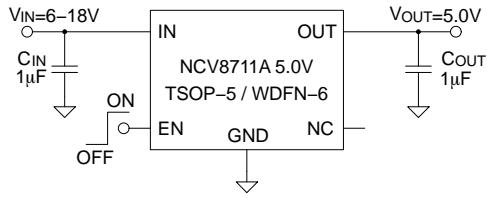

Figure 1. Fixed Output Voltage Application (No PG)

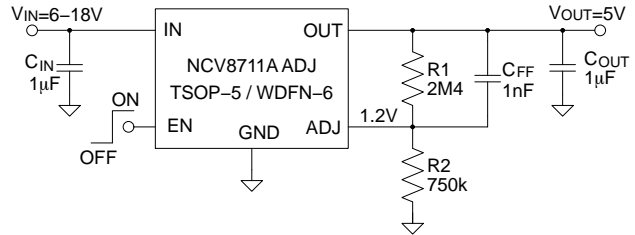

Figure 2. Adjustable Output Voltage Application (No PG)

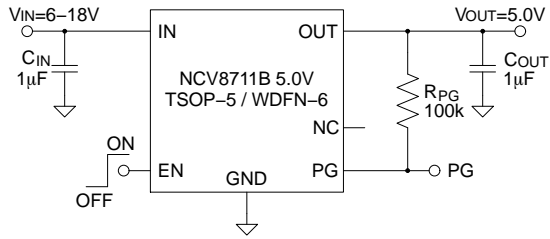

Figure 3. Fixed Output Voltage Application with PG

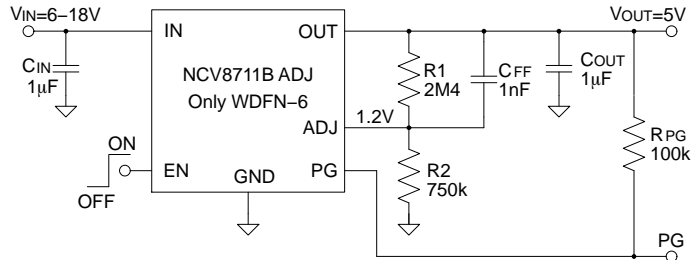
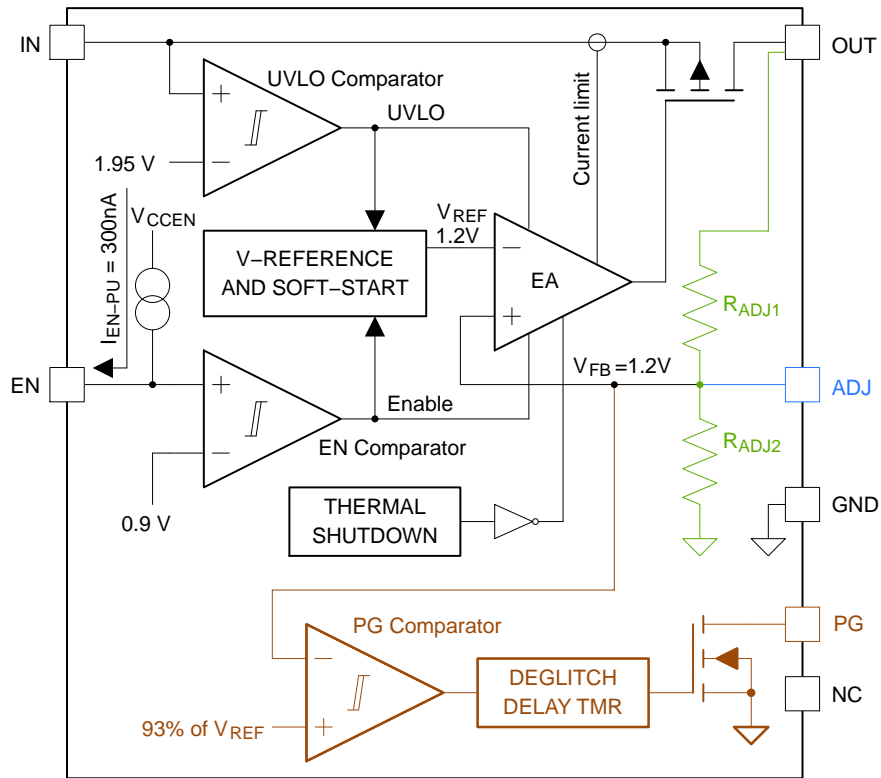

Figure 4. Adjustable Output Voltage Application with PG

$$V_{OUT} = V_{ADJ} \cdot \left( 1 + \frac{R_1}{R_2} \right) + I_{ADJ} \cdot R_1$$

# NCV8711

## SIMPLIFIED BLOCK DIAGRAMS



Note: Blue objects are valid for ADJ version  
 Green objects are valid for FIX version  
 Brown objects are valid for B version (with PG)

Figure 5. Internal Block Diagram

### PIN DESCRIPTION

Pin No. TSOP-5	Pin No. WDFNW6	Pin Name	Description
1	6	IN	Power supply input pin.
2	3	GND	Ground pin.
5	1	OUT	LDO output pin.
3	4	EN	Enable input pin (high – enabled, low – disabled). If this pin is connected to IN pin or if it is left unconnected (pull-up resistor is not required) the device is enabled.
4 (Note 1)	2	ADJ	Adjust input pin. Connect it to the output resistor divider or directly to the OUT pin.
4 (Note 1)	5	PG	Power good output pin. Could be left unconnected or could be connected to GND if not needed. High level for power ok, low level for fail.
4 (Note 1)	2, 5	NC	Not internally connected. This pin can be tied to the ground plane to improve thermal dissipation.
NA	EP	EPAD	Connect the exposed pad to GND.

1. Pin function depends on device version.

**MAXIMUM RATINGS**

Rating	Symbol	Value	Unit
VIN Voltage (Note 2)	V <sub>IN</sub>	-0.3 to 22	V
VOU <sub>T</sub> Voltage	V <sub>OUT</sub>	-0.3 to [(V <sub>IN</sub> + 0.3) or 22 V; whichever is lower]	V
EN Voltage	V <sub>EN</sub>	-0.3 to (V <sub>IN</sub> + 0.3)	V
ADJ Voltage	V <sub>FB/ADJ</sub>	-0.3 to 5.5	V
PG Voltage	V <sub>PG</sub>	-0.3 to (V <sub>IN</sub> + 0.3)	V
Output Current	I <sub>OUT</sub>	Internally limited	mA
PG Current	I <sub>PG</sub>	3	mA
Maximum Junction Temperature	T <sub>J(MAX)</sub>	150	°C
Storage Temperature	T <sub>STG</sub>	-55 to 150	°C
ESD Capability, Human Body Model (Note 3)	ESD <sub>HBM</sub>	2000	V
ESD Capability, Charged Device Model (Note 3)	ESD <sub>CDM</sub>	1000	V

Stresses exceeding those listed in the Maximum Ratings table may damage the device. If any of these limits are exceeded, device functionality should not be assumed, damage may occur and reliability may be affected.

2. Refer to ELECTRICAL CHARACTERISTICS and APPLICATION INFORMATION for Safe Operating Area.

3. This device series incorporates ESD protection and is tested by the following methods:

ESD Human Body Model tested per ANSI/ESDA/JEDEC JS-001, EIA/JESD22-A114 (AEC-Q100-002)

ESD Charged Device Model tested per ANSI/ESDA/JEDEC JS-002, EIA/JESD22-C101 (AEC-Q100-011D)

**THERMAL CHARACTERISTICS** (Note 4)

Characteristic	Symbol	WDFNW6 2x2	TSOP-5	Unit
Thermal Resistance, Junction-to-Air	R <sub>thJA</sub>	63	147	°C/W
Thermal Resistance, Junction-to-Case (top)	R <sub>thJCt</sub>	204	82	°C/W
Thermal Resistance, Junction-to-Case (bottom)	R <sub>thJCb</sub>	15	N/A	°C/W
Thermal Resistance, Junction-to-Board (top)	R <sub>thJBt</sub>	47	113	°C/W
Thermal Characterization Parameter, Junction-to-Case (top)	Ψ <sub>iJCt</sub>	4	22	°C/W
Thermal Characterization Parameter, Junction-to-Board [FEM]	Ψ <sub>iJB</sub>	46	113	°C/W

4. Measured according to JEDEC board specification (board 1S2P, Cu layer thickness 1 oz, Cu area 650 mm<sup>2</sup>, no airflow). Detailed description of the board can be found in JESD51-7.

**ELECTRICAL CHARACTERISTICS** (V<sub>IN</sub> = V<sub>OUT-NOM</sub> + 1 V and V<sub>IN</sub> ≥ 2.7 V, V<sub>EN</sub> = 1.2 V, I<sub>OUT</sub> = 1 mA, C<sub>IN</sub> = C<sub>OUT</sub> = 1.0 μF (effective capacitance – Note 5), T<sub>J</sub> = -40°C to 125°C, ADJ tied to OUT, unless otherwise specified) (Note 6)

Parameter	Test Conditions	Symbol	Min	Typ	Max	Unit
Recommended Input Voltage		V <sub>IN</sub>	2.7	-	18	V
Output Voltage Accuracy	T <sub>J</sub> = -40°C to +85°C	V <sub>OUT</sub>	-1	-	1	%
	T <sub>J</sub> = -40°C to +125°C		-1	-	2	
ADJ Reference Voltage	ADJ version only	V <sub>ADJ</sub>	-	1.2	-	V
ADJ Input Current	V <sub>ADJ</sub> = 1.2 V	I <sub>ADJ</sub>	-0.1	0.01	0.1	μA
Line Regulation	V <sub>IN</sub> = V <sub>OUT-NOM</sub> + 1 V to 18 V and V <sub>IN</sub> ≥ 2.7 V	ΔV <sub>O(ΔVI)</sub>	-	-	0.2	%V <sub>OUT</sub>
Load Regulation	I <sub>OUT</sub> = 0.1 mA to 100 mA	ΔV <sub>O(ΔIO)</sub>	-	-	0.4	%V <sub>OUT</sub>
Quiescent Current (version A)	V <sub>IN</sub> = V <sub>OUT-NOM</sub> + 1 V to 18 V, I <sub>OUT</sub> = 0 mA	I <sub>Q</sub>	-	1.3	2.5	μA
Quiescent Current (version B)	V <sub>IN</sub> = V <sub>OUT-NOM</sub> + 1 V to 18 V, I <sub>OUT</sub> = 0 mA		-	1.8	3.0	
Ground Current	I <sub>OUT</sub> = 100 mA	I <sub>GND</sub>	-	325	450	μA
Shutdown Current (Note 10)	V <sub>EN</sub> = 0 V, I <sub>OUT</sub> = 0 mA, V <sub>IN</sub> = 18 V	I <sub>SHDN</sub>	-	0.35	1.5	μA
Output Current Limit	V <sub>OUT</sub> = V <sub>OUT-NOM</sub> - 100 mV	I <sub>OLIM</sub>	140	250	450	mA
Short Circuit Current	V <sub>OUT</sub> = 0 V	I <sub>OSC</sub>	140	250	450	mA
Dropout Voltage (Note 7)	I <sub>OUT</sub> = 100 mA	V <sub>DO</sub>	-	215	355	mV

# NCV8711

**ELECTRICAL CHARACTERISTICS** ( $V_{IN} = V_{OUT-NOM} + 1$  V and  $V_{IN} \geq 2.7$  V,  $V_{EN} = 1.2$  V,  $I_{OUT} = 1$  mA,  $C_{IN} = C_{OUT} = 1.0$   $\mu$ F (effective capacitance – Note 5),  $T_J = -40^\circ\text{C}$  to  $125^\circ\text{C}$ , ADJ tied to OUT, unless otherwise specified) (Note 6) (continued)

Parameter	Test Conditions	Symbol	Min	Typ	Max	Unit	
Power Supply Ripple Rejection	$V_{IN} = V_{OUT-NOM} + 2$ V $I_{OUT} = 10$ mA	10 Hz	PSRR	–	80	–	dB
		10 kHz	–	70	–		
		100 kHz	–	42	–		
		1 MHz	–	48	–		
Output Noise	$f = 10$ Hz to $100$ kHz, $V_{OUT-NOM} = 5.0$ V	$V_N$	–	240	–	$\mu\text{VRMS}$	
EN Threshold	$V_{EN}$ rising	$V_{EN-TH}$	0.7	0.9	1.05	V	
EN Hysteresis	$V_{EN}$ falling	$V_{EN-HY}$	0.01	0.1	0.2	V	
EN Internal Pull-up Current	$V_{EN} = 1$ V, $V_{IN} = 5.5$ V	$I_{EN-PU}$	0.01	0.3	1	$\mu\text{A}$	
EN Input Leakage Current	$V_{EN} = 18$ V, $V_{IN} = 18$ V	$I_{EN-LK}$	–1	0.05	1	$\mu\text{A}$	
Start-up time (Note 8)	$V_{OUT-NOM} \leq 3.3$ V	$t_{START}$	100	250	500	$\mu\text{s}$	
	$V_{OUT-NOM} > 3.3$ V		300	600	1000		
Internal UVLO Threshold	Ramp $V_{IN}$ up until output is turned on	$V_{IUL-TH}$	1.6	1.95	2.6	V	
Internal UVLO Hysteresis	Ramp $V_{IN}$ down until output is turned off	$V_{IUL-HY}$	0.05	0.2	0.3	V	
PG Threshold (Note 9)	$V_{OUT}$ falling	$V_{PG-TH}$	90	93	96	%	
PG Hysteresis (Note 9)	$V_{OUT}$ rising	$V_{PG-HY}$	0.1	2	4	%	
PG Deglitch Time (Note 9)		$t_{PG-DG}$	75	160	270	$\mu\text{s}$	
PG Delay Time (Note 9)		$t_{PG-DLY}$	120	320	600	$\mu\text{s}$	
PG Output Low Level Voltage (Note 9)	$I_{PG} = 1$ mA	$V_{PG-OL}$	–	0.2	0.4	V	
PG Output Leakage Current (Note 9)	$V_{PG} = 18$ V	$I_{PG-LK}$	–	0.01	1	$\mu\text{A}$	
Thermal Shutdown Temperature	Temperature rising from $T_J = +25^\circ\text{C}$	$T_{SD}$	–	165	–	$^\circ\text{C}$	
Thermal Shutdown Hysteresis	Temperature falling from $T_{SD}$	$T_{SDH}$	–	20	–	$^\circ\text{C}$	

Product parametric performance is indicated in the Electrical Characteristics for the listed test conditions, unless otherwise noted. Product performance may not be indicated by the Electrical Characteristics if operated under different conditions.

5. Effective capacitance, including the effect of DC bias, tolerance and temperature. See the Application Information section for more information.
6. Performance guaranteed over the indicated operating temperature range by design and/or characterization. Production tested at  $T_A = 25^\circ\text{C}$ . Low duty cycle pulse techniques are used during the testing to maintain the junction temperature as close to ambient as possible.
7. Dropout measured when the output voltage falls 100 mV below the nominal output voltage. Limits are valid for all voltage versions.
8. Startup time is the time from EN assertion to point when output voltage is equal to 95% of  $V_{OUT-NOM}$ .
9. Applicable only to version B (device option with power good output). PG threshold and PG hysteresis are expressed in percentage of nominal output voltage.
10. Shutdown current includes EN Internal Pull-up Current.

TYPICAL CHARACTERISTICS

$V_{IN} = V_{OUT-NOM} + 1\text{ V}$  and  $V_{IN} \geq 2.7\text{ V}$ ,  $V_{EN} = 1.2\text{ V}$ ,  $I_{OUT} = 1\text{ mA}$ ,  $C_{OUT} = 1.0\text{ }\mu\text{F}$ , ADJ tied to OUT,  $T_J = 25^\circ\text{C}$ , unless otherwise specified

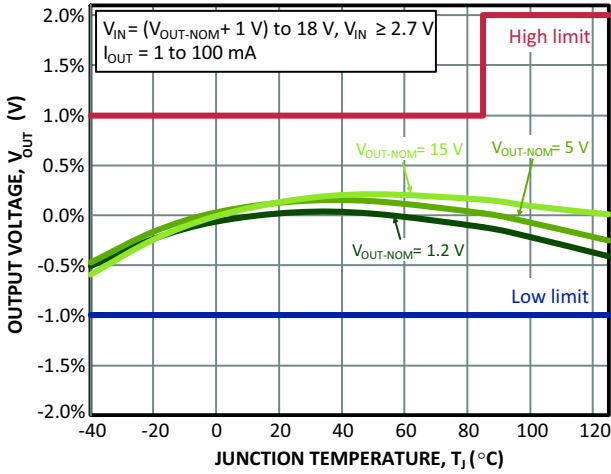

Figure 6. Output Voltage vs. Temperature

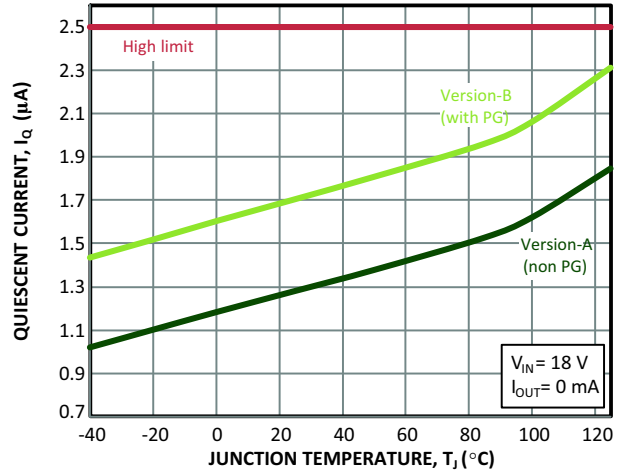

Figure 7. Quiescent Current vs. Temperature

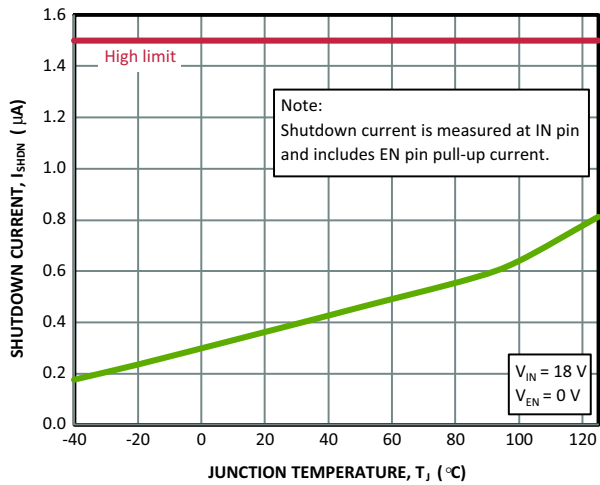

Figure 8. Shutdown Current vs. Temperature

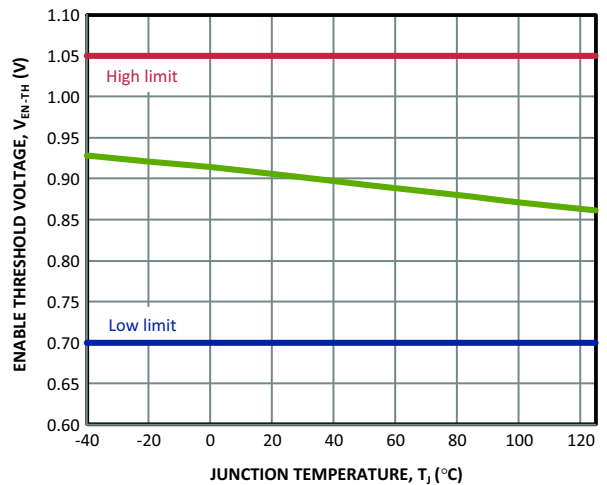

Figure 9. Enable Threshold Voltage vs. Temperature

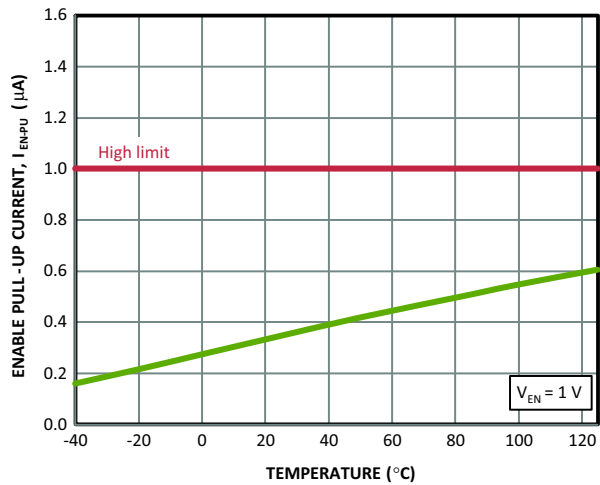

Figure 10. Enable Internal Pull-Up Current vs. Temperature

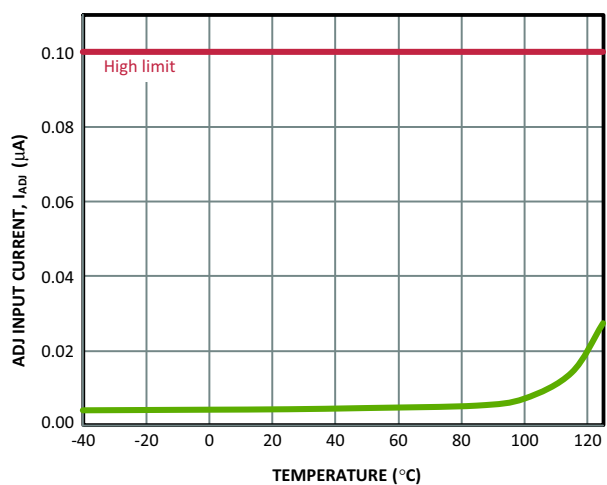

Figure 11. ADJ Input Current vs. Temperature

# NCV8711

## TYPICAL CHARACTERISTICS

$V_{IN} = V_{OUT-NOM} + 1\text{ V}$  and  $V_{IN} \geq 2.7\text{ V}$ ,  $V_{EN} = 1.2\text{ V}$ ,  $I_{OUT} = 1\text{ mA}$ ,  $C_{OUT} = 1.0\text{ }\mu\text{F}$ , ADJ tied to OUT,  $T_J = 25^\circ\text{C}$ , unless otherwise specified

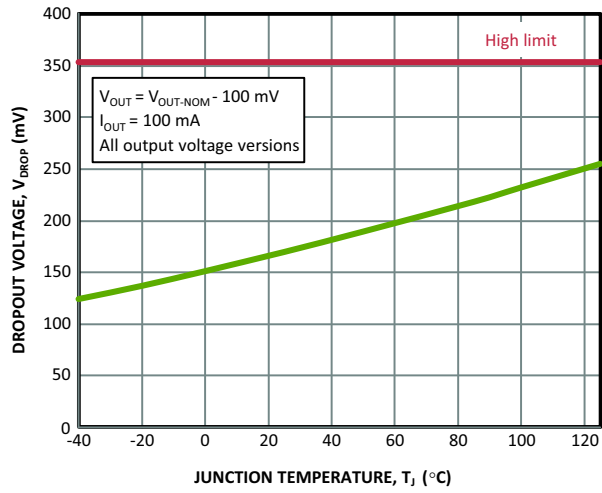

Figure 12. Dropout Voltage vs. Temperature

TYPICAL CHARACTERISTICS

$V_{IN} = V_{OUT-NOM} + 1\text{ V}$  and  $V_{IN} \geq 2.7\text{ V}$ ,  $V_{EN} = 1.2\text{ V}$ ,  $I_{OUT} = 1\text{ mA}$ ,  $C_{OUT} = 1.0\text{ }\mu\text{F}$ , ADJ tied to OUT,  $T_J = 25^\circ\text{C}$ , unless otherwise specified

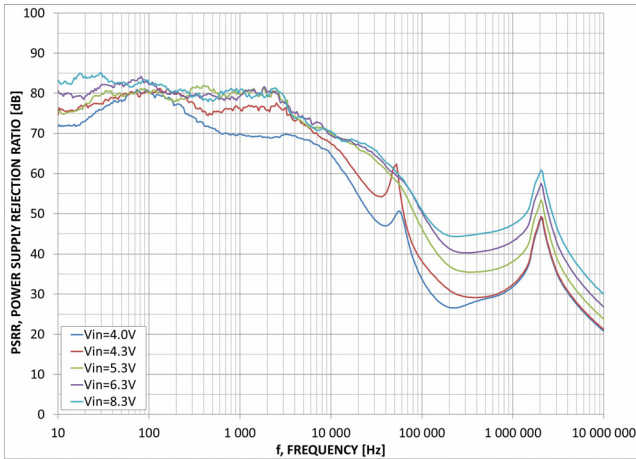

Figure 13. PSRR – FIX–3.3 V,  $C_{OUT} = 1\text{ }\mu\text{F}$ ,  $I_{OUT} = 100\text{ mA}$

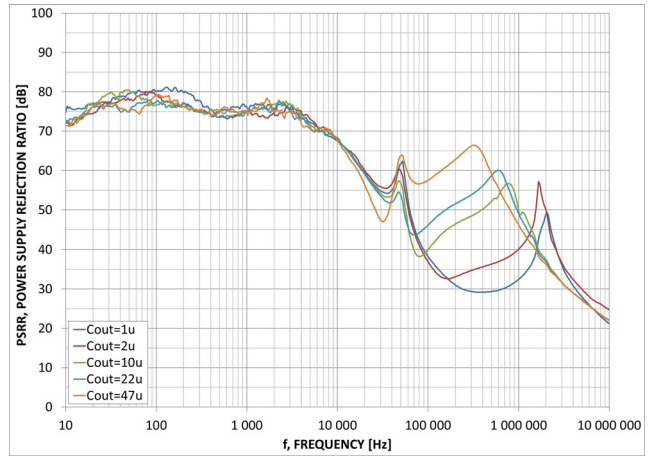

Figure 14. PSRR – FIX–3.3 V,  $V_{IN} = 4.3\text{ V}$ ,  $I_{OUT} = 100\text{ mA}$

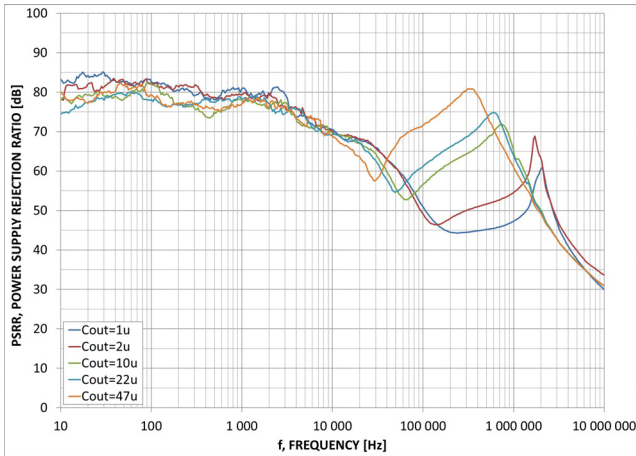

Figure 15. PSRR – FIX–3.3 V,  $V_{IN} = 8.3\text{ V}$ ,  $I_{OUT} = 100\text{ mA}$

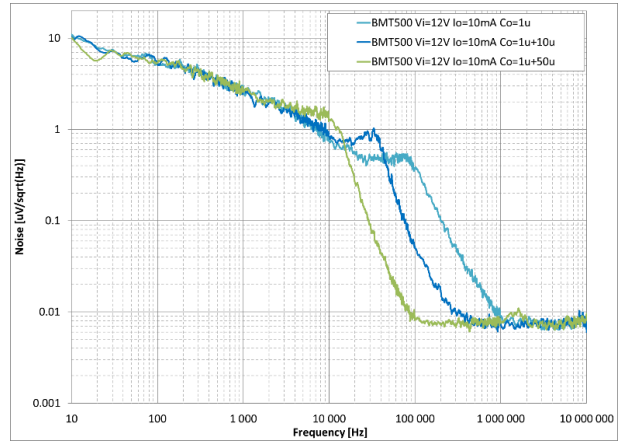

Figure 16. Noise – FIX – 5.0 V,  $I_{OUT} = 10\text{ mA}$ , Different  $C_{OUT}$

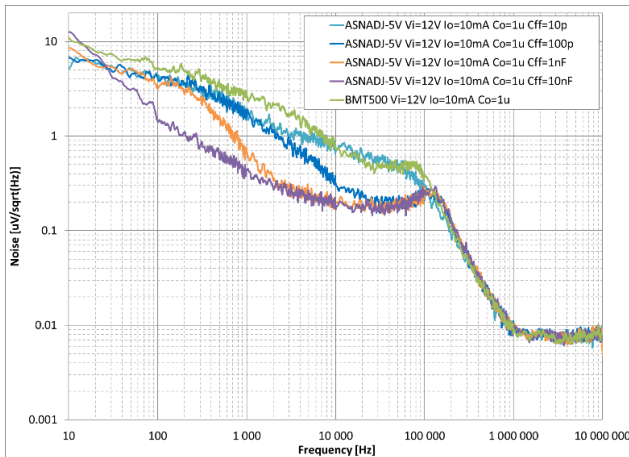

Figure 17. Noise – ADJ–set–5.0 V with Different  $C_{FF}$  and FIX – 5.0 V

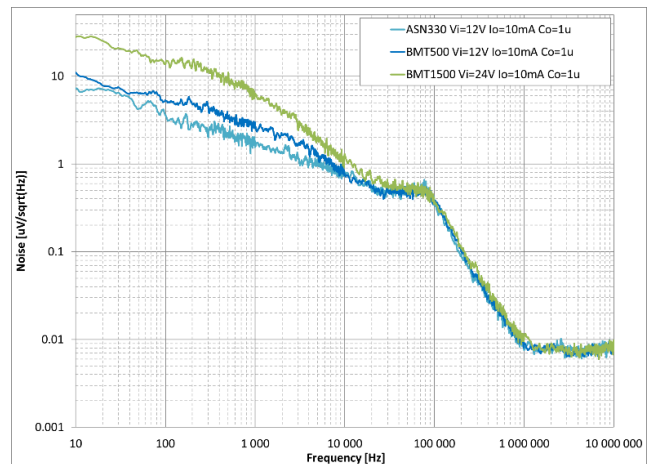

Figure 18. Noise – FIX,  $I_{OUT} = 10\text{ mA}$ ,  $C_{OUT} = 1\text{ }\mu\text{F}$ , Different  $V_{OUT}$



# NCV8711

## ORDERING INFORMATION

Part Number	Marking	Voltage Option (V <sub>OUT-NOM</sub> )	Version	Package	Shipping
NCV8711ASNADJT1G	GGA	ADJ	Without PG	TSOP-5 (Pb-Free)	3000 / Tape & Reel
NCV8711ASN300T1G	GGC	3.0 V			
NCV8711ASN330T1G	GGD	3.3 V			
NCV8711ASN500T1G	GGE	5.0 V			
NCV8711BMTWADJTBG	GA	ADJ	With PG	WDFNW6 (Pb-Free)	3000 / Tape & Reel
NCV8711BMTW300TBG	GC	3.0 V			
NCV8711BMTW330TBG	GD	3.3 V			
NCV8711BMTW500TBG	GE	5.0 V			

NOTE: To order other package, voltage version or PG / non PG variant, please contact your ON Semiconductor sales representative.

# MECHANICAL CASE OUTLINE PACKAGE DIMENSIONS

ON Semiconductor®



SCALE 2:1

## TSOP-5 CASE 483 ISSUE N

DATE 12 AUG 2020



NOTES:

1. DIMENSIONING AND TOLERANCING PER ASME Y14.5M, 1994.
2. CONTROLLING DIMENSION: MILLIMETERS.
3. MAXIMUM LEAD THICKNESS INCLUDES LEAD FINISH THICKNESS. MINIMUM LEAD THICKNESS IS THE MINIMUM THICKNESS OF BASE MATERIAL.
4. DIMENSIONS A AND B DO NOT INCLUDE MOLD FLASH, PROTRUSIONS, OR GATE BURRS. MOLD FLASH, PROTRUSIONS, OR GATE BURRS SHALL NOT EXCEED 0.15 PER SIDE. DIMENSION A.
5. OPTIONAL CONSTRUCTION: AN ADDITIONAL TRIMMED LEAD IS ALLOWED IN THIS LOCATION. TRIMMED LEAD NOT TO EXTEND MORE THAN 0.2 FROM BODY.

DIM	MILLIMETERS	
	MIN	MAX
A	2.85	3.15
B	1.35	1.65
C	0.90	1.10
D	0.25	0.50
G	0.95 BSC	
H	0.01	0.10
J	0.10	0.26
K	0.20	0.60
M	0°	10°
S	2.50	3.00

### SOLDERING FOOTPRINT\*



\*For additional information on our Pb-Free strategy and soldering details, please download the ON Semiconductor Soldering and Mounting Techniques Reference Manual, SOLDERRM/D.

### GENERIC MARKING DIAGRAM\*



- XXX = Specific Device Code  
 A = Assembly Location  
 Y = Year  
 W = Work Week  
 ■ = Pb-Free Package
- XXX = Specific Device Code  
 M = Date Code  
 ■ = Pb-Free Package

(Note: Microdot may be in either location)

\*This information is generic. Please refer to device data sheet for actual part marking. Pb-Free indicator, "G" or microdot "■", may or may not be present.

DOCUMENT NUMBER:	98ARB18753C	Electronic versions are uncontrolled except when accessed directly from the Document Repository. Printed versions are uncontrolled except when stamped "CONTROLLED COPY" in red.
DESCRIPTION:	TSOP-5	PAGE 1 OF 1

ON Semiconductor and ON are trademarks of Semiconductor Components Industries, LLC dba ON Semiconductor or its subsidiaries in the United States and/or other countries. ON Semiconductor reserves the right to make changes without further notice to any products herein. ON Semiconductor makes no warranty, representation or guarantee regarding the suitability of its products for any particular purpose, nor does ON Semiconductor assume any liability arising out of the application or use of any product or circuit, and specifically disclaims any and all liability, including without limitation special, consequential or incidental damages. ON Semiconductor does not convey any license under its patent rights nor the rights of others.

# MECHANICAL CASE OUTLINE

## PACKAGE DIMENSIONS

ON Semiconductor®



### WDFNW6 2x2, 0.65P CASE 511DW ISSUE B

DATE 15 JUN 2018

SCALE 4:1

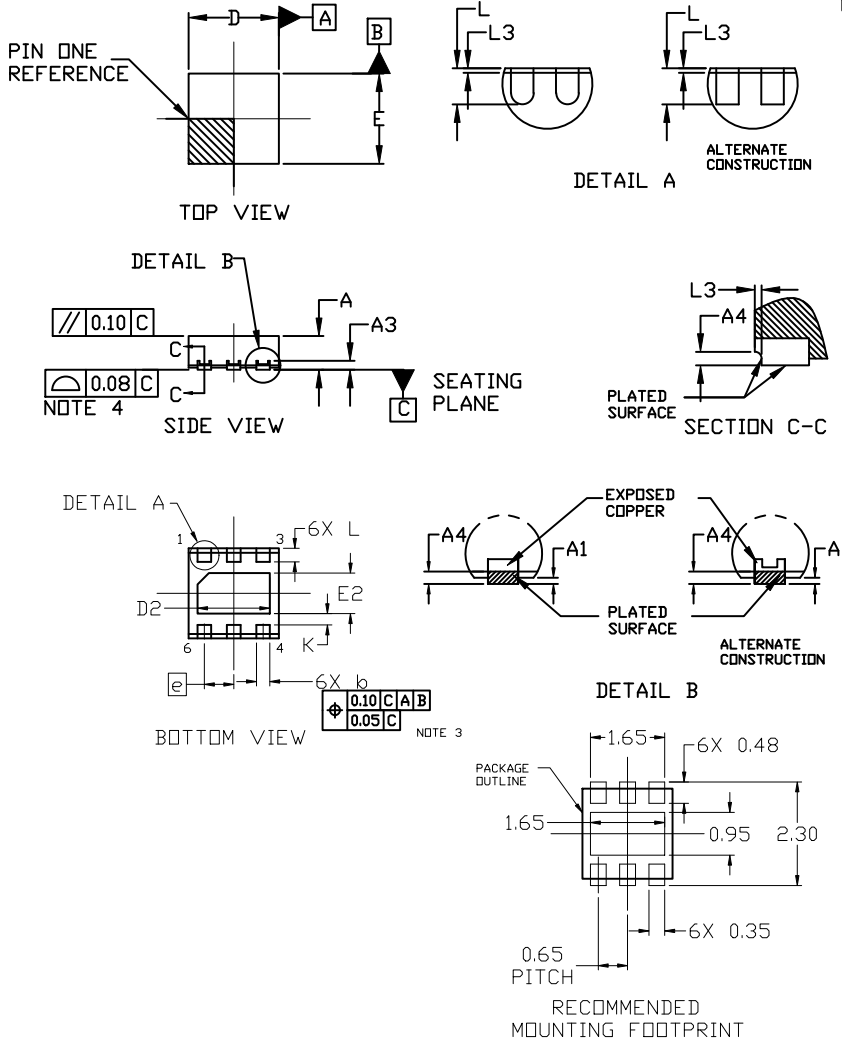

**NOTES:**

1. DIMENSIONING AND TOLERANCING PER ASME Y14.5M, 1994.
2. CONTROLLING DIMENSION: MILLIMETERS
3. DIMENSION *b* APPLIES TO PLATED TERMINALS AND IS MEASURED BETWEEN 0.15 AND 0.30MM FROM THE TERMINAL TIP.
4. COPLANARITY APPLIES TO THE EXPOSED PAD AS WELL AS THE TERMINALS.
5. THIS DEVICE CONTAINS WETTABLE FLANK DESIGN FEATURES TO AID IN FILLET FORMATION ON THE LEADS DURING MOUNTING.

DIM	MILLIMETERS		
	MIN.	NOM.	MAX.
A	0.70	0.75	0.80
A1	---	---	0.05
A3	0.20 REF		
A4	0.10	---	---
<i>b</i>	0.25	0.30	0.35
D	1.90	2.00	2.10
D2	1.50	1.60	1.70
E	1.90	2.00	2.10
E2	0.80	0.90	1.00
<i>e</i>	0.65 BSC		
K	0.25 REF		
L	0.25	0.30	0.35
L3	0.05 REF		

**GENERIC MARKING DIAGRAM\***

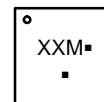

- M = Month Code
- = Pb-Free Package

(Note: Microdot may be in either location)

\*This information is generic. Please refer to device data sheet for actual part marking. Pb-Free indicator, "G" or microdot "▪", may or may not be present. Some products may not follow the Generic Marking.

<b>DOCUMENT NUMBER:</b>	<b>98AON79327G</b>	Electronic versions are uncontrolled except when accessed directly from the Document Repository. Printed versions are uncontrolled except when stamped "CONTROLLED COPY" in red.
<b>DESCRIPTION:</b>	<b>WDFNW6 2x2, 0.65P</b>	<b>PAGE 1 OF 1</b>

ON Semiconductor and ON are trademarks of Semiconductor Components Industries, LLC dba ON Semiconductor or its subsidiaries in the United States and/or other countries. ON Semiconductor reserves the right to make changes without further notice to any products herein. ON Semiconductor makes no warranty, representation or guarantee regarding the suitability of its products for any particular purpose, nor does ON Semiconductor assume any liability arising out of the application or use of any product or circuit, and specifically disclaims any and all liability, including without limitation special, consequential or incidental damages. ON Semiconductor does not convey any license under its patent rights nor the rights of others.

ON Semiconductor and  are trademarks of Semiconductor Components Industries, LLC dba ON Semiconductor or its subsidiaries in the United States and/or other countries. ON Semiconductor owns the rights to a number of patents, trademarks, copyrights, trade secrets, and other intellectual property. A listing of ON Semiconductor's product/patent coverage may be accessed at [www.onsemi.com/site/pdf/Patent-Marking.pdf](http://www.onsemi.com/site/pdf/Patent-Marking.pdf). ON Semiconductor reserves the right to make changes without further notice to any products herein. ON Semiconductor makes no warranty, representation or guarantee regarding the suitability of its products for any particular purpose, nor does ON Semiconductor assume any liability arising out of the application or use of any product or circuit, and specifically disclaims any and all liability, including without limitation special, consequential or incidental damages. Buyer is responsible for its products and applications using ON Semiconductor products, including compliance with all laws, regulations and safety requirements or standards, regardless of any support or applications information provided by ON Semiconductor. "Typical" parameters which may be provided in ON Semiconductor data sheets and/or specifications can and do vary in different applications and actual performance may vary over time. All operating parameters, including "Typicals" must be validated for each customer application by customer's technical experts. ON Semiconductor does not convey any license under its patent rights nor the rights of others. ON Semiconductor products are not designed, intended, or authorized for use as a critical component in life support systems or any FDA Class 3 medical devices or medical devices with a same or similar classification in a foreign jurisdiction or any devices intended for implantation in the human body. Should Buyer purchase or use ON Semiconductor products for any such unintended or unauthorized application, Buyer shall indemnify and hold ON Semiconductor and its officers, employees, subsidiaries, affiliates, and distributors harmless against all claims, costs, damages, and expenses, and reasonable attorney fees arising out of, directly or indirectly, any claim of personal injury or death associated with such unintended or unauthorized use, even if such claim alleges that ON Semiconductor was negligent regarding the design or manufacture of the part. ON Semiconductor is an Equal Opportunity/Affirmative Action Employer. This literature is subject to all applicable copyright laws and is not for resale in any manner.

## PUBLICATION ORDERING INFORMATION

### LITERATURE FULFILLMENT:

Email Requests to: [orderlit@onsemi.com](mailto:orderlit@onsemi.com)

ON Semiconductor Website: [www.onsemi.com](http://www.onsemi.com)

### TECHNICAL SUPPORT

North American Technical Support:  
Voice Mail: 1 800-282-9855 Toll Free USA/Canada  
Phone: 011 421 33 790 2910

Europe, Middle East and Africa Technical Support:

Phone: 00421 33 790 2910

For additional information, please contact your local Sales Representative