

# 先进负载管理开关

## FPF1504 / FPF1504L

### 说明

FPF1504/FPF1504L是IntelliMAX™系列的低RDS P沟道MOSFET负载开关。集成的压摆率控制可防止过量浪涌电流干扰电源应用中通用的电容负载的电源电压轨。

此外, FPF1504/FPF1504L具有输出放电功能。

输入电压的工作范围为1.0 V到3.6 V, 可满足当今移动设备的供电要求。开关控制是通过能够直接连接嵌入式处理器中的低压CMOS控制信号和GPIO的逻辑输入(ON引脚)来实现的。

### 特性

- 1.0至3.6 V的输入电压工作范围
- 典型RDS(ON):
  - ◆ 15 mΩ(V<sub>IN</sub> = 3.3 V时)
  - ◆ 20 mΩ(V<sub>IN</sub> = 1.8 V时)
  - ◆ V<sub>IN</sub> = 1.0 V时为40 mΩ
- 转换速率控制
- 输出放电功能
- 小于1 μA的低静态电流(V<sub>ON</sub> = V<sub>IN</sub>)
- 静电放电保护: 4000 V HBM, 2000 V CDM
- 兼容GPIO/CMOS的使能电路
- 高电平有效版本和低电平有效版本

### 应用

- 移动设备和智能手机
- 便携式媒体设备
- 数码相机
- 高级笔记本电脑、超便携移动个人电脑和移动互联网设备
- 便携式医疗设备
- 全球定位系统和导航设备



图 1. 框图



ON Semiconductor®

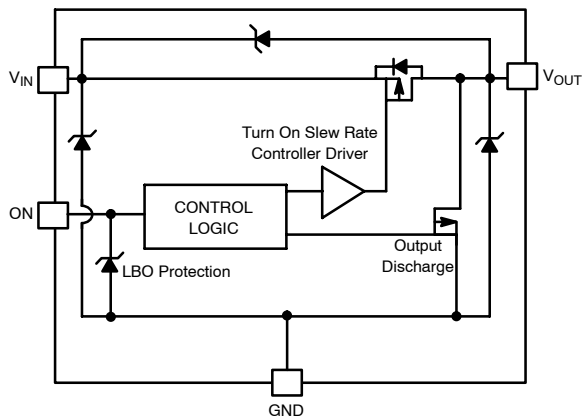

WLCSP4  
CASE 567RH

### MARKING DIAGRAM

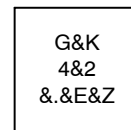

- G = 1<sup>st</sup> Digit of 2 Digit Device ID Mark
- &K = 2-Digits Lot Run Traceability Code
- 4 = 2<sup>nd</sup> Digit of 2 Digit Device ID Mark
- &2 = 2-digit Date Code Format
- &. = Pin 1 Identifier
- &E = Space Designator
- &Z = Assembly Plant Code

### 订购信息

请参阅本数据表第 2 页封装尺寸部分的详细订购和装运信息。

# FPF1504 / FPF1504L

## 订购信息

器件型号	顶标	1.8 V <sub>IN</sub>	输入缓冲	输出放电	ON引脚动作	封装
		的开关(典型值)				
FPF1504UCX	G4	20 mΩ	CMOS	是	高电平有效	4引脚, WLCSP, 0.5 mm引脚间距
FPF1504BUCX	G4	20 mΩ	CMOS	是	高电平有效	4引脚, WLCSP封装, 背部层压, 0.5 mm引脚间距
FPF1504LUCX	GZ	20 mΩ	CMOS	是	低电平有效	4引脚, WLCSP, 0.5 mm引脚间距
FPF1504LBUCX	G4	20 mΩ	CMOS	是	低电平有效	4引脚, WLCSP封装, 背部层压, 0.5 mm引脚间距

## 应用框图

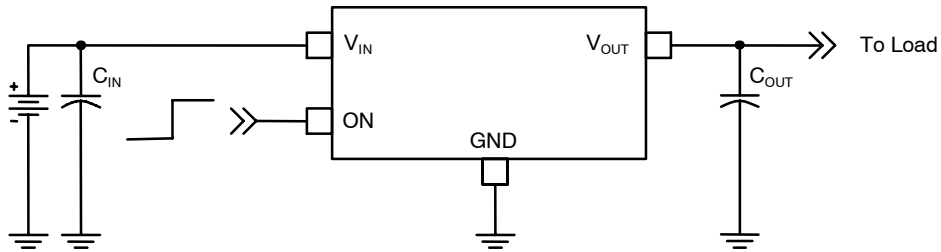

- 说明:
1.  $C_{IN} = 1 \text{ mF}$ , X5R, 0603, 例如 Murata GRM185R60J105KE26.
  2.  $C_{OUT} = 1 \text{ mF}$ , X5R, 0805, 例如 Murata GRM216R61A105KA01.

图 2. 典型应用

## 引脚布局



图 3. 1 x 1 毫米 WLCSP 封装, 凸块向下



图 4. 1 x 1 毫米 WLCSP 封装, 凸块向上

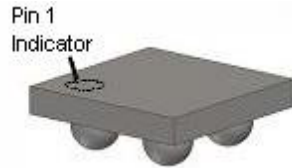

图 5. 引脚分配(顶视图/俯视图)

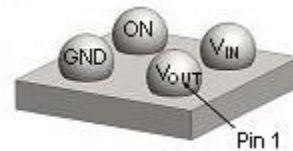

图 6. 引脚布局(底视图)

# FPF1504 / FPF1504L

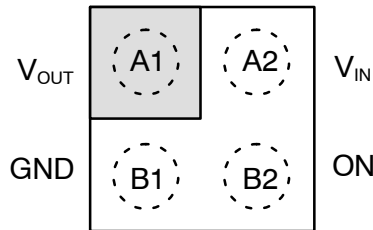
## 引脚说明

引脚号	名称	说明
A1	V <sub>OUT</sub>	开关输出
A2	V <sub>IN</sub>	电源输入；电源开关的输入
B1	GND	接地
B2	ON	导通/关断控制

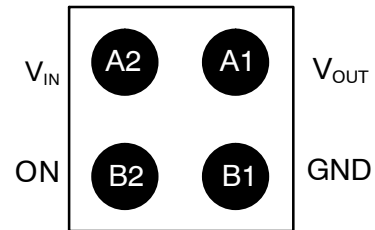
## 绝对最大额定

符号	参数	最小值	最大值	单位
V <sub>IN</sub>	V <sub>IN</sub> , V <sub>OUT</sub> , V <sub>ON</sub> 到 GND	-0.3	4.0	V
I <sub>SW</sub>	连续开关电流最大值		1.0	A
P <sub>D</sub>	功耗(T <sub>A</sub> = 25°C)		1.0	W
T <sub>STG</sub>	存储结温	-65	150	°C
T <sub>A</sub>	工作温度范围	-40	85	°C
θ <sub>JA</sub>	结至环境热阻	1S2P, 1 热阻通过		95
		1S2P, 无热阻通过		187
ESD	静电放电能力	人体模型, JESD22-A114		4
		充电器件模式, JESD22-C101		2
				kV

Stresses exceeding those listed in the Maximum Ratings table may damage the device. If any of these limits are exceeded, device functionality should not be assumed, damage may occur and reliability may be affected.

(参考译文)

如果电压超过最大额定值表中列出的值范围，器件可能会损坏。如果超过任何这些限值，将无法保证器件功能，可能会导致器件损坏，影响可靠性。

## 推荐工作条件

符号	参数	最小值	最大值	单位
V <sub>IN</sub>	电源电压	1.0	3.0	V
T <sub>A</sub>	工作环境温度	-40	85	°C

Functional operation above the stresses listed in the Recommended Operating Ranges is not implied. Extended exposure to stresses beyond the Recommended Operating Ranges limits may affect device reliability.

(参考译文)

高于推荐工作范围表格中所列电压时，不保证能够正常运行。长时间在推荐工作范围表格中规定范围以外的电压下运行，可能会影响器件的可靠性。

## FPF1504 / FPF1504L

### 电气特性

除非另有说明,  $V_{IN} = 1.0$  至  $3.6$  V,  $T_A = -40$  至  $+85^\circ\text{C}$ ,  $V_{IN} = 3.3$  V,  $T_A = 25^\circ\text{C}$  时为典型值。

符号	参数	工作条件	最小值	典型值	最大值	单位
----	----	------	-----	-----	-----	----

### 基本工作

$V_{IN}$	电源电压		1.0		3.7	V	
$I_{Q(OFF)}$	关断电源电流	FPF1504	$V_{ON} = \text{接地}, V_{OUT} = \text{开路}$		0.25	$\mu\text{A}$	
		FPF1504L	$V_{ON} = V_{IN}, V_{OUT} = \text{开路}$		0.3		
$I_{SD(OFF)}$	关断开关电流	FPF1504	$V_{ON} = \text{GND}, V_{OUT} = \text{GND}$		0.25		
		FPF1504L	$V_{ON} = V_{IN}, V_{OUT} = \text{GND}$		0.3		
$I_Q$	静态电流	FPF1504	$I_{OUT} = 0 \text{ mA}, V_{IN} = 3.6 \text{ V}, V_{ON} = V_{IN}$		0.08		
			$I_{OUT} = 0 \text{ mA}, V_{ON} = V_{IH(MIN)}$		0.75		
		FPF1504L	$I_{OUT} = 0 \text{ mA}, V_{ON} = \text{GND}$		0.08		
			$I_{OUT} = 0 \text{ mA}, V_{ON} = V_{IL(MAX)}$		0.95		
$R_{ON}$	导通电阻		$V_{IN} = 3.3 \text{ V}, I_{OUT} = 200 \text{ mA}, T_A = 25^\circ\text{C}$		15	30	$\text{m}\Omega$
			$V_{IN} = 1.8 \text{ V}, I_{OUT} = 200 \text{ mA}, T_A = 25^\circ\text{C}$		20	40	
			$V_{IN} = 1.25 \text{ V}, I_{OUT} = 200 \text{ mA}, T_A = 25^\circ\text{C}$		30		
			$V_{IN} = 1.0 \text{ V}, I_{OUT} = 200 \text{ mA}, T_A = 25^\circ\text{C}$		40	80	
			$V_{IN} = 1.8 \text{ V}, I_{OUT} = 200 \text{ mA}, T_A = 85^\circ\text{C}$ (Note 3)				
$R_{PD}$	输出放电下拉电阻		$V_{ON} = 0 \text{ V or } V_{IN}, I_{OUT} = -20 \text{ mA}$		65	95	$\Omega$
$V_{IH}$	导通输入逻辑高电压	FPF1504		0.8		V	
$V_{IL}$	导通输入逻辑低电压	FPF1504			0.3		
$I_{ON}$	导通输入漏电流				1	$\mu\text{A}$	

### 动态特性

$t_{DON}$	导通延迟 (4)	FPF1504	$R_L = 10 \Omega, C_L = 0.1 \mu\text{F}, V_{IN} = 3.3 \text{ V}, T_A = 25^\circ\text{C}$		80	$\mu\text{s}$	
$t_R$	$V_{OUT}$ 上升时间 (Note 4)	FPF1504			130		
$t_{ON}$	导通时间 (Note 4)	FPF1504			210		
$t_{DON}$	导通延迟 (Note 4)	FPF1504	$R_L = 500 \Omega, C_L = 0.1 \mu\text{F}, V_{IN} = 3.3 \text{ V}, T_A = 25^\circ\text{C}$		70	$\mu\text{s}$	
		FPF1504L			95		
$t_R$	$V_{OUT}$ 上升时间 (Note 4)	FPF1504			110		150
		FPF1504L			115		
$t_{ON}$	导通时间 (Note 4)	FPF1504			180		250
		FPF1504L			210		
$t_{DOFF}$	关断延迟 (Note 4)	FPF1504	$R_L = 10 \Omega, C_L = 0.1 \mu\text{F}, V_{IN} = 3.3 \text{ V}, T_A = 25^\circ\text{C}$		25	$\mu\text{s}$	
$t_F$	$V_{OUT}$ 下降时间 (Note 4)	FPF1504			2		
$t_{OFF}$	关断时间 (Note 4)	FPF1504			27		

# FPF1504 / FPF1504L

## 电气特性 (continued)

除非另有说明,  $V_{IN} = 1.0$  至  $3.6$  V,  $T_A = -40$  至  $+85^\circ\text{C}$ ,  $V_{IN} = 3.3$  V,  $T_A = 25^\circ\text{C}$  时为典型值。

符号	参数	工作条件	最小值	典型值	最大值	单位
----	----	------	-----	-----	-----	----

### 动态特性

符号	参数	FPF1504	$R_L = 500 \Omega, C_L = 0.1 \mu\text{F},$ $V_{IN} = 3.3 \text{ V}, T_A = 25^\circ\text{C}$	最小值	典型值	最大值	单位
		FPF1504L					
$t_{\text{DOFF}}$	关断延迟 (Note 4)	FPF1504			25		$\mu\text{s}$
		FPF1504L					
$t_F$	$V_{\text{OUT}}$ 下降时间 (Note 4)	FPF1504			12		
		FPF1504L					
$t_{\text{OFF}}$	关断时间 (Note 4)	FPF1504			37		
		FPF1504L					

Product parametric performance is indicated in the Electrical Characteristics for the listed test conditions, unless otherwise noted. Product performance may not be indicated by the Electrical Characteristics if operated under different conditions.

(参考译文)

除非另有说明, “电气特性”表格中列出的是所列测试条件下的产品性能参数。如果在不同条件下运行, 产品性能可能与“电气特性”表格中所列性能参数不一致。

3. 该参数通过设计和特性得到保证, 无需生产测试。

4.  $t_{\text{DON}}/t_{\text{DOFF}}/t_R/t_F$  在中进行定义图7。

5. 断开时, 输出放电路径开启。

### 时序图 – FPF1504

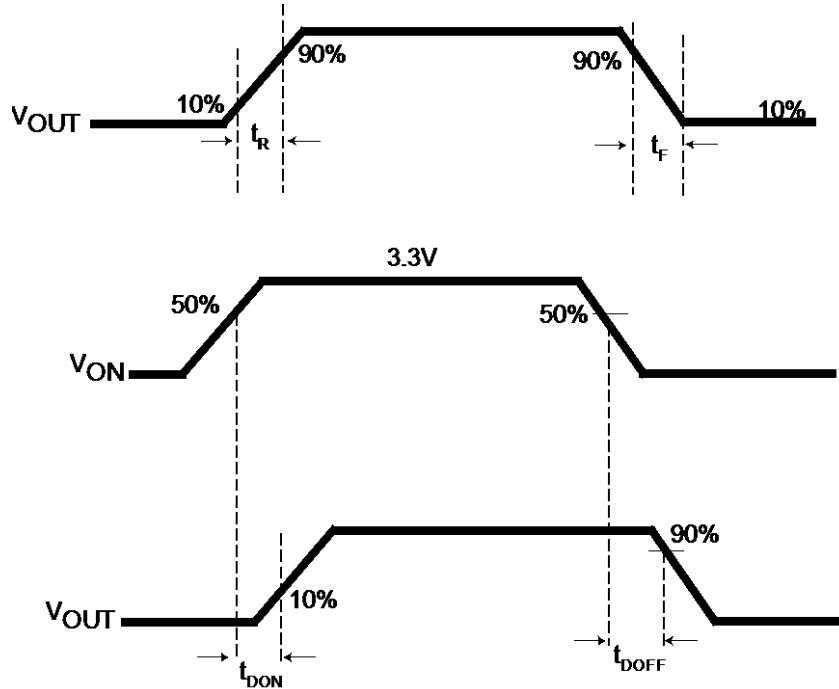

- 说明:
- $t_{\text{ON}} = t_R + t_{\text{DON}}$ .
  - $t_{\text{OFF}} = t_F + t_{\text{DOFF}}$ .

图 7. FPF1504时序图

# FPF1504 / FPF1504L

## FPF1504的典型性能特征

仅适用于高电平有效版本。



图 1. 关断电流与温度的关系



图 2. 关断电流与电源电压的关系

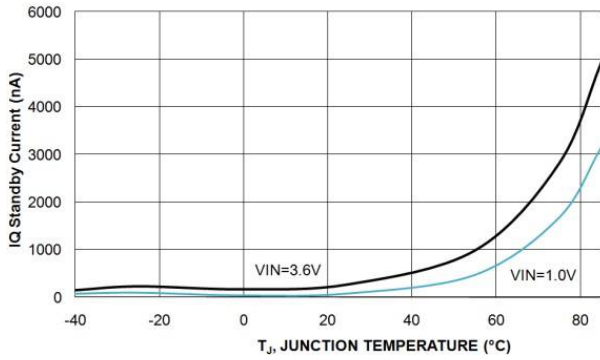

图 3. 关断电源电流与温度的关系

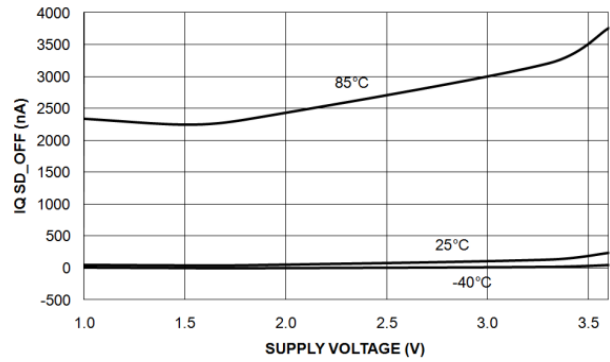

图 4. 关断电源电流与电源电压的关系

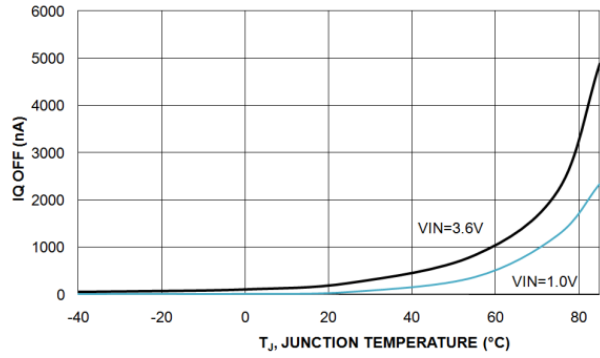

图 5. 关断电源电流与电源电压的关系

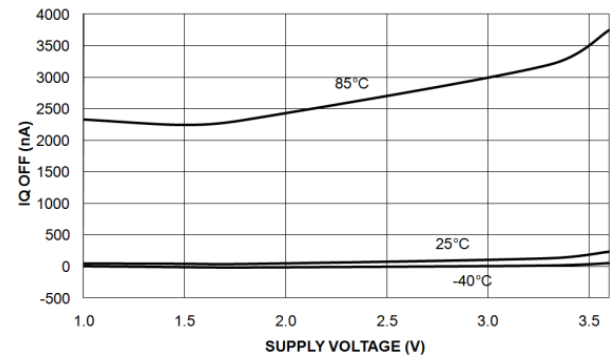

图 6. 静态电流与电源电压的关系  
(V<sub>ON</sub> = V<sub>IN</sub>)

# PPF1504 / PPF1504L

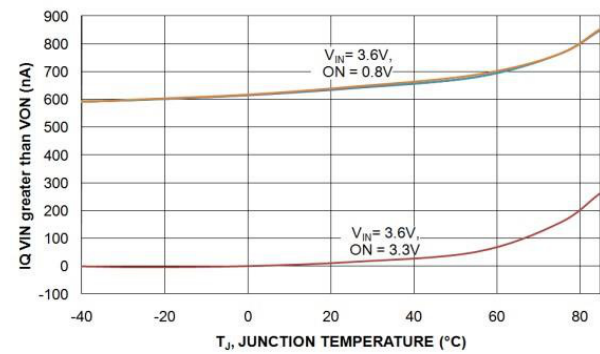
## PPF1504的典型性能特征

仅适用于高电平有效版本。

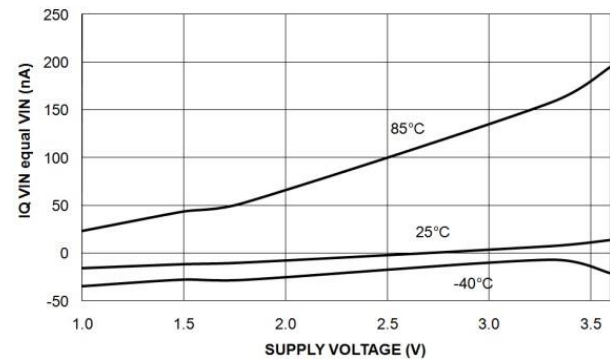

图 7.  $R_{ON}$ 与温度的关系



图 8.  $R_{ON}$ 与温度的关系

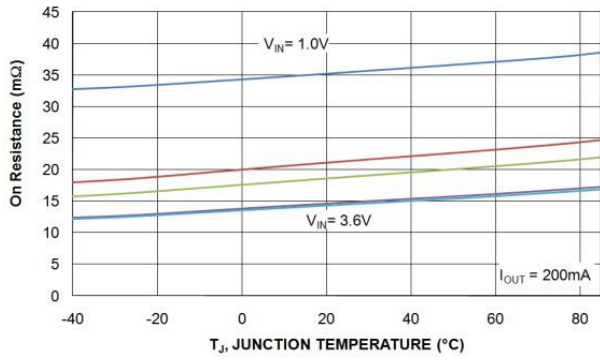

图 9.  $V_{OUT}$ 上升/下降时间与温度的关系  
( $R_L = 10\Omega$ )

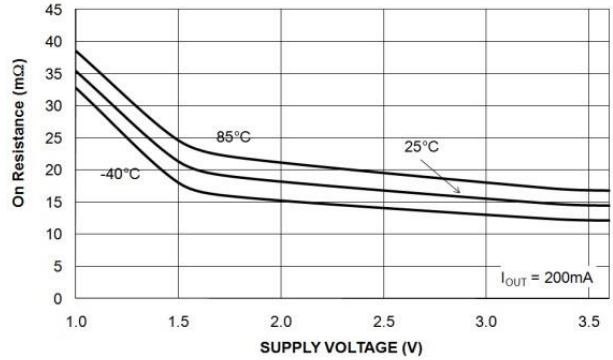

图 10.  $V_{OUT}$ 导通/关闭延迟与温度的关系  
( $R_L = 10\Omega$ )

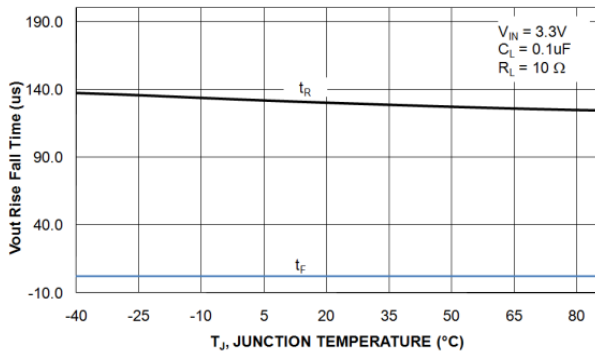

图 11.  $V_{OUT}$ 上升/下降时间与温度的关系  
( $R_L = 500\Omega$ )

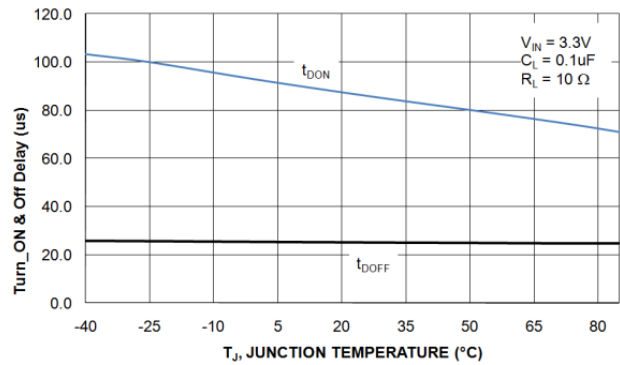

图 12.  $V_{OUT}$ 导通/关闭延迟与温度的关系  
( $R_L = 500\Omega$ )

# FPF1504 / FPF1504L

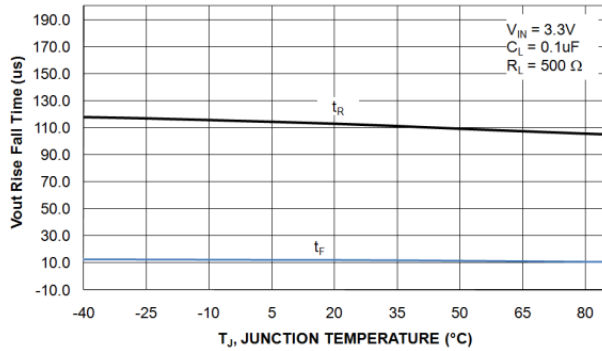
## FPF1504的典型性能特征

仅适用于高电平有效版本。

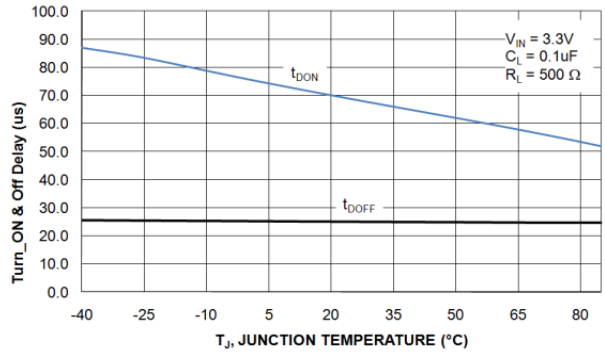

图 13. 导通响应  
( $V_{IN} = 3.3\text{ V}$ ,  $C_{OUT} = 0.1\ \mu\text{F}$ ,  $R_L = 10\ \Omega$ )



图 14. 关断响应  
( $V_{IN} = 3.3\text{ V}$ ,  $C_{OUT} = 0.1\ \mu\text{F}$ ,  $R_L = 10\ \Omega$ )

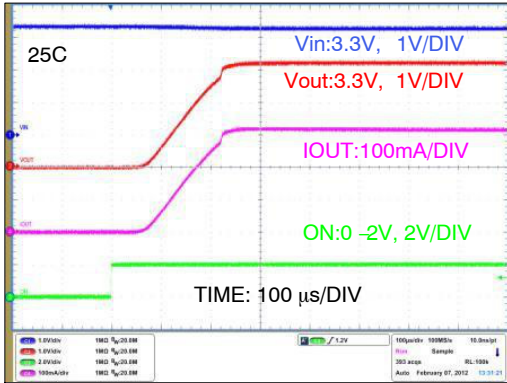

图 15. 导通响应  
( $V_{IN} = 3.3\text{ V}$ ,  $C_{OUT} = 0.1\ \mu\text{F}$ ,  $R_L = 500\ \Omega$ )

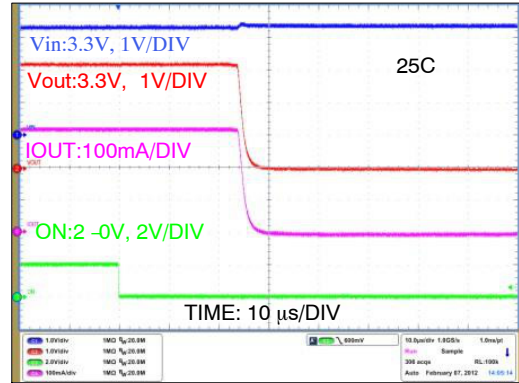

图 16. 关断响应  
( $V_{IN} = 3.3\text{ V}$ ,  $C_{OUT} = 0.1\ \mu\text{F}$ ,  $R_L = 500\ \Omega$ )

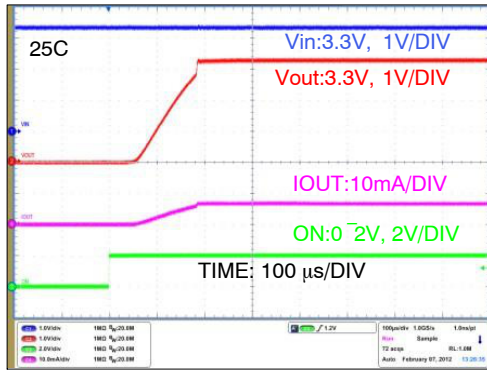

应用信息

输入电容

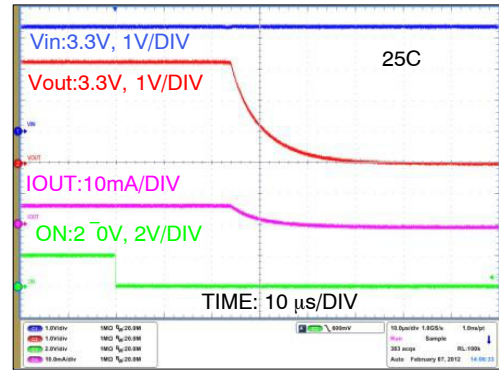
IntelliMAX开关无需输入电容。为了降低设备的浪涌电流，建议靠近VIN引脚放置一个0.1 μF的电容CIN。使用更大的CIN可进一步降低开关导通至更大的电容负载时造成的电压跌落。

输出电容

IntelliMAX开关无需输出电容亦可工作。如果断开时应用电路板寄生电感使得VOUT低于GND，必须在VOUT和GND引脚之间放置一个0.1 μF电容COUT。

下降时间

设备输出下降时间可以根据如下所示外部元件RC常数计算出来。

$$t_F = R_L \times C_L \times 2.2 \quad (\text{eq. 1})$$

其中，下降时间tF为90%至10%，RL为输出负载，CL为输出电容。

同一等式也适用于带下拉输出电阻的设备，则RL由并联下拉电阻和外部输出电阻级联所替代，如下所示：

$$t_F = \frac{R_L \times R_{PD} \times C_L}{R_L + R_{PD}} \times 2.2 \quad (\text{eq. 2})$$

其中，tF为90%至10%的下降时间，RL为输出负载，R<sub>PD</sub>为输出下拉电阻(65 Ω典型值L)，CL为输出电容。

建议焊盘模式和布局

为获得最佳热性能和最低电感与寄生影响，建议输入、输出线路短路，电容尽可能靠近设备。以下建议布局，可使设备实现最佳性能。



图 17. 建议焊盘模式和布局

以下信息适用到下一个页面上的WLCSP封装尺寸：

产品规格尺寸

产品				
FPF1504UCX	960 μm ±30 μm	960 μm ±30 μm	0.230 mm	0.230 mm
FPF1504BUCX				
FPF1504LUCX				
FPF1504LBUCX				

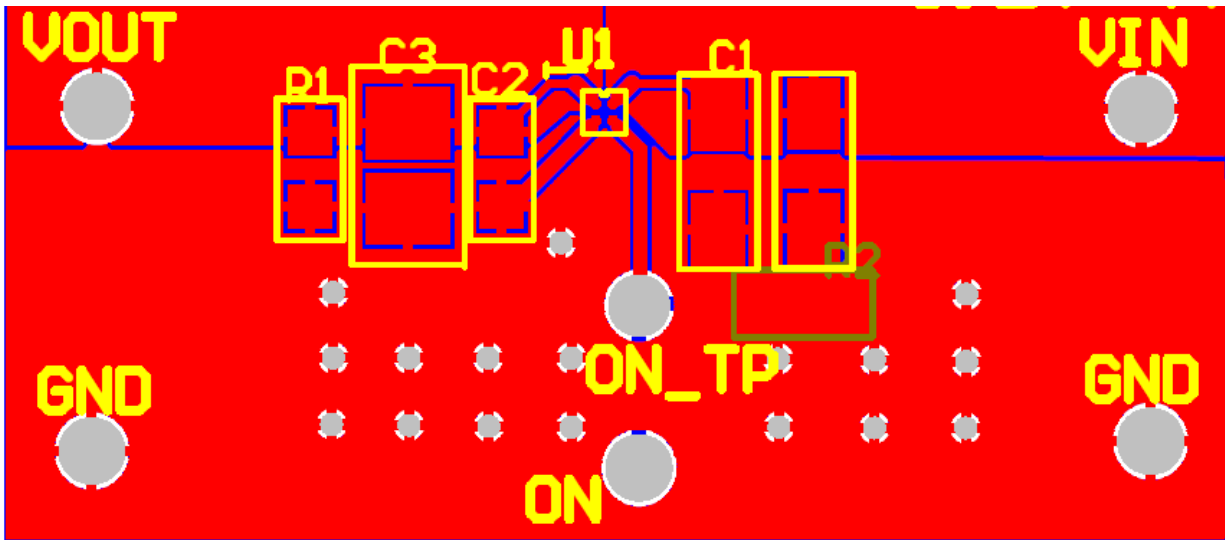
**WLCSP4 0.96x0.96x0.582**  
CASE 567RH  
ISSUE O

DATE 30 NOV 2016

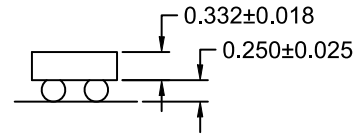
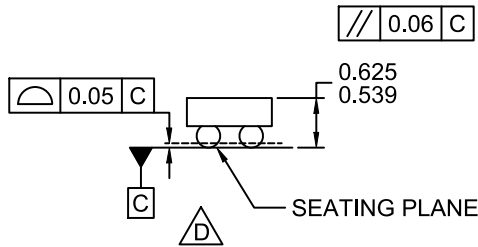
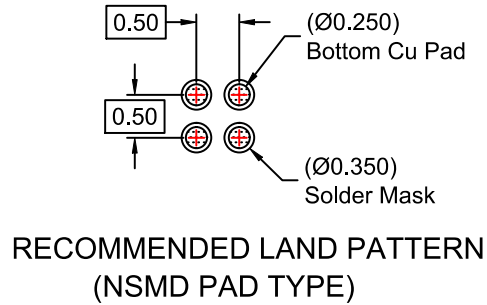
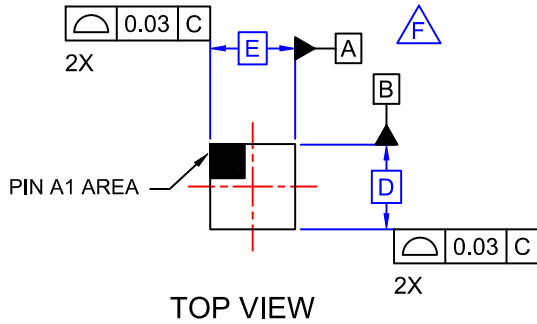

**SIDE VIEWS**

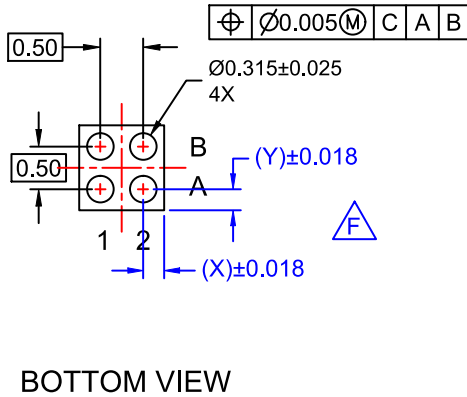

**NOTES:**

- A. NO JEDEC REGISTRATION APPLIES.
- B. DIMENSIONS ARE IN MILLIMETERS.
- C. DIMENSIONS AND TOLERANCES PER ASME Y14.5M, 2009.
- D.** DATUM C IS DEFINED BY THE SPHERICAL CROWNS OF THE BALLS.
- E. PACKAGE NOMINAL HEIGHT IS 582 MICRONS ±43 MICRONS (539-625 MICRONS).
- F.** FOR DIMENSIONS D, E, X, AND Y SEE PRODUCT DATASHEET.

<b>DOCUMENT NUMBER:</b>	<b>98AON16575G</b>	Electronic versions are uncontrolled except when accessed directly from the Document Repository. Printed versions are uncontrolled except when stamped "CONTROLLED COPY" in red.
<b>DESCRIPTION:</b>	<b>WLCSP4 0.96x0.96x0.582</b>	<b>PAGE 1 OF 1</b>

ON Semiconductor and **ON** are trademarks of Semiconductor Components Industries, LLC dba ON Semiconductor or its subsidiaries in the United States and/or other countries. ON Semiconductor reserves the right to make changes without further notice to any products herein. ON Semiconductor makes no warranty, representation or guarantee regarding the suitability of its products for any particular purpose, nor does ON Semiconductor assume any liability arising out of the application or use of any product or circuit, and specifically disclaims any and all liability, including without limitation special, consequential or incidental damages. ON Semiconductor does not convey any license under its patent rights nor the rights of others.

ON Semiconductor and  are trademarks of Semiconductor Components Industries, LLC dba ON Semiconductor or its subsidiaries in the United States and/or other countries. ON Semiconductor owns the rights to a number of patents, trademarks, copyrights, trade secrets, and other intellectual property. A listing of ON Semiconductor's product/patent coverage may be accessed at [www.onsemi.com/site/pdf/Patent-Marking.pdf](http://www.onsemi.com/site/pdf/Patent-Marking.pdf). ON Semiconductor reserves the right to make changes without further notice to any products herein. ON Semiconductor makes no warranty, representation or guarantee regarding the suitability of its products for any particular purpose, nor does ON Semiconductor assume any liability arising out of the application or use of any product or circuit, and specifically disclaims any and all liability, including without limitation special, consequential or incidental damages. Buyer is responsible for its products and applications using ON Semiconductor products, including compliance with all laws, regulations and safety requirements or standards, regardless of any support or applications information provided by ON Semiconductor. "Typical" parameters which may be provided in ON Semiconductor data sheets and/or specifications can and do vary in different applications and actual performance may vary over time. All operating parameters, including "Typicals" must be validated for each customer application by customer's technical experts. ON Semiconductor does not convey any license under its patent rights nor the rights of others. ON Semiconductor products are not designed, intended, or authorized for use as a critical component in life support systems or any FDA Class 3 medical devices or medical devices with a same or similar classification in a foreign jurisdiction or any devices intended for implantation in the human body. Should Buyer purchase or use ON Semiconductor products for any such unintended or unauthorized application, Buyer shall indemnify and hold ON Semiconductor and its officers, employees, subsidiaries, affiliates, and distributors harmless against all claims, costs, damages, and expenses, and reasonable attorney fees arising out of, directly or indirectly, any claim of personal injury or death associated with such unintended or unauthorized use, even if such claim alleges that ON Semiconductor was negligent regarding the design or manufacture of the part. ON Semiconductor is an Equal Opportunity/Affirmative Action Employer. This literature is subject to all applicable copyright laws and is not for resale in any manner.

## PUBLICATION ORDERING INFORMATION

### LITERATURE FULFILLMENT:

Email Requests to: [orderlit@onsemi.com](mailto:orderlit@onsemi.com)

ON Semiconductor Website: [www.onsemi.com](http://www.onsemi.com)

### TECHNICAL SUPPORT

North American Technical Support:  
Voice Mail: 1 800-282-9855 Toll Free USA/Canada  
Phone: 011 421 33 790 2910

Europe, Middle East and Africa Technical Support:

Phone: 00421 33 790 2910

For additional information, please contact your local Sales Representative