



SGM2015

Low Power, Low Dropout, 250mA, RF -Linear Regulators

GENERAL DESCRIPTION

The SGM2015 series low-power, low-noise, low-dropout, CMOS linear voltage regulators operate from a 2.5V to 5.5V input and deliver up to 250mA. They are the perfect choice for low voltage, low power applications. An ultra low ground current (160 μ A at 250mA output) makes these part attractive for battery operated power systems. The SGM2015 series also offer ultra low dropout voltage (250mV at 250mA output) to prolong battery life in portable electronics. Systems requiring a quiet voltage source, such as RF applications, will benefit from the SGM2015 series' ultra low output noise (30 μ V_{RMS}) and high PSRR. An external noise bypass capacitor connected to the device's BP pin can further reduce the noise level.

The output voltage is preset to voltages in the range of 1.5V to 3.3V. Other features include a 10nA logic-controlled shutdown mode, foldback current limit and thermal shut- down protection.

Devices come in 5-pin SOT23 package.

APPLICATIONS

Cellular Telephones
Cordless Telephones
PHS Telephones
PCMCIA Cards
Modems
MP3 Player
Hand-Held Instruments
Palmtop Computers
Electronic Planners
Portable/Battery-Powered Equipment

FEATURES

- Low Output Noise: 30 μ V_{RMS} TYP (10Hz to 100kHz)
- Ultra-Low Dropout Voltage:
250mV at 250mA Output
- Low 85 μ A No-Load Supply Current
- Low 160 μ A Operating Supply Current
at 250mA Output
- High PSRR (73dB at 1kHz)
- Thermal-Overload Protection
- Output Current Limit
- 10nA Logic-Controlled Shutdown
- Available in Multiple Output Voltage Versions
Fixed Outputs of 1.5V, 1.8V, 2.5V, 2.8V, 2.85V,
3.0V, 3.3V

PIN CONFIGURATION (TOP VIEW)

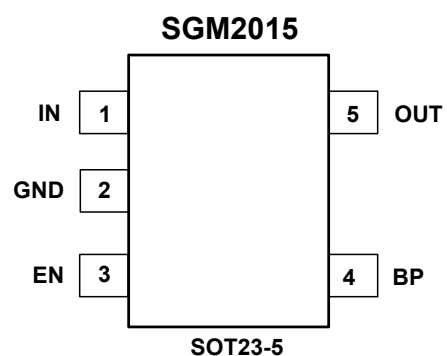

PACKAGE/ORDERING INFORMATION

MODEL	V _{OUT} (V)	PIN-PACKAGE	SPECIFIED TEMPERATURE RANGE	ORDERING NUMBER	PACKAGE MARKING	PACKAGE OPTION
SGM2015-1.5	1.5V	SOT23-5	- 40°C to +85°C	SGM2015-1.5YN5/TR	YF15	Tape and Reel, 3000
SGM2015-1.8	1.8V	SOT23-5	- 40°C to +85°C	SGM2015-1.8YN5/TR	YF18	Tape and Reel, 3000
SGM2015-2.5	2.5V	SOT23-5	- 40°C to +85°C	SGM2015-2.5YN5/TR	YF25	Tape and Reel, 3000
SGM2015-2.8	2.8V	SOT23-5	- 40°C to +85°C	SGM2015-2.8YN5/TR	YF28	Tape and Reel, 3000
SGM2015-2.85	2.85V	SOT23-5	- 40°C to +85°C	SGM2015-2.85YN5/TR	YF2J	Tape and Reel, 3000
SGM2015-3.0	3.0V	SOT23-5	- 40°C to +85°C	SGM2015-3.0YN5/TR	YF30	Tape and Reel, 3000
SGM2015-3.3	3.3V	SOT23-5	- 40°C to +85°C	SGM2015-3.3YN5/TR	YF33	Tape and Reel, 3000

ABSOLUTE MAXIMUM RATINGS

IN to GND.....- 0.3V to 6V
 Output Short-Circuit DurationInfinite
 EN to GND.....- 0.3V to V_{IN}
 OUT, BP/FB to GND.....- 0.3V to (V_{IN} + 0.3V)
 Power Dissipation, P_D @ T_A = 25°C
 SOT23-50.4W
 Package Thermal Resistance
 SOT23-5, θ_{JA}..... 250°C/W

Operating Temperature Range.....- 40°C to +85°C
 Junction Temperature.....150°C
 Storage Temperature.....- 65°C to +150°C
 Lead Temperature (soldering, 10s).....260°C
 ESD Susceptibility
 HBM.....4000V
 MM.....400V

Stresses beyond those listed under “Absolute Maximum Ratings” may cause permanent damage to the device. These are stress ratings only, and functional operation of the device at these or any other conditions beyond those indicated in the operational sections of the specifications is not implied. Exposure to absolute maximum rating conditions for extended periods may affect device reliability.

CAUTION

This integrated circuit can be damaged by ESD if you don't pay attention to ESD protection. SGMICRO recommends that all integrated circuits be handled with appropriate precautions. Failure to observe proper handling and installation procedures can cause damage.

ESD damage can range from subtle performance degradation to complete device failure. Precision integrated circuits may be more susceptible to damage because very small parametric changes could cause the device not to meet its published specifications.

ELECTRICAL CHARACTERISTICS

$V_{IN} = V_{OUT(NOMINAL)} + 1V$, $T_A = -40^{\circ}C$ to $+85^{\circ}C$. Typical values are at $T_A = +25^{\circ}C$, unless otherwise noted.

PARAMETER	SYMBOL	CONDITIONS	MIN	TYP	MAX	UNITS
Input Voltage	V_{IN}		2.5		5.5	V
Output Voltage Accuracy		$I_{OUT} = 0.1mA$, $T_A = +25^{\circ}C$	-2		2	%
		$I_{OUT} = 0.1mA$ to $250mA$ $T_A = -40^{\circ}C$ to $+85^{\circ}C$			2.6	
Maximum Output Current			250			mA
Current Limit	I_{LIM}		260	450		mA
Ground Pin Current	I_Q	No load, $EN = 1.6V$		85	135	μA
		$I_{OUT} = 250mA$, $EN = 1.6V$		160		
Dropout Voltage (Note1)		$I_{OUT} = 1mA$		1.2		mV
		$I_{OUT} = 250mA$		250	400	
Line Regulation	ΔV_{LNR}	$V_{IN} = 2.5V$ or $(V_{OUT} + 0.5V)$ to $5.5V$ $I_{OUT} = 1mA$		0.015	0.15	%/V
Load Regulation	ΔV_{LDR}	$I_{OUT} = 0.1mA$ to $250mA$, $C_{OUT} = 1\mu F$		0.001	0.003	%/mA
Output Voltage Noise	e_n	$f = 10Hz$ to $100kHz$, $C_{BP} = 0.01\mu F$, $C_{OUT} = 10\mu F$		30		μV_{RMS}
Power Supply Rejection Rate	PSRR	$C_{BP} = 0.1\mu F$, $I_{LOAD} = 50mA$ $C_{OUT} = 1\mu F$	$f = 100Hz$	76		dB
			$f = 1kHz$	73		dB
SHUTDOWN						
EN Input Threshold	V_{IH}	$V_{IN} = 2.5V$ to $5.5V$	1.6			V
	V_{IL}				0.4	
EN Input Bias Current	$I_{B(SHDN)}$	$EN = 0V$ and $EN = 5.5V$	$T_A = +25^{\circ}C$	0.01	1	μA
			$T_A = +125^{\circ}C$	0.01		
Shutdown Supply Current	$I_{Q(SHDN)}$	$EN = 0.4V$	$T_A = +25^{\circ}C$	0.01	1	μA
			$T_A = +125^{\circ}C$	0.01		
Shutdown Exit Delay (Note2)		$C_{BP} = 0.01\mu F$ $C_{OUT} = 1\mu F$, No load	$T_A = +25^{\circ}C$	30		μs
THERMAL PROTECTION						
Thermal Shutdown Temperature	T_{SHDN}			160		$^{\circ}C$
Thermal Shutdown Hysteresis	ΔT_{SHDN}			10		$^{\circ}C$

Specifications subject to change without notice.

Note 1: The dropout voltage is defined as $V_{IN} - V_{OUT}$, when V_{OUT} is 100mV below the value of V_{OUT} for $V_{IN} = V_{OUT} + 1V$. (Only applicable for $V_{OUT} = +2.5V$ to $+3.3V$)

Note 2: Time needed for V_{OUT} to reach 95% of final value.

TYPICAL OPERATION CIRCUIT

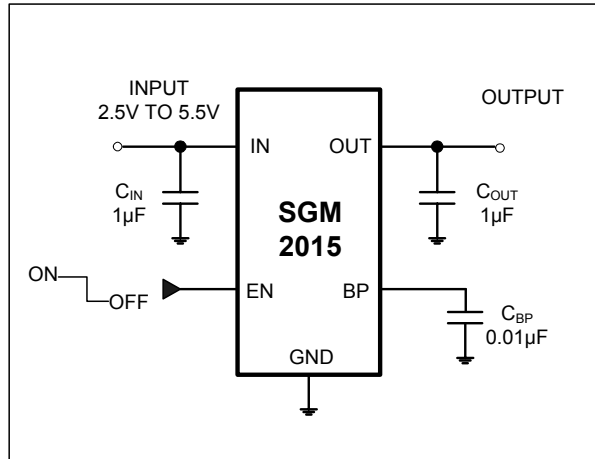

PIN DESCRIPTION

PIN	NAME	FUNCTION
1	IN	Regulator Input. Supply voltage can range from 2.5V to 5.5V. Bypass with a 1µF capacitor to GND.
2	GND	Ground.
3	EN	Shutdown Input. A logic low reduces the supply current to 10nA. Connect to IN for normal operation.
4	BP	Reference-Noise Bypass. Bypass with a low-leakage 0.01µF ceramic capacitor for reduced noise at the output.
5	OUT	Regulator Output.

TYPICAL OPERATING CHARACTERISTICS

$V_{IN} = V_{OUT(NOMINAL)} + 1V$, $C_{IN} = 1\mu F$, $C_{OUT} = 1\mu F$, $C_{BP} = 0.01\mu F$, $T_A = +25^\circ C$, unless otherwise noted.

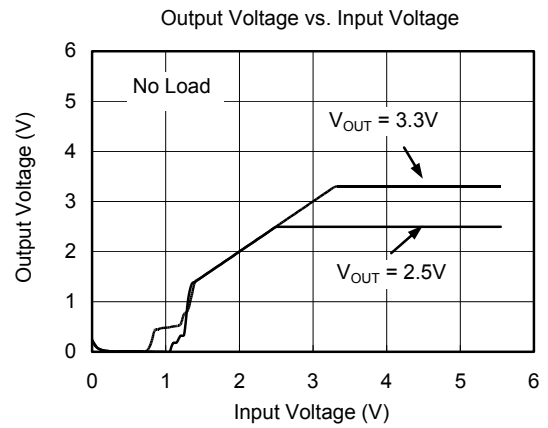
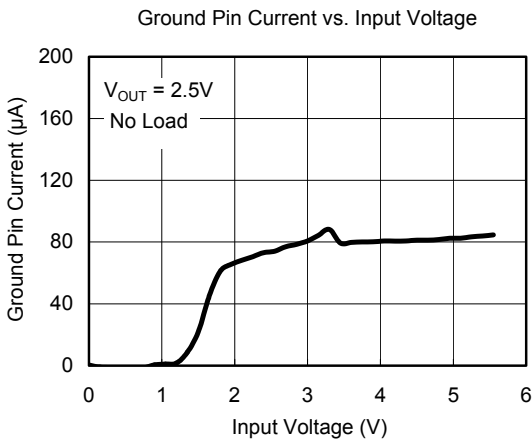
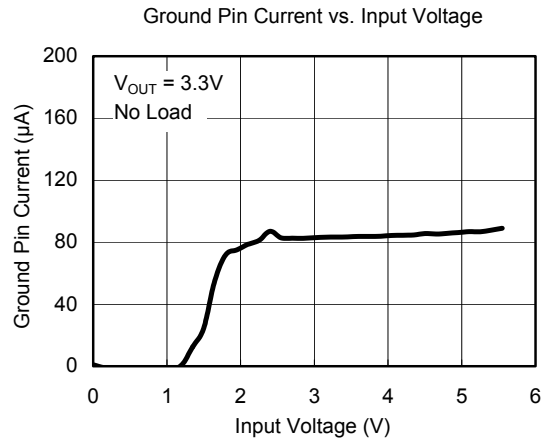
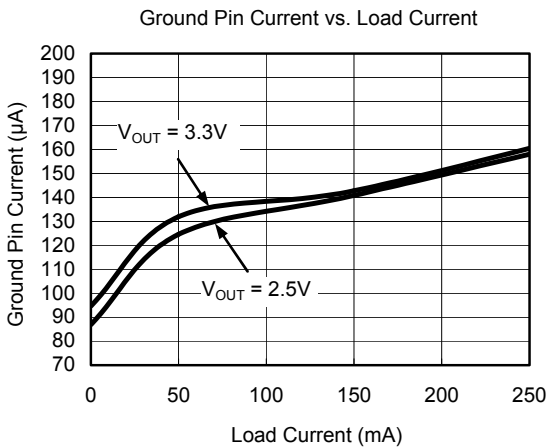
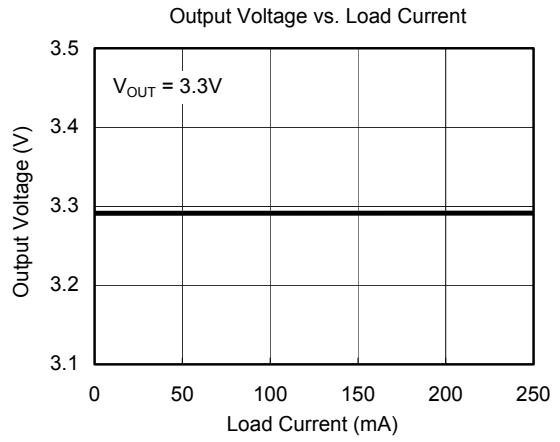
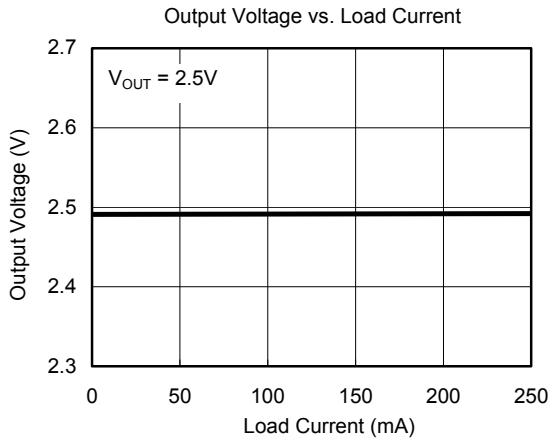

TYPICAL OPERATING CHARACTERISTICS

$V_{IN} = V_{OUT(NOMINAL)} + 1V$, $C_{IN} = 1\mu F$, $C_{OUT} = 1\mu F$, $C_{BP} = 0.01\mu F$, $T_A = +25^\circ C$, unless otherwise noted.

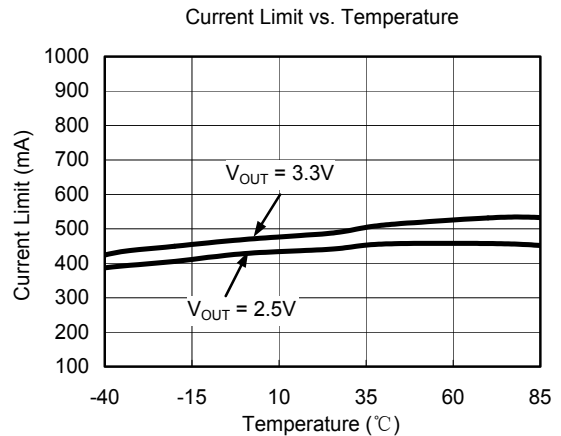
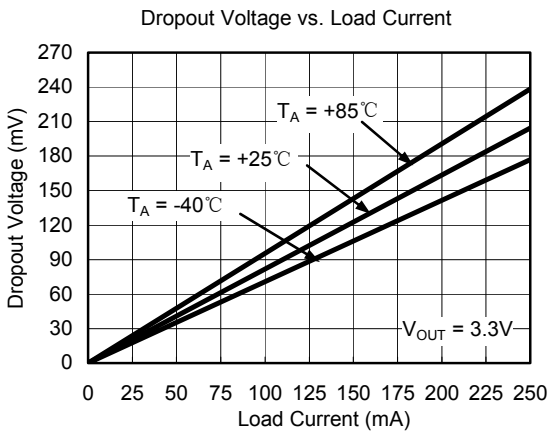
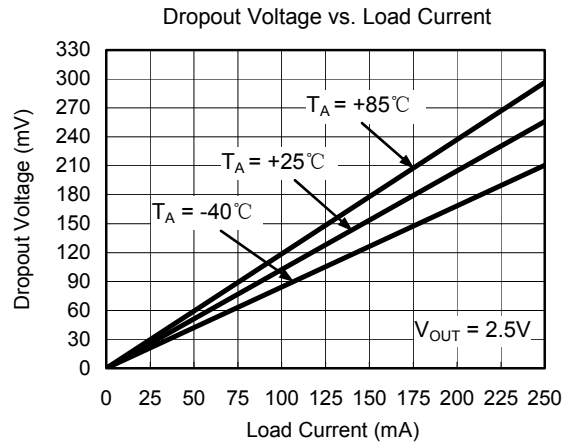
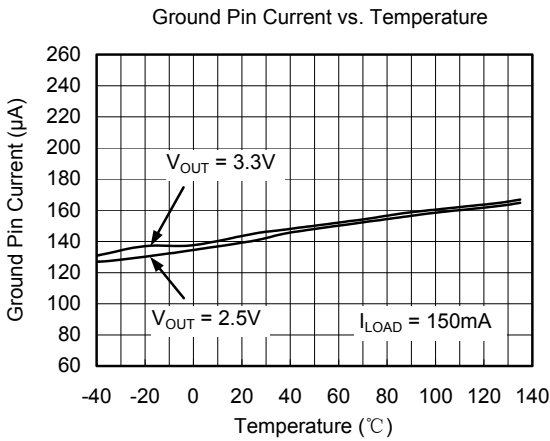
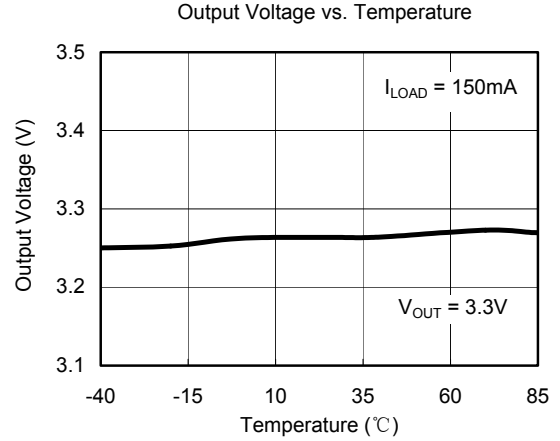
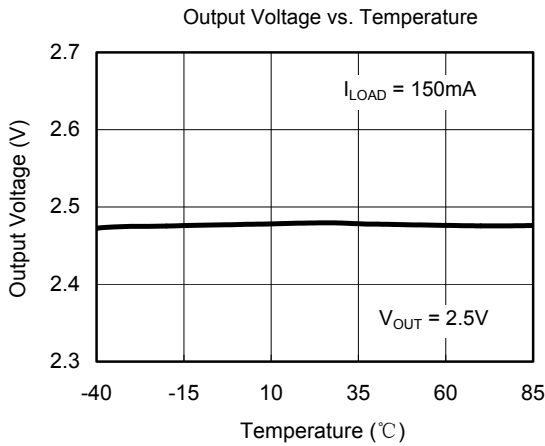

TYPICAL OPERATING CHARACTERISTICS

$V_{IN} = V_{OUT(NOMINAL)} + 1V$, $C_{IN} = 1\mu F$, $C_{OUT} = 1\mu F$, $C_{BP} = 0.01\mu F$, $T_A = +25^\circ C$, unless otherwise noted.

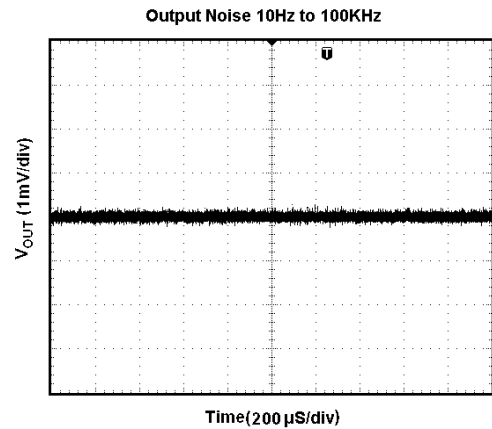
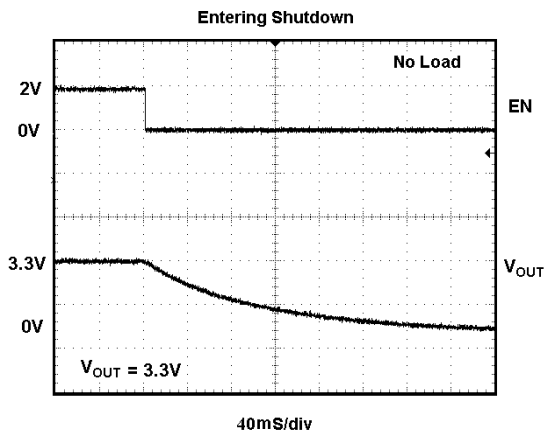
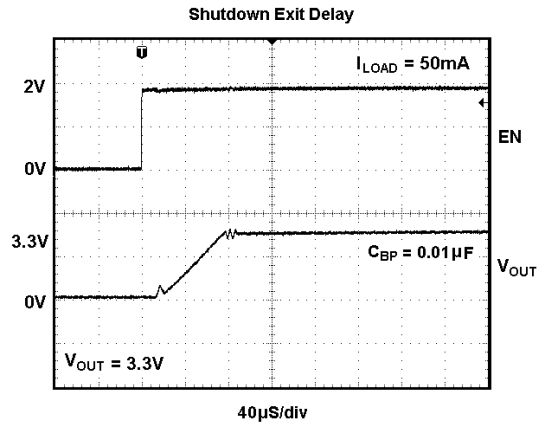
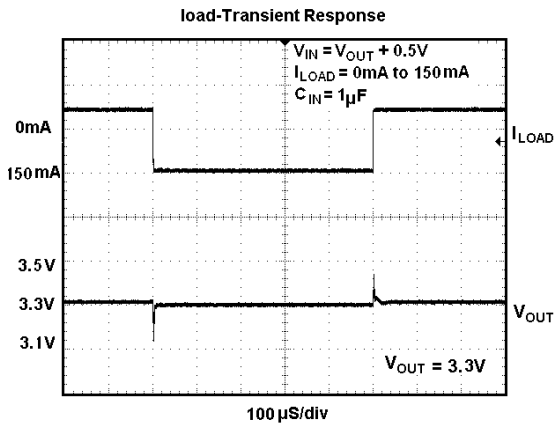
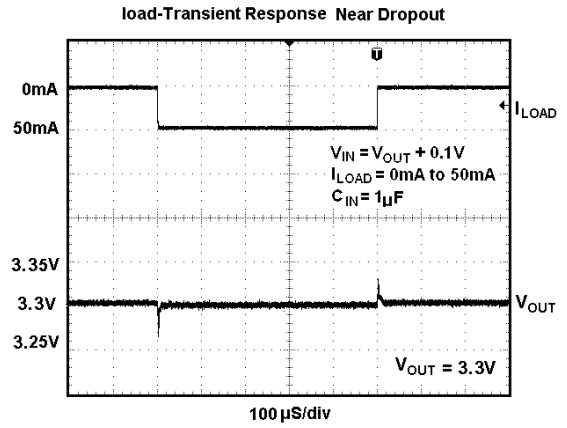
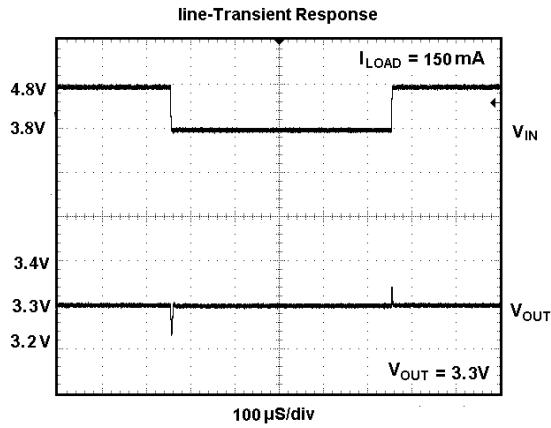

TYPICAL OPERATING CHARACTERISTICS

$V_{IN} = V_{OUT(NOMINAL)} + 1V$, $C_{IN} = 1\mu F$, $C_{OUT} = 1\mu F$, $C_{BP} = 0.01\mu F$, $T_A = +25^\circ C$, unless otherwise noted.

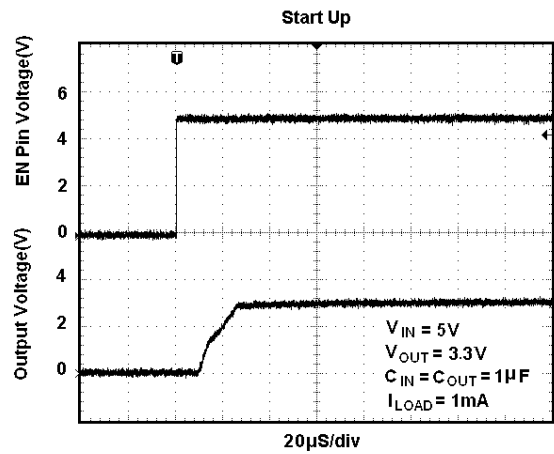
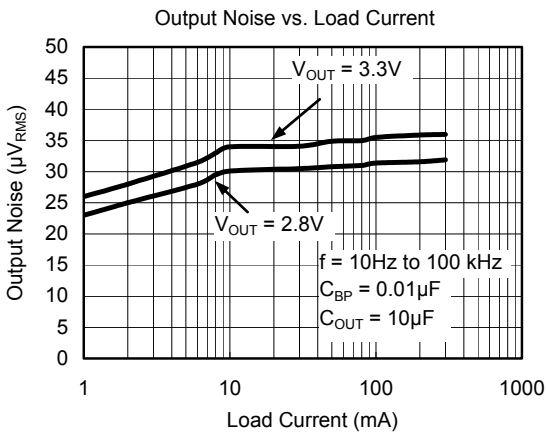
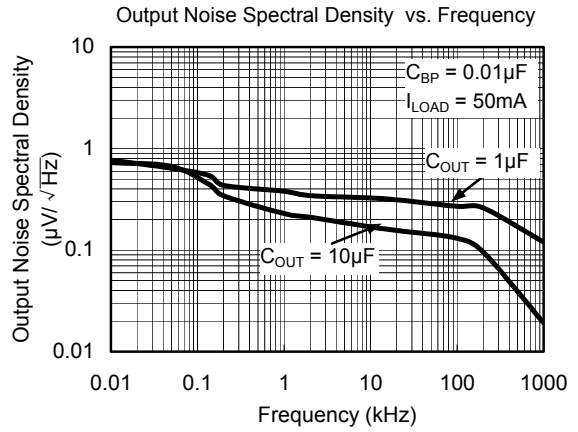
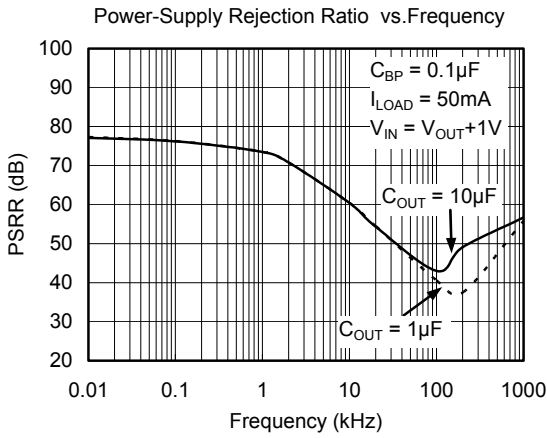

APPLICATION NOTES

When LDO is used in handheld products, attention must be paid to voltage spikes which could damage SGM2015. In such applications, voltage spikes will be generated at charger interface and V_{BUS} pin of USB interface when charger adapters and USB equipments are hot-plugged. Besides this, handheld products will be tested on the production line without battery. Test engineer will apply power from the connector pin which connects with positive pole of the battery. When external power supply is turned on suddenly, the voltage spikes will be generated at the battery connector. The voltage spikes will be very high, and it always exceeds the absolute maximum input voltage (6.0V) of LDO. In order to get robust design, design engineer needs to clear up this voltage spike. Zener diode is a cheap and effective solution to eliminate such voltage spike. For example, BZM55B5V6 is a 5.6V small package Zener diode which can be used to remove voltage spikes in cell phone designs. The schematic is shown below.

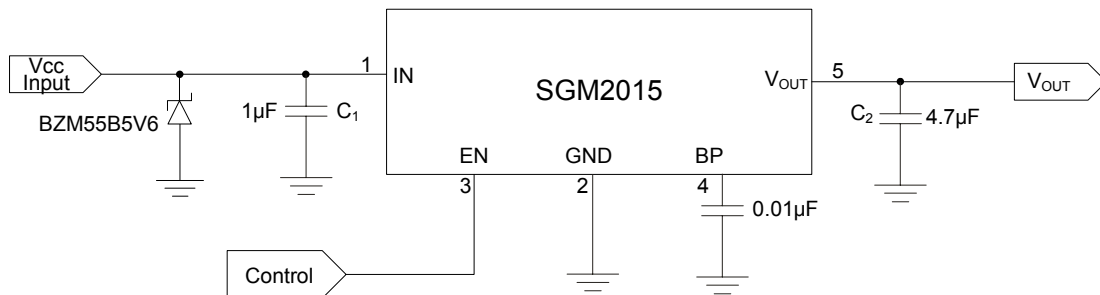

PACKAGE OUTLINE DIMENSIONS

SOT23-5

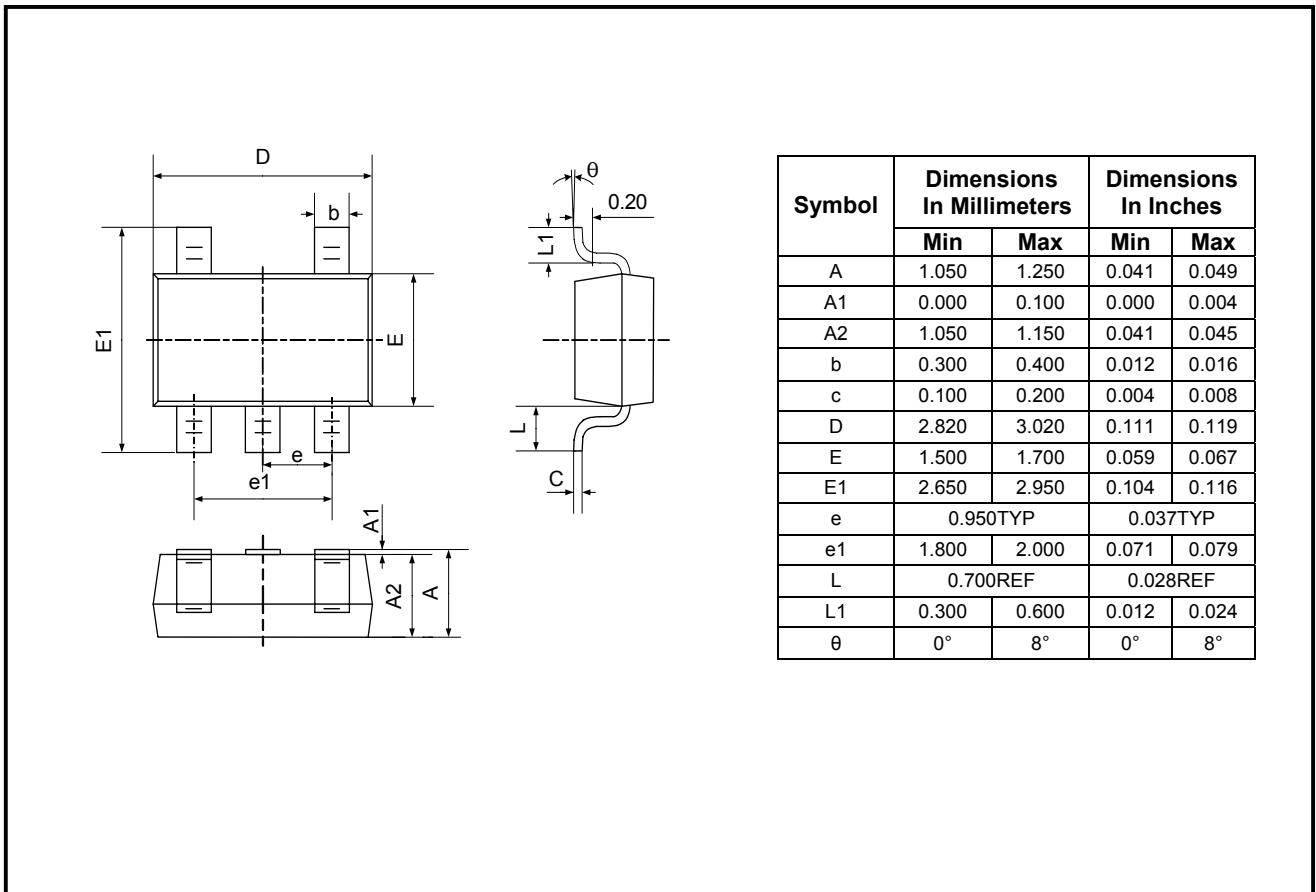

01/2009 REV. A. 1

SGMICRO is dedicated to provide high quality and high performance analog IC products to customers. All SGMICRO products meet the highest industry standards with strict and comprehensive test and quality control systems to achieve world-class consistency and reliability.

For information regarding SGMICRO Corporation and its products, see www.sg-micro.com