

# 3A High Current, Low Dropout Voltage Regulator

*Adjustable & Fixed Output, Fast Response Time*

## FEATURES

- Adjustable Output Down To 1.25V
- 1% Output Accuracy
- Output Current of 3A
- Low Dropout Voltage of 550mV @ 3A
- Extremely Tight Load and Line Regulation
- Extremely Fast Transient Response
- Reverse-Battery Protection
- Zero Current Shutdown (5 pin version)
- Error Flag Signal Output for Out of Regulation State (5 pin version)
- Standard TO-220 and TO-263 Packages

## APPLICATIONS

- Powering VGA & Sound Card
- Power PC™ Supplies
- SMPS Post Regulator
- High Efficiency “Green” Computer Systems
- High Efficiency Linear Power Supplies
- Constant Current Regulators
- Adjustable Power Supplies
- Battery Charger

## DESCRIPTION

The SPX29300/01/02/03 are 3A, highly accurate voltage regulators with a low drop out voltage of 550mV dropout (typical) @ 3A. These regulators are specifically designed for low voltage applications that require a low dropout voltage and a fast transient response. They are fully fault protected against over-current, reverse battery, and positive and negative voltage transients. On-Chip trimming adjusts the reference voltage to 1% initial accuracy. Other features in the 5 pin versions include Enable, and Error Flag.

The SPX29300/01/02/03 are offered in 3 & 5-pin TO-220 & TO-263 packages. For a 1.5A version, refer to the SPX29150 data sheet.

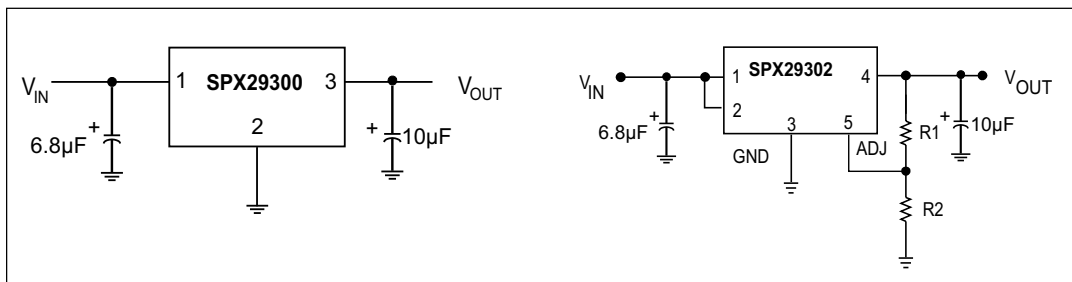

**Figure 1. Fixed Output Linear Regulator**

**Figure 2. Adjustable Output Linear Regulator**

## ABSOLUTE MAXIMUM RATINGS

Lead Temperature (soldering, 5 seconds) .....260°C  
 Storage Temperature Range.....-65°C to +150°C  
 Operating Junction Temperature Range.....-40°C to +125°C  
 Input Voltage (Note 7) ..... 16V

## ELECTRICAL CHARACTERISTICS

(Note 1) at  $V_{IN}=V_{OUT} + 1V$  and  $I_{OUT} = 10mA$ ,  $C_{IN} = 6.8\mu F$ ,  $C_{OUT} = 10\mu F$ ,  $T_A = 25^\circ C$ , unless otherwise specified. The Boldface applies over the junction temperature range.

SPX29300/01					
PARAMETER	CONDITIONS	TYP	MIN	MAX	UNITS
<b>Fixed Voltage Options</b>					
<b>1.8V Version</b>					
Output Voltage	$I_{OUT} = 10mA$ $10mA \leq I_{OUT} \leq 3A$ , $2.8V \leq V_{IN} \leq 16V$	1.800 <b>1.800</b>	1.782 <b>1.764</b>	1.818 <b>1.836</b>	V
<b>2.5V Version</b>					
Output Voltage	$I_{OUT} = 10mA$ $10mA \leq I_{OUT} \leq 3A$ , $3.5V \leq V_{IN} \leq 16V$	2.500 <b>2.500</b>	2.475 <b>2.450</b>	2.525 <b>2.550</b>	V
<b>3.3V Version</b>					
Output Voltage	$I_{OUT} = 10mA$ $10mA \leq I_{OUT} \leq 3A$ , $4.3V \leq V_{IN} \leq 16V$	3.300 <b>3.300</b>	3.267 <b>3.234</b>	3.333 <b>3.366</b>	V
<b>5.0V Version</b>					
Output Voltage	$I_{OUT} = 10mA$ $10mA \leq I_{OUT} \leq 3A$ , $6.0V \leq V_{IN} \leq 16V$	5.000 <b>5.000</b>	4.950 <b>4.900</b>	5.050 <b>5.100</b>	V
<b>All Voltage Options</b>					
SPX29300/01/02/03					
Line Regulation	$I_{OUT}=10mA, (V_{OUT}+1V) \leq V_{IN} \leq 16V$			0.5	%
Load Regulation	$V_{IN}=V_{OUT}+1V$ , $10mA \leq I_{OUT} \leq I_{FL}$ (Note 2)	0.2		1	%
$\Delta V/\Delta T$	$V_{OUT}$ Temp Coefficient (Note 6)	<b>20</b>		<b>100</b>	ppm/°C
Dropout Voltage, except 1.8V, (Note 3)	$I_{OUT}=100mA$ $I_{OUT}=1.5A$ $I_{OUT}=3.0A$	50 250 550		<b>175</b> <b>750</b>	mV
Ground Current (Note 5)	$I_{OUT}=1.5A$ $I_{OUT}=3.0A$	16 66		<b>55</b>	mA
Ground Pin Current at Dropout	$V_{IN}=0.5V$ less than specified $V_{OUT}$ , $I_{OUT}=10mA$	0.9			mA
Current Limit	$V_{OUT}=0V$ (Note 4)	4.5	3.0		A
Output Noise Voltage (10Hz to 100kHz) $I_L=100mA$	$C_L=10\mu F$ $C_L=33\mu F$	400 260			$\mu V_{RMS}$
Reference Voltage	Adjustable version only	1.240	1.228 <b>1.215</b>	1.252 <b>1.265</b>	V
Reference Voltage	Adjustable version only (Note 8)		1.203	1.277	V
Adjust Pin Bias Current		40		80 <b>120</b>	nA
Reference Voltage Temp. Coeff.	(Note 7)	20			ppm/°C
Adjust Pin Bias Current Temp. Coeff.		0.1			nA/°C

# ELECTRICAL CHARACTERISTICS

at  $V_{IN} = V_{OUT} + 1V$  and  $I_{OUT} = 10mA$ ,  $C_{IN} = 6.8\mu F$ ,  $C_{OUT} = 10\mu F$ ,  $T_A = 25^\circ C$ , unless otherwise specified. The Boldface applies over the junction temperature range. Adjustable versions are set to 5.0V.

PARAMETER	CONDITIONS	TYP	MIN	MAX	UNITS
<b>FLAG OUTPUT (ERROR COMPARATOR)</b>		<b>SPX29301/03</b>			
Output Leakage Current	$V_{OH} = 16V$	0.01		1 2	$\mu A$
Output Low Voltage	Device set for 5V, $V_{IN} = 4.5V$ , $I_{OL} = 250\mu A$	220		300 400	mV
Upper Threshold Voltage	Device set for 5V, (Note 9)	60	40 25		mV
Lower Threshold Voltage	Device set for 5V, (Note 9)	75		95 140	mV
Hysteresis	Device set for 5V, (Note 9)	15			mV
<b>ENABLE Input</b>		<b>SPX29301/02</b>			
Input Logic Voltage Low (OFF) High (ON)	$V_{IN} < 10V$		2.4	0.8	V
ENABLE Input Pin	$V_{EN} = 16V$  $V_{EN} = 0.8V$	100		600 750 1 2	$\mu A$  $\mu A$
Regulator Output Current in Shutdown	(Note 10)	10		500	$\mu A$
Thermal Resistance	TO-200 Junction to Case, at Tab TO-220 Junction to Ambient TO-263 Junction to Case, at Tab TO-263 Junction to Ambient	3 60 3 60			$^\circ C/W$

**NOTES:**

- Note 1: Maximum positive supply voltage of 20V must be of limited duration ( $<100m_s$ )  $< 1\%$ . The maximum continuous supply voltage is 16V.
- Note 2: Full load current ( $I_{FL}$ ) is defined as 3.0A.
- Note 3: Dropout voltage is defined as the input to output differential when the output voltage drops to 99% of its nominal value.
- Note 4:  $V_{IN} = V_{OUT} (NOMINAL) + 1V$ . For example, use  $V_{IN} = 4.3V$  for a 3.3V regulator. Employ pulse-testing procedures to minimize temperature rise.
- Note 5: Ground pin current is the regulator quiescent current. The total current drawn from the source is the sum of the load current to the ground current.
- Note 6: Output voltage temperature coefficient is defined as the worst case voltage change divided by the total temperature range
- Note 7: Thermal regulation is defined as the change in output voltage at time T after a change in power dissipation is applied, excluding load / line regulation effects. Specifications for a 200mA load pulse as  $V_{IN} = 20V$  (a 4W pulse) for  $t = 10ms$ .
- Note 8:  $V_{REF} \leq V_{OUT} \leq (V_{IN} - 1)$ ,  $2.3V \leq V_{IN} \leq 16V$ ,  $10mA \leq I_L \leq I_{FL}$ ,  $T_j < T_{jmax}$ .
- Note 9: Comparator threshold is expressed in terms of a voltage differential at the Adjust terminal below the nominal reference voltage measured 6V input. To express these thresholds in terms of output voltage change, multiply the error amplifier gain =  $V_{OUT}/V_{REF} = (R1 + R2)/R2$ . For example, at a programmable output voltage of 5V, the Error output is guaranteed to go low when the output drops by  $95mV \times 5V / 1.240V = 38mV$ . Threshold remain constant as a percent of  $V_{OUT}$  as  $V_{OUT}$  is varied, with the dropout warning occurring at typically 5% below nominal, 7.7% guaranteed.
- Note 10:  $V_{EN} \leq 0.8V$  and  $V_{IN} \leq 16V$ ,  $V_{OUT} = 0$ .

## BLOCK DIAGRAM

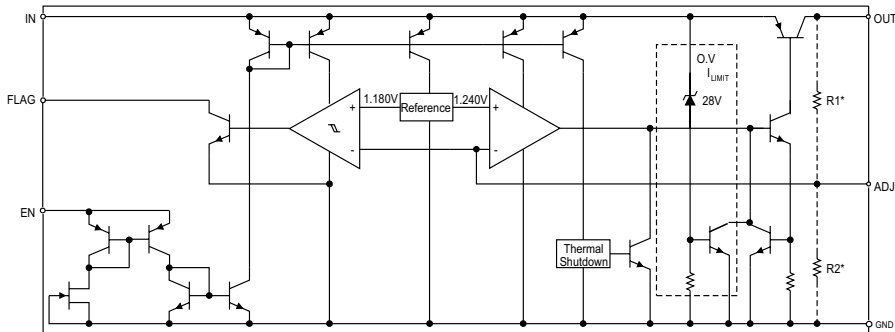

# TYPICAL PERFORMANCE CHARACTERISTICS

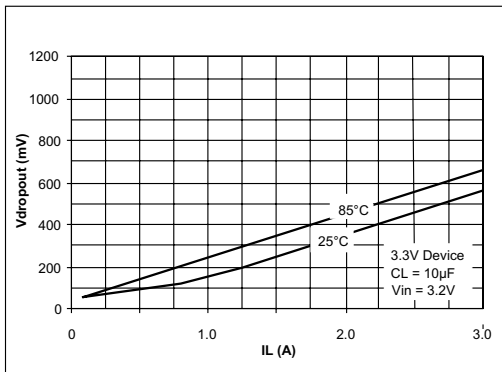

Figure 3. Dropout Voltage vs Load Current

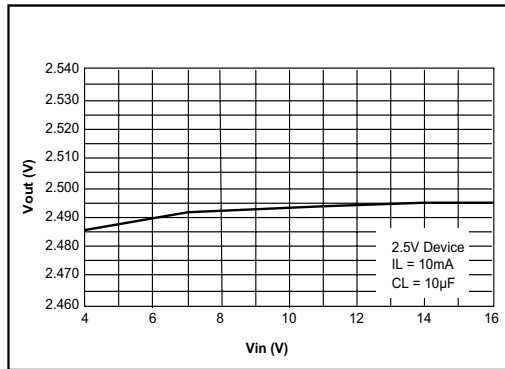

Figure 4. Line Regulation

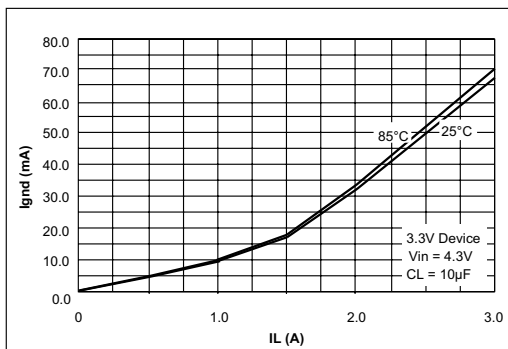

Figure 5. Ground Current vs Load Current

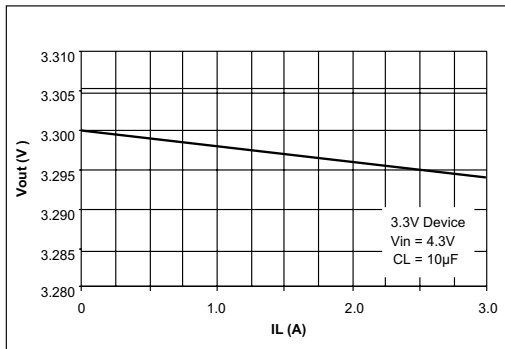

Figure 6. Load Regulation

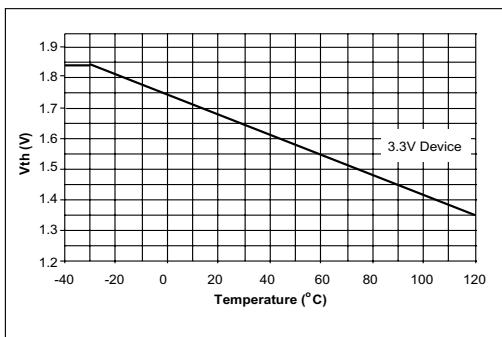

Figure 7. Enable Threshold vs Temperature

## APPLICATION INFORMATION

The SPX29300/01/02/03 incorporates protection against over-current faults, reversed load insertion, over temperature operation, and positive and negative transient voltage.

### Thermal Considerations

Although the SPX29300/01/02/03 offers limiting circuitry for overload conditions, it is still necessary to insure that the maximum junction temperature is not exceeded in the application. Heat will flow through the lowest resistance path, the junction-to-case path. In order to insure the best thermal flow of the component, proper mounting is required.

### TO-220 Design Example:

Assume that  $V_{IN} = 10V$ ,  $V_{OUT} = 5V$ ,  $I_{OUT} = 1.5A$ ,  $T_A = 50^{\circ}C$ ,  $\theta_{HA} = 1^{\circ}C/W$ ,  $\theta_{CH} = 2^{\circ}C/W$ , and  $\theta_{JC} = 3^{\circ}C/W$ , where:

- $T_A$  = ambient temperature,
- $\theta_{HA}$  = heatsink to ambient thermal resistance
- $\theta_{CH}$  = case to heatsink thermal resistance
- $\theta_{JC}$  = junction to case thermal resistance

The power calculated under these conditions is:

$$P_D = (V_{IN} - V_{OUT}) * I_{OUT} = 7.5W.$$

And the junction temperature is calculated as

$$T_J = T_A + P_D * (\theta_{HA} + \theta_{CH} + \theta_{JC}) \text{ or}$$
$$T_J = 50 + 7.5 * (1+2+3) = 95^{\circ}C$$

Reliable operation is insured.

### Capacitor Requirements

The output capacitor is needed to insure stability and minimize the output noise. The value of the capacitor varies with the load. However, a minimum value of 10 $\mu$ F aluminum capacitor will guarantee stability over all load conditions. A tantalum capacitor is recommended if a faster load transient

response is needed. If the power source has a high AC impedance, a 0.1 $\mu$ F ceramic capacitor between input & ground is recommended.

### Minimum Load Current

To ensure a proper behavior of the regulator under light load, a minimum load of 5mA for SPX29300/01/02/03 is required.

### Adjustable Regulator Design

The SPX29302/03 are adjustable regulators that can be programmed to any value between 1.25V and 16V using 2 resistors, R1 and R2. The relationship between the resistors is:

$$R1 = R2(V_{out}/1.240-1).$$

### Error Flag

The SPX29301/03 features an error flag that indicates either an over current or under voltage condition. The flag output goes low, sinking 10mA when either condition occurs.

### Enable Input

The SPX29301/02 have an Enable function that switches the regulator on and off. Their thresholds are TTL compatible. When the regulator is active, approximately 20 uA flows through the Enable pin.

### Typical Application Circuits

Figure 1 represents a typical fixed output regulator. Figure 2 represents an adjustable output regulator. The values of R1 and R2 set the output voltage value as follows:

$$V_{OUT} = V_{REF} * [1 + (R1/R2)].$$

For best results, the total series resistance should be small enough to pass a minimum regulator load current of 5 mA. A minimum value of 10kohms is recommended for R2 with a range between 10kohms and 47 kohms.

# PACKAGES

TO-263-3 Package (T)

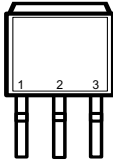

$V_{IN}$  GND  $V_{OUT}$   
Front View

TO-263-5 Package (T5)

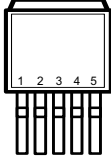

Top View

**SPX29301**  
1)ENABLE  
2)INPUT  
3)GND  
4)OUTPUT  
5)FLAG

**SPX29302**  
1) ENABLE  
2) INPUT  
3) GND  
4) OUTPUT  
5) ADJUST

**SPX29303**  
1)FLAG  
2)INPUT  
3)GND  
4)OUTPUT  
5)ADJUST

TO-220-3 Package (U)

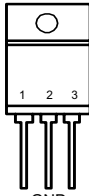

$V_{IN}$  GND  $V_{OUT}$   
Front View

TO-220-5 Package (U5)

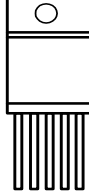

1 2 3 4 5  
Top View

**SPX29301**  
1)ENABLE  
2)INPUT  
3)GND  
4)OUTPUT  
5)FLAG

**SPX29302**  
1) ENABLE  
2) INPUT  
3) GND  
4) OUTPUT  
5) ADJUST

**SPX29303**  
1)FLAG  
2)INPUT  
3)GND  
4)OUTPUT  
5)ADJUST

\*Tab is internally connected to GND

## ORDERING INFORMATION

PART NUMBER	ACCURACY	OUTPUT VOLTAGE	PACKAGE
SPX29300U-1.8	1.0%	1.8V	3 lead TO-220
SPX29300U-2.5	1.0%	2.5V	3 lead TO-220
SPX29300U-3.3	1.0%	3.3V	3 lead TO-220
SPX29300U-5.0	1.0%	5.0V	3 lead TO-220
SPX29300T-1.8	1.0%	1.8V	3 lead TO-263
SPX29300T-2.5	1.0%	2.5V	3 lead TO-263
SPX29300T-3.3	1.0%	3.3V	3 lead TO-263
SPX29300T-5.0	1.0%	5.0V	3 lead TO-263
SPX29301U5-1.8	1.0%	1.8V	5 lead TO-220
SPX29301U5-2.5	1.0%	2.5V	5 lead TO-220
SPX29301U5-3.3	1.0%	3.3V	5 lead TO-220
SPX29301U5-5.0	1.0%	5.0V	5 lead TO-220
SPX29301T5-1.8	1.0%	1.8V	5 lead TO-263
SPX29301T5-2.5	1.0%	2.5V	5 lead TO-263
SPX29301T5-3.3	1.0%	3.3V	5 lead TO-263
SPX29301T5-5.0	1.0%	5.0V	5 lead TO-263
SPX29302T5	1.0%	Adj	5 lead TO-263
SPX29302U5	1.0%	Adj	5 lead TO-220
SPX29303T5	1.0%	Adj	5 lead TO-263
SPX29303U5	1.0%	Adj	5 lead TO-220

Please consult the factory for pricing and availability on a Tape-On-Reel option.



SIGNAL PROCESSING EXCELLENCE

**Sipex Corporation**

**Headquarters and  
Sales Office**

22 Linnell Circle  
Billerica, MA 01821  
TEL: (978) 667-8700  
FAX: (978) 670-9001  
e-mail: sales@sipex.com

**Sales Office**

233 South Hillview Drive  
Milpitas, CA 95035  
TEL: (408) 934-7500  
FAX: (408) 935-7600

Sipex Corporation reserves the right to make changes to any products described herein. Sipex does not assume any liability arising out of the application or use of any product or circuit described herein; neither does it convey any license under its patent rights nor the rights of others.