

Rail-to-rail high-speed comparator

Features

- Propagation delay: 8 ns
- Low current consumption: 470 μ A typ at 5 V
- Rail-to-rail inputs
- Push-pull outputs
- Supply operation from 2.2 to 5 V
- Wide temperature range: -40°C to +125°C
- ESD tolerance: 2 kV HBM/200 V MM
- Latch-up immunity: 200 mA
- SMD packages

Applications

- Telecoms
- Instrumentation
- Signal conditioning
- High-speed sampling systems
- Portable communication systems

Description

The TS3011 single comparator features a high-speed response time with rail-to-rail inputs. Specified for a supply voltage of 2.2 to 5 V, this comparator can operate over a wide temperature range of -40°C to +125°C.

The TS3011 offers micropower consumption as low as a few hundred microamperes, thus providing an excellent ratio of power consumption current versus response time.

The TS3011 includes push-pull outputs and is available in small packages (SMD): SOT23-5 and SC70-5.

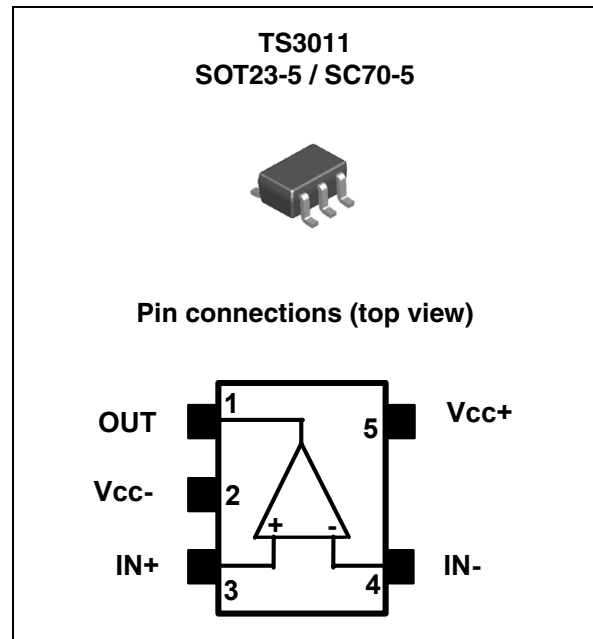

1 Absolute maximum ratings and operating conditions

Table 1. Absolute maximum ratings

Symbol	Parameter	Value	Unit
V _{CC}	Supply voltage ⁽¹⁾	5.5	V
V _{ID}	Differential input voltage ⁽²⁾	±5	V
V _{IN}	Input voltage range	(V _{CC-}) - 0.3 to (V _{CC+}) + 0.3	V
R _{THJA}	Thermal resistance junction to ambient ⁽³⁾ SC70-5 SOT23-5	205 250	°C/W
R _{THJC}	Thermal resistance junction to case ⁽³⁾ SC70-5 SOT23-5	172 81	°C/W
T _{STG}	Storage temperature	-65 to +150	°C
T _J	Junction temperature	150	°C
T _{LEAD}	Lead temperature (soldering 10 seconds)	260	°C
ESD	Human body model (HBM) ⁽⁴⁾	2000	V
	Machine model (MM) ⁽⁵⁾	200	
	Charged device model (CDM) ⁽⁶⁾ SOT23-5 SC70-5	1500 1300	
	Latch-up immunity	200	mA

1. All voltage values, except the differential voltage, are referenced to V_{CC-}.
2. The magnitude of input and output voltages must never exceed the supply rail ±0.3 V.
3. Short-circuits can cause excessive heating. These values are typical.
4. Human body model: a 100 pF capacitor is charged to the specified voltage, then discharged through a 1.5 kΩ resistor between two pins of the device. This is done for all couples of connected pin combinations while the other pins are floating.
5. Machine model: a 200 pF capacitor is charged to the specified voltage, then discharged directly between two pins of the device with no external series resistor (internal resistor < 5 Ω). This is done for all couples of connected pin combinations while the other pins are floating.
6. Charged device model: all pins and package are charged together to the specified voltage and then discharged directly to ground.

Table 2. Operating conditions

Symbol	Parameter	Value	Unit
T _{Oper}	Operating temperature range	-40 to +125	°C
V _{CC}	Supply voltage (V _{CC+} - V _{CC-}) -40°C < T _{amb} < +125°C	2.2 to 5	V
V _{ICM}	Common mode input voltage range -40°C < T _{amb} < +125°C	(V _{CC-}) - 0.2 to (V _{CC+}) + 0.2	V

2 Electrical characteristics

Table 3. $V_{CC} = +2.2\text{ V}$, $V_{ICM} = V_{CC}/2$, $T_{amb} = +25^\circ\text{C}$ (unless otherwise specified)⁽¹⁾

Symbol	Parameter	Test conditions	Min.	Typ.	Max.	Unit
V_{IO}	Input offset voltage ⁽²⁾	$-40^\circ\text{C} < T_{amb} < +125^\circ\text{C}$	-7 -8	-0.2	7 8	mV
ΔV_{IO}	Input offset voltage drift	$-40^\circ\text{C} < T_{amb} < +125^\circ\text{C}$		5	20	$\mu\text{V}/^\circ\text{C}$
V_{HYST}	Input hysteresis voltage ⁽³⁾			2		mV
I_{IO}	Input offset current ⁽⁴⁾	$-40^\circ\text{C} < T_{amb} < +125^\circ\text{C}$		1	20 100	pA
I_{IB}	Input bias current	$-40^\circ\text{C} < T_{amb} < +125^\circ\text{C}$		1	20 100	pA
I_{CC}	Supply current	No load, output high $-40^\circ\text{C} < T_{amb} < +125^\circ\text{C}$ No load, output low $-40^\circ\text{C} < T_{amb} < +125^\circ\text{C}$		0.52 0.65	0.64 0.9 0.88 1.1	mA
I_{SC}	Short circuit current	Source Sink	14 11	18 14		mA
V_{OH}	Output voltage high	$I_{source} = 4\text{ mA}$ $-40^\circ\text{C} < T_{amb} < +125^\circ\text{C}$	1.94 1.85	1.97		V
V_{OL}	Output voltage low	$I_{sink} = 4\text{ mA}$ $-40^\circ\text{C} < T_{amb} < +125^\circ\text{C}$		150	190 250	mV
CMRR	Common mode rejection ratio	$0 < V_{ICM} < 2.7\text{ V}$	50	68		dB
T_{PLH}	Propagation delay ⁽⁵⁾ low to high output level	$C_L = 12\text{ pF}$, $R_L = 1\text{ M}\Omega$ Overdrive = 5 mV Overdrive = 15 mV Overdrive = 50 mV		16 12 10	15	ns
T_{PHL}	Propagation delay ⁽⁶⁾ high to low output level	$C_L = 12\text{ pF}$, $R_L = 1\text{ M}\Omega$ Overdrive = 5 mV Overdrive = 15 mV Overdrive = 50 mV		16 12 10	15	ns
T_R	Rise time (10% to 90%)	$C_L = 12\text{ pF}$, $R_L = 1\text{ M}\Omega$ Overdrive = 100 mV		3.0		ns
T_F	Fall time (90% to 10%)	$C_L = 12\text{ pF}$, $R_L = 1\text{ M}\Omega$ Overdrive = 100 mV		2.5		ns

1. All values over the temperature range are guaranteed through correlation and simulation. No production tests are performed at the temperature range limits.
2. The offset is defined as the average value of positive (V_{TRIP+}) and negative (V_{TRIP-}) trip points (input voltage differences requested to change the output state in each direction).
3. Hysteresis is a built-in feature of the TS3011. It is defined as the voltage difference between the trip points.
4. Maximum values include unavoidable inaccuracies of the industrial tests.
5. Overdrive is measured with reference to the V_{TRIP+} point.
6. Overdrive is measured with reference to the V_{TRIP-} point.

Table 4. $V_{CC} = +2.7\text{ V}$, $V_{ICM} = V_{CC}/2$, $T_{amb} = +25^\circ\text{C}$ (unless otherwise specified)⁽¹⁾

Symbol	Parameter	Test conditions	Min.	Typ.	Max.	Unit
V_{IO}	Input offset voltage ⁽²⁾	$-40^\circ\text{C} < T_{amb} < +125^\circ\text{C}$	-7 -9	-0.1	7 9	mV
ΔV_{IO}	Input offset voltage drift	$-40^\circ\text{C} < T_{amb} < +125^\circ\text{C}$		5	20	$\mu\text{V}/^\circ\text{C}$
V_{HYST}	Input hysteresis voltage ⁽³⁾			2		mV
I_{IO}	Input offset current ⁽⁴⁾	$-40^\circ\text{C} < T_{amb} < +125^\circ\text{C}$		1	20 100	pA
I_{IB}	Input bias current	$-40^\circ\text{C} < T_{amb} < +125^\circ\text{C}$		1	20 100	pA
I_{CC}	Supply current	No load, output high $-40^\circ\text{C} < T_{amb} < +125^\circ\text{C}$		0.52	0.65 0.9	mA
		No load, output low $-40^\circ\text{C} < T_{amb} < +125^\circ\text{C}$		0.66	0.89 1.1	
I_{SC}	Short circuit current	Source	24	27		mA
		Sink	19	22		
V_{OH}	Output voltage high	$I_{source} = 4\text{ mA}$ $-40^\circ\text{C} < T_{amb} < +125^\circ\text{C}$	2.48 2.40	2.52		V
V_{OL}	Output voltage low	$I_{sink} = 4\text{ mA}$ $-40^\circ\text{C} < T_{amb} < +125^\circ\text{C}$		130	170 220	mV
CMRR	Common mode rejection ratio	$0 < V_{ICM} < 2.7\text{ V}$	52	70		dB
T_{PLH}	Propagation delay ⁽⁵⁾ low to high output level	$C_L = 12\text{ pF}$, $R_L = 1\text{ M}\Omega$ Overdrive = 5 mV		16		ns
		Overdrive = 15 mV		11		
		Overdrive = 50 mV		9	13	
T_{PHL}	Propagation delay ⁽⁶⁾ high to low output level	$C_L = 12\text{ pF}$, $R_L = 1\text{ M}\Omega$ Overdrive = 5 mV		16		ns
		Overdrive = 15 mV		11		
		Overdrive = 50 mV		9	13	
T_R	Rise time (10% to 90%)	$C_L = 12\text{ pF}$, $R_L = 1\text{ M}\Omega$ Overdrive = 100 mV		2.3		ns
T_F	Fall time (90% to 10%)	$C_L = 12\text{ pF}$, $R_L = 1\text{ M}\Omega$ Overdrive = 100 mV		1.8		ns

1. All values over the temperature range are guaranteed through correlation and simulation. No production tests are performed at the temperature range limits.
2. The offset is defined as the average value of positive (V_{TRIP+}) and negative (V_{TRIP-}) trip points (input voltage differences requested to change the output state in each direction).
3. Hysteresis is a built-in feature of the TS3011. It is defined as the voltage difference between the trip points.
4. Maximum values include unavoidable inaccuracies of the industrial tests.
5. Overdrive is measured with reference to the V_{TRIP+} point.
6. Overdrive is measured with reference to the V_{TRIP-} point.

Table 5. $V_{CC} = +5\text{ V}$, $V_{ICM} = V_{CC}/2$, $T_{amb} = +25^\circ\text{C}$ (unless otherwise specified)⁽¹⁾

Symbol	Parameter	Test conditions	Min.	Typ.	Max.	Unit
V_{IO}	Input offset voltage ⁽²⁾	$-40^\circ\text{C} < T_{amb} < +125^\circ\text{C}$	-7 -9	-0.4	7 9	mV
ΔV_{IO}	Input offset voltage drift	$-40^\circ\text{C} < T_{amb} < +125^\circ\text{C}$		10	30	$\mu\text{V}/^\circ\text{C}$
V_{HYST}	Input hysteresis voltage ⁽³⁾			2		mV
I_{IO}	Input offset current ⁽⁴⁾	$-40^\circ\text{C} < T_{amb} < +125^\circ\text{C}$		1	20 100	pA
I_{IB}	Input bias current	$-40^\circ\text{C} < T_{amb} < +125^\circ\text{C}$		1	20 100	pA
I_{CC}	Supply current	No load, output high $-40^\circ\text{C} < T_{amb} < +125^\circ\text{C}$		0.47	0.69 0.9	mA
		No load, output low $-40^\circ\text{C} < T_{amb} < +125^\circ\text{C}$		0.60	0.91 1.1	
I_{SC}	Short circuit current	Source	58	62		mA
		Sink	58	64		
V_{OH}	Output voltage high	$I_{source} = 4\text{ mA}$ $-40^\circ\text{C} < T_{amb} < +125^\circ\text{C}$	4.84 4.80	4.89		V
V_{OL}	Output voltage low	$I_{sink} = 4\text{ mA}$ $-40^\circ\text{C} < T_{amb} < +125^\circ\text{C}$		90	120 180	mV
CMRR	Common mode rejection ratio	$0 < V_{ICM} < 5\text{ V}$	57	74		dB
SVR	Supply voltage rejection	$\Delta V_{CC} = 2.2\text{ V to }5\text{ V}$		79		
T_{PLH}	Propagation delay ⁽⁵⁾ low to high output level	$C_L = 12\text{ pF}$, $R_L = 1\text{ M}\Omega$ Overdrive = 5 mV		14		ns
		Overdrive = 15 mV		10		
		Overdrive = 50 mV		8	11	
T_{PHL}	Propagation delay ⁽⁶⁾ high to low output level	$C_L = 12\text{ pF}$, $R_L = 1\text{ M}\Omega$ Overdrive = 5 mV		16		ns
		Overdrive = 15 mV		11		
		Overdrive = 50 mV		9	12	
T_R	Rise time (10% to 90%)	$C_L = 12\text{ pF}$, $R_L = 1\text{ M}\Omega$ Overdrive = 100 mV		1.1		ns
T_F	Fall time (10% to 90%)	$C_L = 12\text{ pF}$, $R_L = 1\text{ M}\Omega$ Overdrive = 100 mV		1.0		ns

1. All values over the temperature range are guaranteed through correlation and simulation. No production tests are performed at the temperature range limits.
2. The offset is defined as the average value of positive (V_{TRIP+}) and negative (V_{TRIP-}) trip points (input voltage differences requested to change the output state in each direction).
3. Hysteresis is a built-in feature of the TS3011. It is defined as the voltage difference between the trip points.
4. Maximum values include unavoidable inaccuracies of the industrial tests.
5. Overdrive is measured with reference to the V_{TRIP+} point.
6. Overdrive is measured with reference to the V_{TRIP-} point.

Figure 1. Current consumption vs. power supply voltage - output low

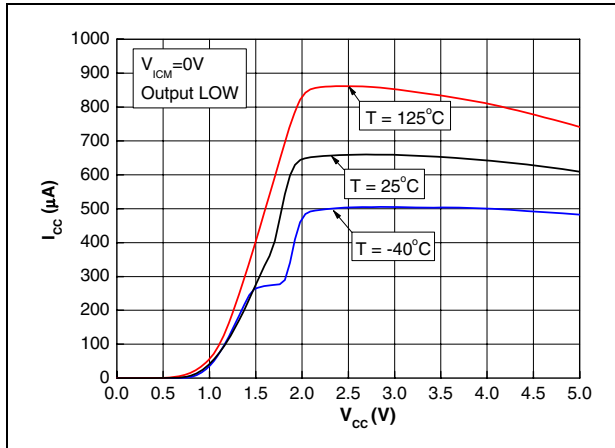

Figure 2. Current consumption vs. power supply voltage - output high

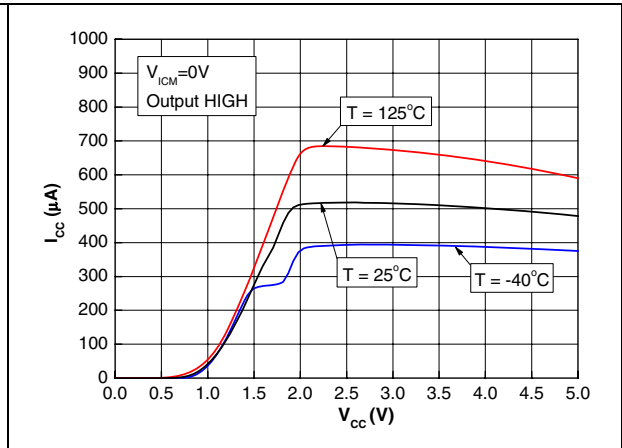

Figure 3. Current consumption vs. temperature

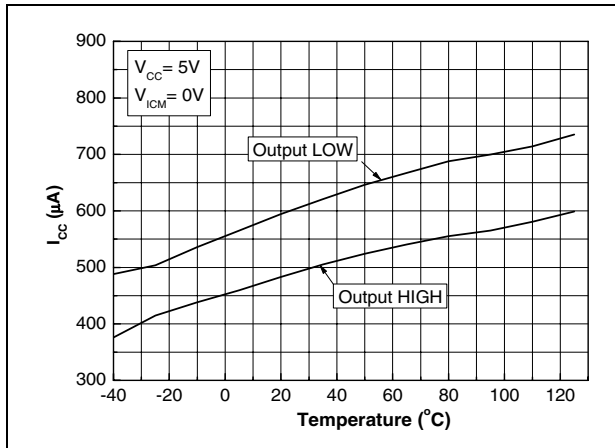

Figure 4. Output voltage vs. sinking current, output low, VCC = 2.7 V

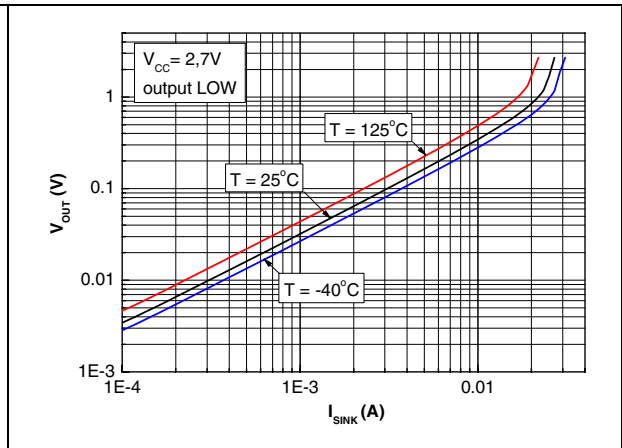

Figure 5. Output voltage vs. sinking current, output low, VCC = 5 V

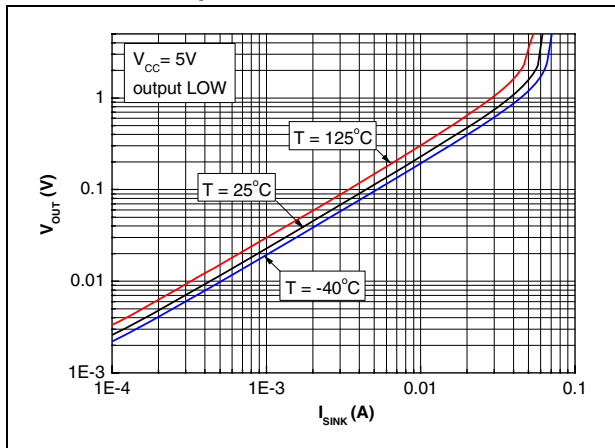

Figure 6. Output voltage drop vs. sourcing current, output high, VCC = 2.7 V

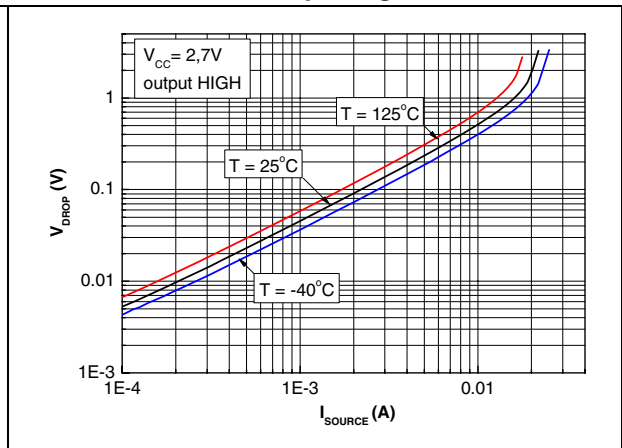

Figure 7. Output voltage drop vs. sourcing current, output high, VCC = 5 V

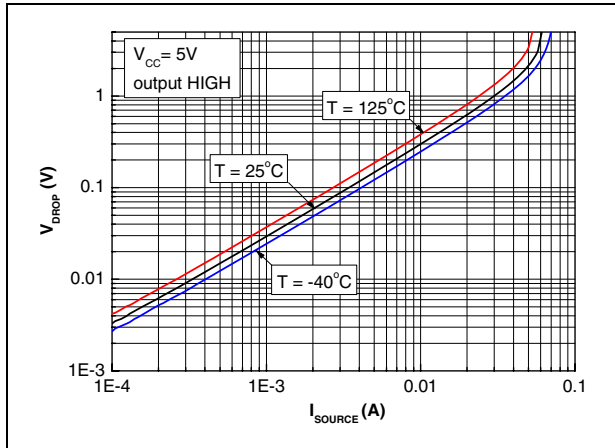

Figure 8. Input offset voltage vs. common mode voltage

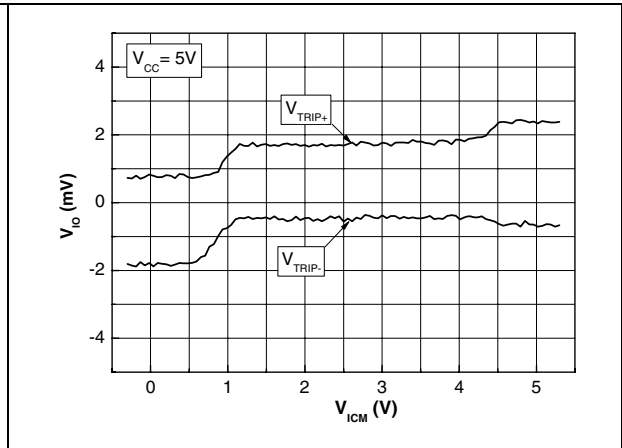

Figure 9. Input offset voltage vs. temperature

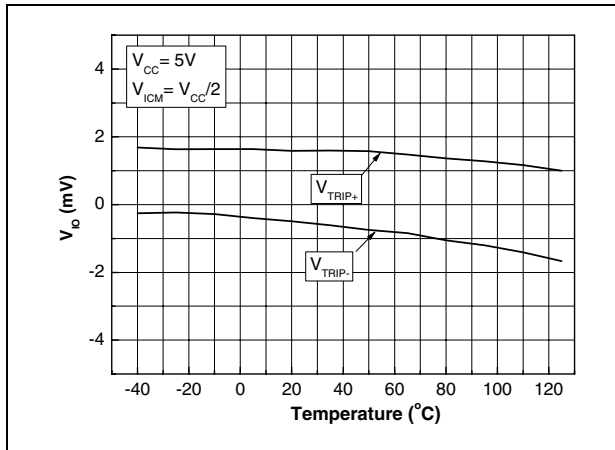

Figure 10. Propagation delay vs. common mode voltage with negative transition

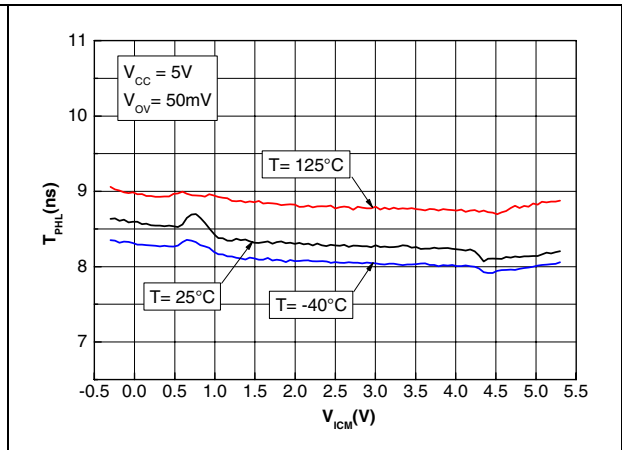

Figure 11. Propagation delay vs. common mode voltage with positive transition

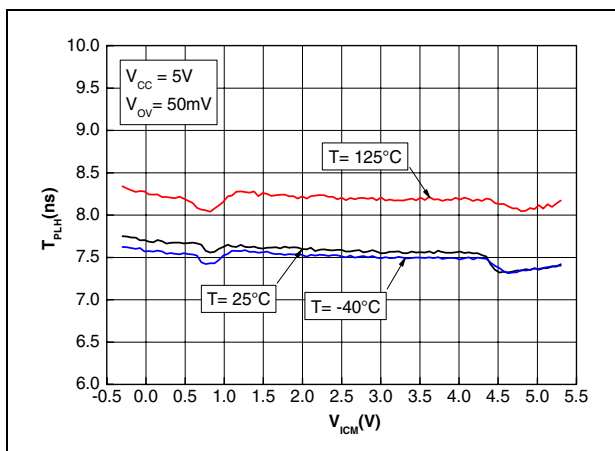

Figure 12. Propagation delay vs. power supply voltage with negative transition

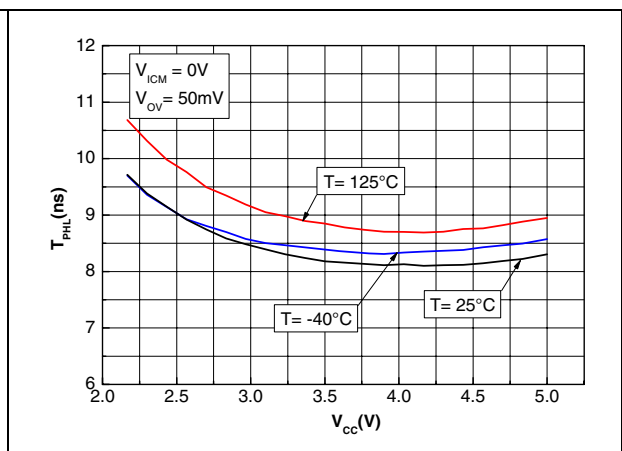

Figure 13. Propagation delay vs. power supply voltage with positive transition

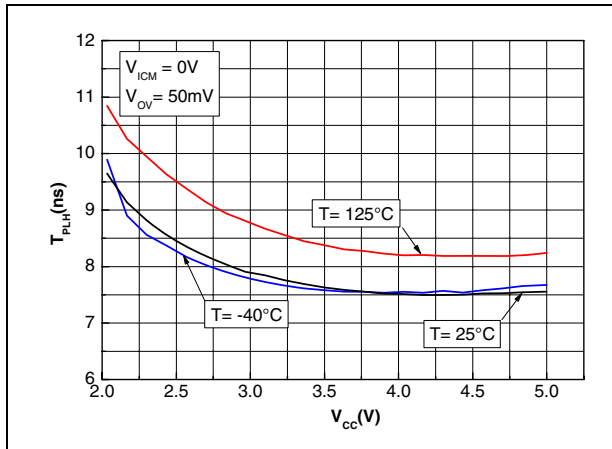

Figure 14. Propagation delay vs. overdrive with negative transition, $V_{CC} = 2.7 V$

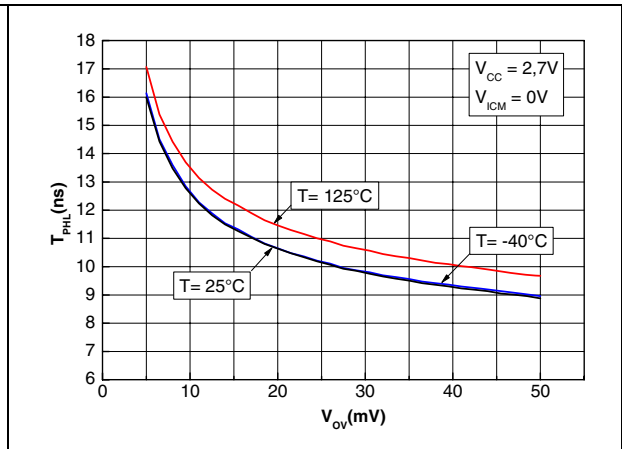

Figure 15. Propagation delay vs. overdrive with positive transition, $V_{CC} = 2.7 V$

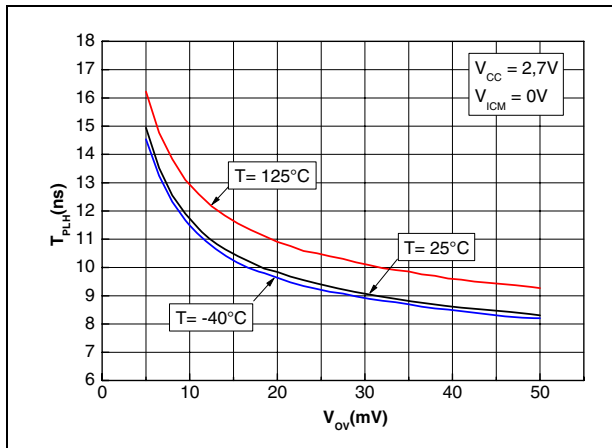

Figure 16. Propagation delay vs. overdrive with negative transition, $V_{CC} = 5 V$

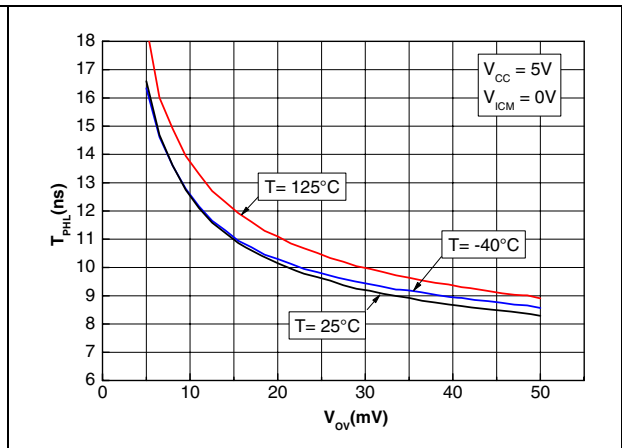

Figure 17. Propagation delay vs. overdrive with positive transition, $V_{CC} = 5 V$

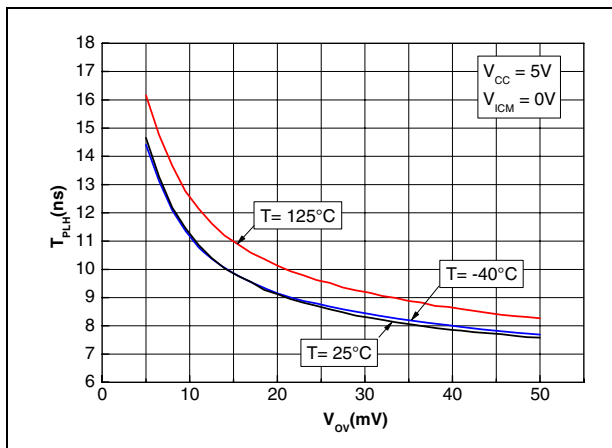
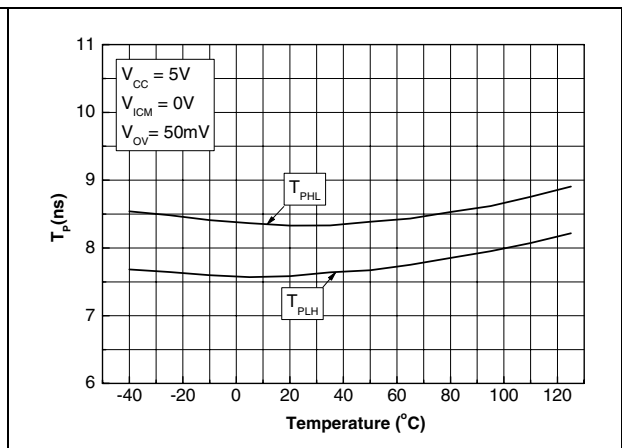

Figure 18. Propagation delay vs. temperature



3 Package information

In order to meet environmental requirements, ST offers these devices in different grades of ECOPACK[®] packages, depending on their level of environmental compliance. ECOPACK[®] specifications, grade definitions and product status are available at: www.st.com. ECOPACK[®] is an ST trademark.

3.1 SOT23-5 package mechanical data

Figure 19. SOT23-5L package mechanical drawing

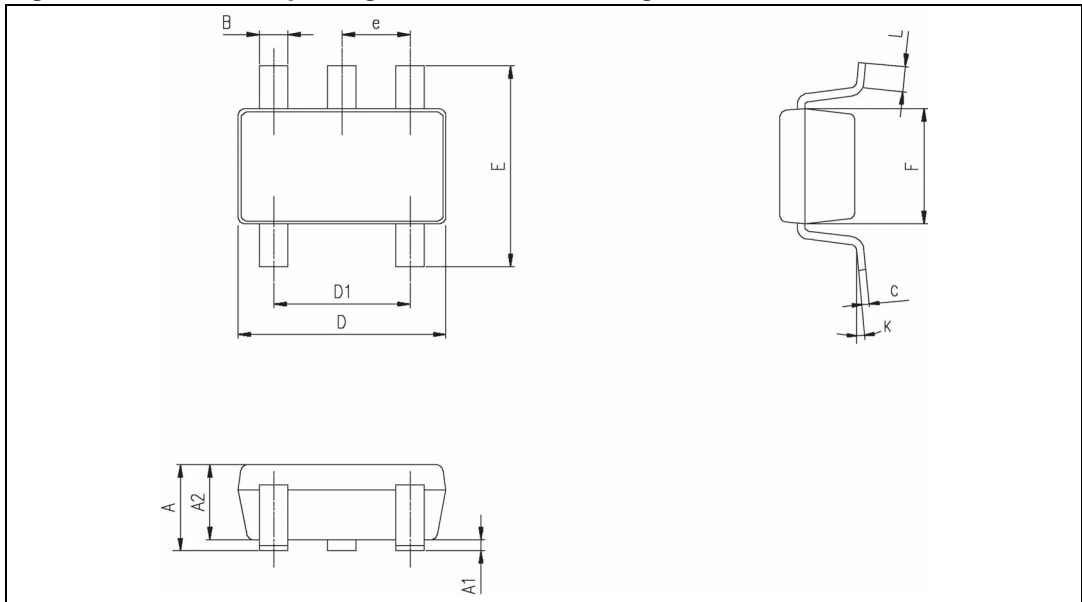

Table 6. SOT23-5L package mechanical data

Ref.	Dimensions					
	Millimeters			Inches		
	Min.	Typ.	Max.	Min.	Typ.	Max.
A	0.90	1.20	1.45	0.035	0.047	0.057
A1			0.15			0.006
A2	0.90	1.05	1.30	0.035	0.041	0.051
B	0.35	0.40	0.50	0.013	0.015	0.019
C	0.09	0.15	0.20	0.003	0.006	0.008
D	2.80	2.90	3.00	0.110	0.114	0.118
D1		1.90			0.075	
e		0.95			0.037	
E	2.60	2.80	3.00	0.102	0.110	0.118
F	1.50	1.60	1.75	0.059	0.063	0.069
L	0.10	0.35	0.60	0.004	0.013	0.023
K	0 degrees		10 degrees			

3.2 SC70-5 (SOT323-5) package mechanical data

Figure 20. SC70-5 (or SOT323-5) package mechanical drawing

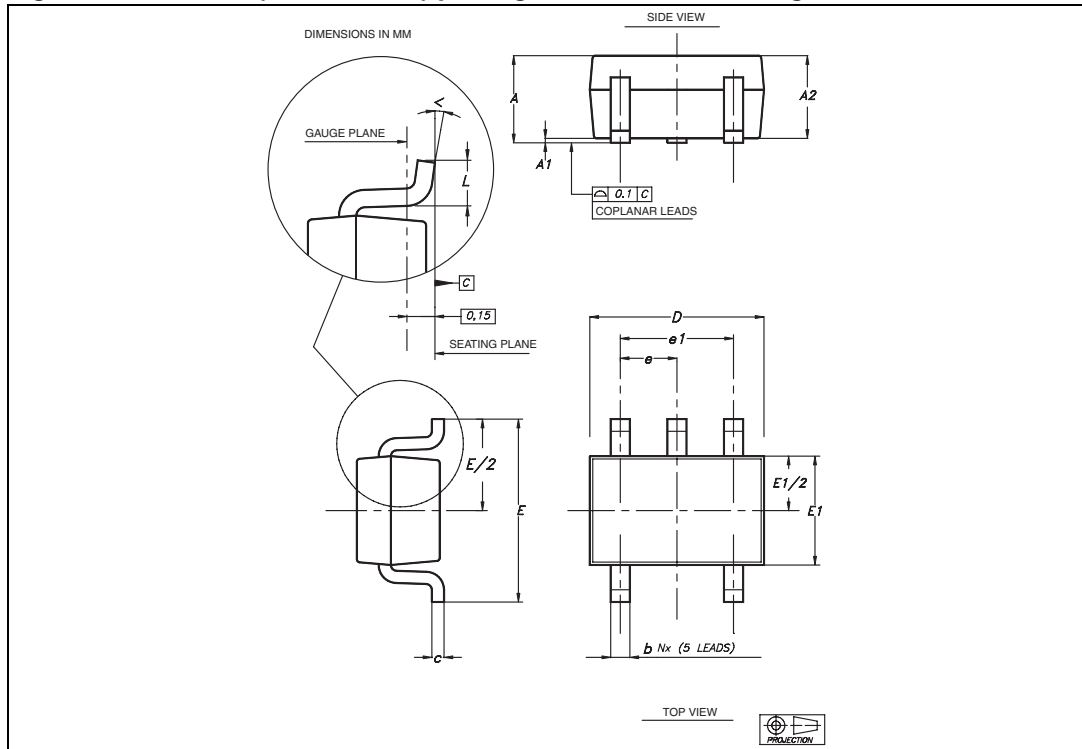

Table 7. SC70-5 (or SOT323-5) package mechanical data

Ref	Dimensions					
	Millimeters			Inches		
	Min	Typ	Max	Min	Typ	Max
A	0.80		1.10	0.315		0.043
A1			0.10			0.004
A2	0.80	0.90	1.00	0.315	0.035	0.039
b	0.15		0.30	0.006		0.012
c	0.10		0.22	0.004		0.009
D	1.80	2.00	2.20	0.071	0.079	0.087
E	1.80	2.10	2.40	0.071	0.083	0.094
E1	1.15	1.25	1.35	0.045	0.049	0.053
e		0.65			0.025	
e1		1.30			0.051	
L	0.26	0.36	0.46	0.010	0.014	0.018
α	0°		8°			

4 Ordering information

Table 8. Order codes

Part number	Temperature range	Package	Packaging	Marking
TS3011ILT	-40°C, +125°C	SOT23-5	Tape & reel	K540
TS3011ICT		SC70-5	Tape & reel	K54

5 Revision history

Table 9. Document revision history

Date	Revision	Changes
03-Oct-2011	1	Initial release.

Please Read Carefully:

Information in this document is provided solely in connection with ST products. STMicroelectronics NV and its subsidiaries ("ST") reserve the right to make changes, corrections, modifications or improvements, to this document, and the products and services described herein at any time, without notice.

All ST products are sold pursuant to ST's terms and conditions of sale.

Purchasers are solely responsible for the choice, selection and use of the ST products and services described herein, and ST assumes no liability whatsoever relating to the choice, selection or use of the ST products and services described herein.

No license, express or implied, by estoppel or otherwise, to any intellectual property rights is granted under this document. If any part of this document refers to any third party products or services it shall not be deemed a license grant by ST for the use of such third party products or services, or any intellectual property contained therein or considered as a warranty covering the use in any manner whatsoever of such third party products or services or any intellectual property contained therein.

UNLESS OTHERWISE SET FORTH IN ST'S TERMS AND CONDITIONS OF SALE ST DISCLAIMS ANY EXPRESS OR IMPLIED WARRANTY WITH RESPECT TO THE USE AND/OR SALE OF ST PRODUCTS INCLUDING WITHOUT LIMITATION IMPLIED WARRANTIES OF MERCHANTABILITY, FITNESS FOR A PARTICULAR PURPOSE (AND THEIR EQUIVALENTS UNDER THE LAWS OF ANY JURISDICTION), OR INFRINGEMENT OF ANY PATENT, COPYRIGHT OR OTHER INTELLECTUAL PROPERTY RIGHT.

UNLESS EXPRESSLY APPROVED IN WRITING BY TWO AUTHORIZED ST REPRESENTATIVES, ST PRODUCTS ARE NOT RECOMMENDED, AUTHORIZED OR WARRANTED FOR USE IN MILITARY, AIR CRAFT, SPACE, LIFE SAVING, OR LIFE SUSTAINING APPLICATIONS, NOR IN PRODUCTS OR SYSTEMS WHERE FAILURE OR MALFUNCTION MAY RESULT IN PERSONAL INJURY, DEATH, OR SEVERE PROPERTY OR ENVIRONMENTAL DAMAGE. ST PRODUCTS WHICH ARE NOT SPECIFIED AS "AUTOMOTIVE GRADE" MAY ONLY BE USED IN AUTOMOTIVE APPLICATIONS AT USER'S OWN RISK.

Resale of ST products with provisions different from the statements and/or technical features set forth in this document shall immediately void any warranty granted by ST for the ST product or service described herein and shall not create or extend in any manner whatsoever, any liability of ST.

ST and the ST logo are trademarks or registered trademarks of ST in various countries.

Information in this document supersedes and replaces all information previously supplied.

The ST logo is a registered trademark of STMicroelectronics. All other names are the property of their respective owners.

© 2011 STMicroelectronics - All rights reserved

STMicroelectronics group of companies

Australia - Belgium - Brazil - Canada - China - Czech Republic - Finland - France - Germany - Hong Kong - India - Israel - Italy - Japan - Malaysia - Malta - Morocco - Philippines - Singapore - Spain - Sweden - Switzerland - United Kingdom - United States of America

www.st.com