

USB charging controller with integrated power switch and attach detector

Datasheet - production data

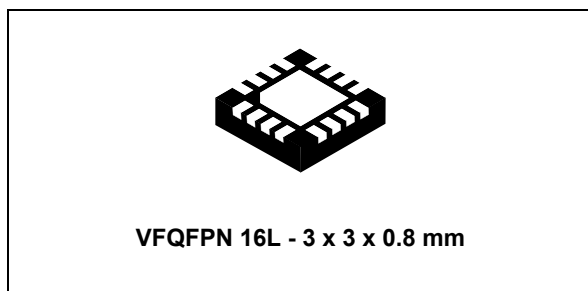

Applications

- USB ports/hubs
- Personal computers, all-in-one PCs
- Monitors
- Notebooks, ultrabooks
- Tablet PCs
- Universal wall charging adapters

Features

- Compliant with USB charging specifications BC1.2, USB 2.0 and USB 3.0 standards
- Compliant with Chinese telecommunications industry standard YD/T 1591-2009
- Compatible with proprietary charging mode (Apple® 1 A / 2 A, BlackBerry®, Korean tablets)
- Wide bandwidth, low-loss USB 2.0 data switch
- Integrated 2.5 A V_{BUS} power switch with low R_{ON} of 65 m Ω
- Constant current mode overcurrent protection
- Soft-start to limit inrush current
- Adjustable current limit up to 2.5 A
- Short-circuit, thermal and undervoltage protection
- Reverse voltage and reverse current protection
- Deglitched fault reporting output
- Supports remote wakeup in S3
- Charging indication output in DCP and CDP modes
- 3-hour safety counter for charging in S5
- Device attachment detection in G3 state
- Available in package VFQFPN 16L 3 x 3 x 0.8 mm with exposed pad
- Temperature range: -40 up to 85 °C
- UL and CB recognized components (UL file number: E354278)

Description

The STCC5011/STCC5021 device integrates, in one package, a USB charger controller, a wide bandwidth data switch and a high current power switch. The device emulates several profiles compatible with USB battery charging standard BC1.2, Chinese telecommunications standard YD/T 1591-2009 and proprietary charger modes.

The device can detect peripheral device attachment when the host is in G3 state. It asserts the CHARGING/ATTACH output after the attach event, allowing the host to turn on the high-power DC-DC converter and start charging.

This device also asserts the CHARGING/ATTACH output in DCP modes if charging current is above the threshold. In CDP mode, it asserts the CHARGING/ATTACH output after the CDP negotiation if charging current is above the threshold.

After the current drops below the threshold, the output is deasserted, allowing the host to turn off the high-power DC-DC converter and reduce overall consumption in S4/S5 states, critical when the host is battery-supplied.

These two features permit the host system to reduce consumption while no device is attached or no charging.

Contents

1	Functional description	3
2	Pin description	5
3	Absolute maximum ratings and operating conditions	6
4	Electrical characteristics	7
5	Application information	12
5.1	Supported modes	13
5.2	Remote wakeup in S3	14
5.3	V _{BUS} discharge	14
5.4	State machine	15
5.5	Attach detection	16
5.6	Charging detection and safety timer	17
5.7	Power switch	20
5.8	EN functionality	21
5.9	Input and output capacitors	21
6	Typical operating characteristics	22
7	Package information	32
8	Ordering information	34
9	Revision history	34

1 Functional description

The STCC5011 and STCC5021 devices integrate, in one package, a complete solution to charge portable devices through USB ports, including:

- Charger emulator compatible with USB battery charging BC1.2 standard, Chinese telecommunications standard YD/T 1591-2009 and proprietary chargers such as Apple® divider mode, BlackBerry® and Korean tablet charging mode.
- The Apple divider mode comes in 2 profiles:
 - 1 A max. current drawn: for Apple iPod®, iPhone® (STCC5011)
 - 2 A max. current drawn: for Apple iPad®, supporting also Apple iPod and iPhone (STCC5021)
- 3 control pins, CTL1, CTL2, CTL3 allowing the host to select the emulation profile. These pins may be controlled directly from the host USB controller or from the embedded controller.
- USB data switch with wide bandwidth up to 1100 MHz compliant with USB 2.0 standard. This wide bandwidth switch features low capacitance and low R_{ON} resistance, allowing signals to pass with minimum edge and phase distortion.
- N-channel power switch with low R_{ON} resistance of 65 mΩ typ., high current limiter accuracy and high current output capability, 2.5 A typ. The current limit threshold can be adjusted with a good accuracy by an external resistor in the range 500 mA to 2.5 A. Constant current mode protection is used to protect the device and the host system against overcurrent or short-circuit. Other protection includes reverse current and reverse voltage protection, undervoltage lockout and thermal shutdown.
- A deglitched output (\overline{FAULT}) reporting the failure events of overcurrent, thermal shutdown and reverse current (backdrive) to V_{IN} .
- Charging current sensing circuit. The output $\overline{CHARGING/ATTACH}$ is asserted if charging current is above 20 mA in CDP and DCP modes.
In CDP mode the charging flag is asserted only if the CDP handshaking between the portable device and the host is performed before the current is above the threshold. Moreover, in S4/S5 power states and battery supplied, there is an additional safety timer to stop the charging process when the “end of charge” timeout is reached. This timer is started only after a device attachment event and can be disabled by toggling pin $ATTACH_EN$ to low if timer is not wanted.
 If timeout or current is below the threshold, the signal $\overline{CHARGING/ATTACH}$ is deasserted: in both cases, the host system can disable the high power DC-DC converter and therefore reduce power consumption. This is crucial when the host is battery supplied.
- Attach detector circuit to monitor device attachment.
 This circuit is enabled by driving the $ATTACH_EN$ pin high and EN low. When a device attachment is detected, the output $\overline{CHARGING/ATTACH}$ is asserted for t_{ATTACH} period (25 s typ.). The attach detection block is supplied by the V_{DD} power supply pin.
- An enable input (EN) to enable/disable the device, except the attach detection switch which is also managed by the $ATTACH_EN$ input.

The device is offered in a small, RoHS-compliant VFQFPN 16L (3 x 3 x 0.8 mm) package with exposed pad for effective cooling.

Figure 1. Block diagram

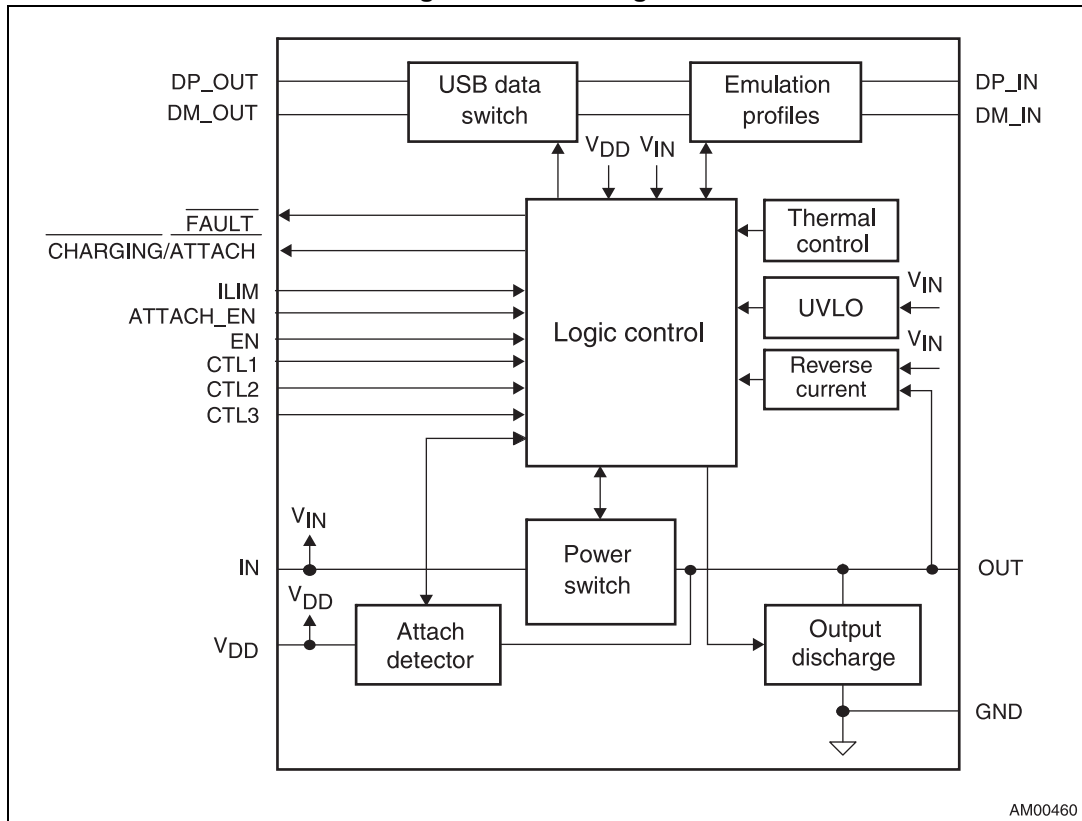
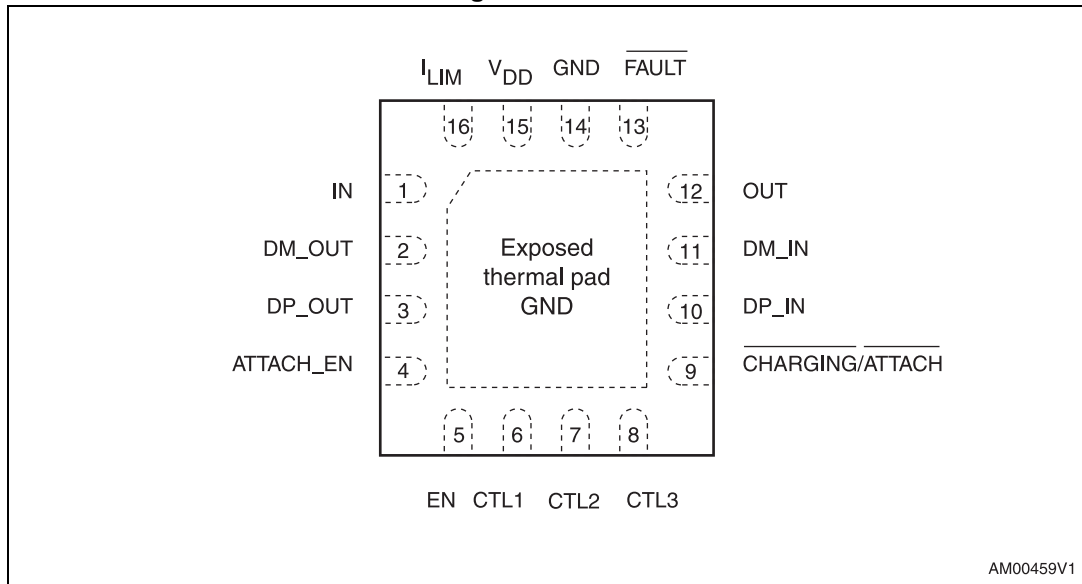

Figure 2. Pinout



2 Pin description

Table 1. Pin description

Pin No.	Name	Type	Description
1	IN	PWR	Device and USB port power supply input
2, 3	DM_OUT, DP_OUT	I/O	USB 2.0 data connection to system USB transmitter (DM = D-, DP = D+)
4	ATTACH_EN	I	Logic level control input to turn on/off the attach detector (see Table 6 on page 16). It can also disable (logic low) the 3-hour timer if started.
5	EN	I	Logic level control input. When EN is low, power switch, data switch and emulator are OFF.
6, 7, 8	CTL1, CTL2, CTL3	I	Logic level control inputs to select charger mode (see Table 5 on page 13)
9	$\overline{\text{CHARGING/ATTACH}}$	O	Active low open drain output, asserted when device attachment or charging current is detected
10, 11	DP_IN, DM_IN	I/O	USB 2.0 data connection to system USB connector (DM = D-, DP = D+)
12	OUT	PWR	USB port power supply output (V_{BUS})
13	$\overline{\text{FAULT}}$	O	Active low open drain output, asserted when overcurrent, overtemperature or reverse voltage are detected
14	GND	-	Ground
15	V_{DD}	PWR	Attach detector power supply. V_{DD} must always be supplied before V_{IN} .
16	I_{LIM}	I	Current limit threshold programming resistor terminal

3 Absolute maximum ratings and operating conditions

Stressing the device beyond the rating listed in [Table 2: Absolute maximum ratings \(AMR\)](#) may cause permanent damage to the device. These are stress ratings only and functional operation of the device at these or any other conditions beyond those indicated in [Table 3: Operating conditions](#) is not implied. Exposure to absolute maximum rating conditions for extended periods may affect device reliability.

Table 2. Absolute maximum ratings (AMR)

Symbol	Parameter	Value	Unit
V_{IN}, V_{DD}, V_{OUT}	Supply voltage	-0.3 to 6.5	V
$V_{EN}, V_{ATTACH_EN}, V_{CTLX}$	Logical input voltage	-0.3 to 6.5	V
$\frac{V_{FAULT}}{V_{CHARGING/ATTACH}}$	Pull-up resistor voltage ($\overline{FAULT}, \overline{CHARGING/ATTACH}$)	-0.3 to 6.5	V
$V_{DP_OUT}, V_{DM_OUT}, V_{DP_IN}, V_{DM_IN}$	Data switch pin voltage to ground	-0.3 to $V_{IN} + 0.3$	V
$I_{DP_OUT}, I_{DM_OUT}, I_{DP_IN}, I_{DM_IN}$	Data switch current, switch ON	±50	mA
$I_{O(OUT)}$	Maximum power switch output current, power switch ON	Internally limited	A
$\frac{I_{O(FAULT)}}{I_{O(CHARGING/ATTACH)}}$	Logical output sink current	25	mA
T_{STG}	Storage temperature (V_{IN} OFF, V_{DD} OFF)	-55 to +150	°C
T_{SLD}	Lead solder temperature for 10 second temperature (V_{IN} OFF, V_{DD} OFF) ⁽¹⁾	260	°C
R_{thja}	Thermal resistance junction-to-ambient VFQFPN 16L ⁽²⁾	60	°C/W
T_j	Maximum junction temperature range (internally limited)	-40 to T_{STOP}	°C
$V_{ESD(OUT, DP_IN, DM_IN)}$	IEC61000-4-2 contact discharge (OUT, DP_IN, DM_IN pins) ⁽³⁾	8	kV
V_{ESD}	JEDEC human body model (all pins)	2	kV
	JEDEC machine model (all pins)	200	V

1. Reflow at temperature of 255 °C to 260 °C for time < 30 seconds (total thermal budget not to exceed 180 °C for a period from 90 to 150 seconds).
2. R_{th} are typical values, given when mounted on a 4-layer PCB with vias.
3. Measured in recommended application circuit with 1 μF ceramic capacitor + 150 μF low ESR electrolytic capacitor connected between OUT and GND pins. (See [Figure 4 on page 12](#)).

Table 3. Operating conditions

Symbol	Parameter	Value	Unit
V_{IN}	Supply voltage	4.5 to 5.5	V
V_{DD}	Supply voltage	1.7 to 5.5	V
T_A	Ambient operating temperature	-40 to +85	°C
T_J	Junction operating temperature	-40 to +125	°C



4 Electrical characteristics

Table 4. Electrical characteristics $V_{IN} = 4.5\text{ V to }5.5\text{ V}$, $V_{DD} = 1.7\text{ V to }5.5\text{ V}$, $-40\text{ }^\circ\text{C} < T_J < 125\text{ }^\circ\text{C}$ (unless otherwise specified)

Symbol	Parameter	Conditions	Min.	Typ.	Max.	Unit
Current consumption (V_{IN} domain)						
$I_{IN(ACTIVE)}$	Supply current in active state (EN = 1)	Mode CDP (111)		110	160	μA
		Mode SDP (110 - 010)		100	150	
		Mode DCP auto-detect (001) – Divider mode – BC1.2		260 110	290 180	
		Mode DCP BC1.2 (100)		110	180	
		Mode DCP divider (101)		210	290	
$I_{IN(DISABLED)}$	Supply current in disable state (EN = 0)	CTLx <> 000, OUT floating		0.1	5	μA
		CTLx = 000 or OUT grounded, $T_J = 25\text{ }^\circ\text{C}$		0.2	5	
		$T_J = 125\text{ }^\circ\text{C}$			60	
Power switch - DC parameters						
R_{ON}	Static on-resistance	$T_J = 25\text{ }^\circ\text{C}$		65		$\text{m}\Omega$
		$-40\text{ }^\circ\text{C} < T_J < 125\text{ }^\circ\text{C}$			95	
$ I_{REVERSE} $	Reverse leakage current in disabled state (absolute value)	$V_{OUT} = 5.5\text{ V}$, $V_{IN} = 0$, $T_J = 25\text{ }^\circ\text{C}$, $V_{EN} = 0$, measured at IN		1	5	μA
		$T_J = 125\text{ }^\circ\text{C}$, other conditions the same as above			70	
$V_{REVERSE}$	Reverse voltage protection threshold ($V_{OUT} - V_{IN}$)	$V_{UVLO} < V_{IN} < V_{OUT}$, EN = 1, power switch ON -> OFF		60		mV
I_{OS}	Current limiter threshold	$R_{ILIM} = 96\text{ k}\Omega$	375	500	625	mA
		$R_{ILIM} = 33\text{ k}\Omega$	1305	1450	1595	
		$R_{ILIM} = 19.6\text{ k}\Omega$	2255	2450	2645	
T_{STOP}	Emergency OFF temperature		140	150	160	$^\circ\text{C}$
T_{HYST}	Thermal shutdown hysteresis			20		$^\circ\text{C}$
R_{EN}	EN input pull-down resistor			250		$\text{k}\Omega$
V_{EN}	Enable input turn-on, turn-off threshold voltage		0.4		1.6	V
$V_{HYST(EN)}$	Enable input turn-on, turn-off voltage hysteresis			500		mV
$V_{OL(\overline{\text{FAULT}})}$	$\overline{\text{FAULT}}$ output low voltage	$I_{\overline{\text{FAULT}}} = 1\text{ mA}$			180	mV
$I_{OL(\overline{\text{FAULT}})}$	$\overline{\text{FAULT}}$ output leakage current	$V_{IN} = 5.5\text{ V}$, $V_{DD} = 5.5\text{ V}$, $V_{\overline{\text{FAULT}}} = 5\text{ V}$			1	μA

Table 4. Electrical characteristics $V_{IN} = 4.5\text{ V to }5.5\text{ V}$, $V_{DD} = 1.7\text{ V to }5.5\text{ V}$, $-40\text{ }^\circ\text{C} < T_J < 125\text{ }^\circ\text{C}$ (unless otherwise specified) (continued)

Symbol	Parameter	Conditions	Min.	Typ.	Max.	Unit
$\overline{t_{FAULT}}$	\overline{FAULT} output deglitch delay	\overline{FAULT} assertion / deassertion delay in overcurrent condition	7	9	12	ms
V_{UVLO}	Undervoltage lockout	V_{IN} rising	3.9	4.1	4.3	V
$V_{HYST(UVLO)}$	Undervoltage lockout hysteresis	$T_J = 25\text{ }^\circ\text{C}$		100		mV
Power switch - AC parameters⁽¹⁾						
t_{ON}	Turn-on, EN to OUT delay	$C_{LOAD} = 1\text{ }\mu\text{F}$, $R_{LOAD} = 100\text{ }\Omega$		0.8		ms
t_{OFF}	Turn-off, EN to OUT delay			0.3		ms
t_R	OUT (V_{BUS}) rise time	$C_{LOAD} = 1\text{ }\mu\text{F}$, $R_{LOAD} = 100\text{ }\Omega$		0.4		ms
t_F	OUT (V_{BUS}) fall time	$C_{LOAD} = 1\text{ }\mu\text{F}$, $R_{LOAD} = 100\text{ }\Omega$		0.2		ms
t_{IOS}	Current limiter response time to short-circuit	$V_{IN} = 5.5\text{ V}$		3.5		μs
Output discharge						
$R_{DISCHARGE}$	Discharge resistor	ATTACH_EN = EN = 0	140	200	300	Ω
Attach detector						
V_{DD}	Supply voltage		1.7		5.5	V
$I_{DD(ACTIVE)}$	Supply current in active state	$V_{DD} = 1.7\text{ V to }5.5\text{ V}$, $V_{EN} = 0$, $V_{ATTACH_EN} = V_{DD}$, $T_J = 25\text{ }^\circ\text{C}$		15	30	μA
$I_{DD(DISABLED)}$	Supply current in disabled state	$V_{DD} = 1.7\text{ to }5.5\text{ V}$, $V_{EN} = 0$, $V_{ATTACH_EN} = 0$		0.1	3	μA
$ I_{ATT_REVERSE} $	Detector switch reverse current (V_{OUT} to V_{DD}) (absolute value)	$V_{DD} = 0$, $V_{OUT} = 5.5\text{ V}$, IN floating, measured at V_{DD}		0.1	3	μA
R_{ON_ATT}	Static on-resistance V_{DD} to V_{OUT}	$T_J = 25\text{ }^\circ\text{C}$		100		Ω
V_{ATTACH_EN}	Enable input turn-on, turn-off threshold voltage		0.4		1.6	V
$V_{HYST(ATTACH_EN)}$	Enable input threshold hysteresis			500		mV
I_{ATTACH_EN}	ATTACH_EN input leakage current	$V_{DD} = 5.5\text{ V}$, $V_{IN} = 5.5\text{ V}$, $V_{ATTACH_EN} = 0\text{ V or }5\text{ V}$	-1		1	μA
$V_{OL(CHARGING/ATTACH)}$	$\overline{CHARGING/ATTACH}$ output low voltage	Device attachment detected, $\overline{I_{CHARGING/ATTACH}} = 1\text{ mA}$			180	mV
$I_{OL(CHARGING/ATTACH)}$	$\overline{CHARGING/ATTACH}$ output leakage current	$V_{IN} = 5.5\text{ V}$, $V_{DD} = 5.5\text{ V}$, $V_{CHARGING/ATTACH} = 5\text{ V}$			1	μA
t_{ATTACH}	$\overline{CHARGING/ATTACH}$ assertion time after attach detected			25		s

**Table 4. Electrical characteristics $V_{IN} = 4.5\text{ V to }5.5\text{ V}$, $V_{DD} = 1.7\text{ V to }5.5\text{ V}$, $-40\text{ }^\circ\text{C} < T_J < 125\text{ }^\circ\text{C}$
(unless otherwise specified) (continued)**

Symbol	Parameter	Conditions	Min.	Typ.	Max.	Unit
High-speed data switch - DC parameters						
R_{ON}	Data switch on-resistance	Switch closed, $V_{IN} = 5\text{ V}$, $I_S = 8\text{ mA}$, test voltage on DP_OUT, DM_OUT = 0.4 V		2.5	4	Ω
R_{ON}	Data switch on-resistance	Switch closed, $V_{IN} = 5\text{ V}$, $I_S = 8\text{ mA}$, test voltage on DP_OUT, DM_OUT = 3 V		2.7	4	Ω
I_{OFF}	OFF state leakage current	$V_{EN} = 0\text{ V}$, $V_{DP/DM_IN} = 3.6\text{ V}$, $V_{DP/DM_OUT} = 0\text{ V}$, measure IDP/DM_OUT			1.5	μA
High-speed data switch - AC parameters⁽¹⁾						
X_{TALK}	DP, DM crosstalk	$R_{TERM} = 50\ \Omega$, $C_{LOAD} = 5\text{ pF}$, $V_S = 1\text{ V}_{rms}$, signal = 0 dBm, $f = 250\text{ MHz}$		47		dB
O_{IRR}	OFF state isolation	$R_{TERM} = 50\ \Omega$, $C_{LOAD} = 5\text{ pF}$, $V_S = 1\text{ V}_{rms}$, signal = 0 dBm, $f = 250\text{ MHz}$		17		dB
B_w	Bandwidth -3 dB	$R_{TERM} = 50\ \Omega$, $C_{LOAD} = 5\text{ pF}$, signal = 0 dBm		1100		MHz
Charger emulator - BC1.2 DCP mode						
R_{DCP_RES}	DP_IN to DM_IN short resistance	CTLx configured for DCP BC1.2		100	170	Ω
Charger emulator - divider mode						
V_{DM_1A}	DM_IN output voltage	STCC5011, device set to DCP auto-detect mode or divider mode, $V_{IN} = 5.0\text{ V}$	2.65	2.7	2.75	V
V_{DP_1A}	DP_IN output voltage		1.96	2	2.04	V
R_{DM_1A}	DM_IN output resistance	STCC5011, device set to DCP auto-detect mode or divider mode, $V_{IN} = 5.0\text{ V}$		27		k Ω
R_{DP_1A}	DP_IN output resistance			27		k Ω
V_{DM_2A}	DM_IN output voltage	STCC5021, device set to DCP auto-detect mode or divider mode, $V_{IN} = 5.0\text{ V}$	1.96	2	2.04	V
V_{DP_2A}	DP_IN output voltage		2.65	2.7	2.75	V
R_{DM_2A}	DM_IN output resistance	STCC5021, device set to DCP auto-detect mode or divider mode, $V_{IN} = 5.0\text{ V}$		27		k Ω
R_{DP_2A}	DP_IN output resistance			27		k Ω

Table 4. Electrical characteristics $V_{IN} = 4.5\text{ V to }5.5\text{ V}$, $V_{DD} = 1.7\text{ V to }5.5\text{ V}$, $-40\text{ }^\circ\text{C} < T_J < 125\text{ }^\circ\text{C}$ (unless otherwise specified) (continued)

Symbol	Parameter	Conditions	Min.	Typ.	Max.	Unit
Charger emulator - BC1.2 CDP mode						
V_{DM_SRC}	Voltage source on DM_IN for CDP detection	$V_{DP_IN} = 0.6\text{ V}$, device in CDP BC1.2 mode	0.5	0.6	0.7	V
V_{DAT_REF}	DP_IN rising voltage threshold to turn on V_{DM_SRC}	$I_{DM_IN} = -250\text{ }\mu\text{A}$, device in CDP BC1.2 mode	0.25	0.32	0.4	V
$V_{DAT_REF_HYST}$	V_{DAT_REF} hysteresis			40		mV
V_{LGC_SRC}	DP_IN rising voltage threshold to turn off V_{DM_SRC}		0.8		1	V
$V_{LGC_SRC_HYST}$	V_{LGC_SRC} hysteresis			40		mV
I_{DP_SINK}	DP_IN sink current		$0.4 < V_{DP_IN} < 0.8\text{ V}$, device in CDP BC1.2 mode	50	75	150
Charger emulator - timings						
$t_{CHG_DGL_ON}$	Charging indication ON deglitch delay	From $I_{OUT} > I_{OUT_TH}$ to $\overline{\text{CHARGING/ATTACH}}$ asserted		0.5		s
$t_{CHG_DGL_OFF}$	Charging indication OFF deglitch delay	From $I_{OUT} \leq I_{OUT_TH}$ to $\overline{\text{CHARGING}}$ deasserted		5		s
$t_{VDM_SRC_ON}$	DM_IN voltage source turn-on time	From $V_{DP_IN} 0\text{ V} \rightarrow 0.6\text{ V}$ to $V_{DM_IN} = V_{DM_SRC}$, CTLx configured for CDP BC1.2		8		ms
$t_{VDM_SRC_OFF}$	DM_IN voltage source turn-off time	From $V_{DP_IN} 0.6\text{ V} \rightarrow 0\text{ V}$ to $V_{DM_IN} = 0\text{ V}$, CTLx configured for CDP BC1.2		1.3		ms
t_{VBUS_REAPP}	OUT discharge pulse width	From V_{OUT} falling to 0.7 V during discharge to V_{OUT} returning to 90%.	300	350	400	ms
Charger emulator - control pins CTLx						
V_{CTLx}	CTLx pins threshold voltage		0.4		1.6	V
$V_{HYST(CTLx)}$	Hysteresis voltage on CTLx pins			500		mV
I_{CTLx}	Leakage current	$V_{DD} = 5.5\text{ V}$, $V_{IN} = 5.5\text{ V}$, $V_{CTLx} = 0\text{ V or }5\text{ V}$	-1		1	μA

Table 4. Electrical characteristics $V_{IN} = 4.5\text{ V to }5.5\text{ V}$, $V_{DD} = 1.7\text{ V to }5.5\text{ V}$, $-40\text{ }^\circ\text{C} < T_J < 125\text{ }^\circ\text{C}$ (unless otherwise specified) (continued)

Symbol	Parameter	Conditions	Min.	Typ.	Max.	Unit
Charger emulator - charging indication						
I_{OUT_TH}	Output current threshold for charging detection	DCP mode, CDP mode		20		mA
$V_{OL(\overline{\text{CHARGING/ATTACH}})}$	$\overline{\text{CHARGING/ATTACH}}$ output low voltage	Charging detected ($I_{OUT} > I_{OUT_TH}$) and charging time in S5 $< t_{EOCH}$ (end of charge safety timer), $I_{\overline{\text{CHARGING/ATTACH}}} = 1\text{ mA}$			180	mV
$I_{OL(\overline{\text{CHARGING/ATTACH}})}$	$\overline{\text{CHARGING/ATTACH}}$ output leakage current	$V_{DD} = 5.5\text{ V}$, $V_{IN} = 5.5\text{ V}$, $V_{\overline{\text{CHARGING/ATTACH}}} = 5\text{ V}$			1	μA
Charger emulator - safety timer⁽¹⁾						
t_{EOCH}	Charging timeout after attach detection	From $I_{OUT} > I_{OUT_TH}$ after attach detection to $\overline{\text{CHARGING/ATTACH}}$ deasserted		3		hours

1. Guaranteed by design. Not tested in production.

Figure 3. Timing waveforms

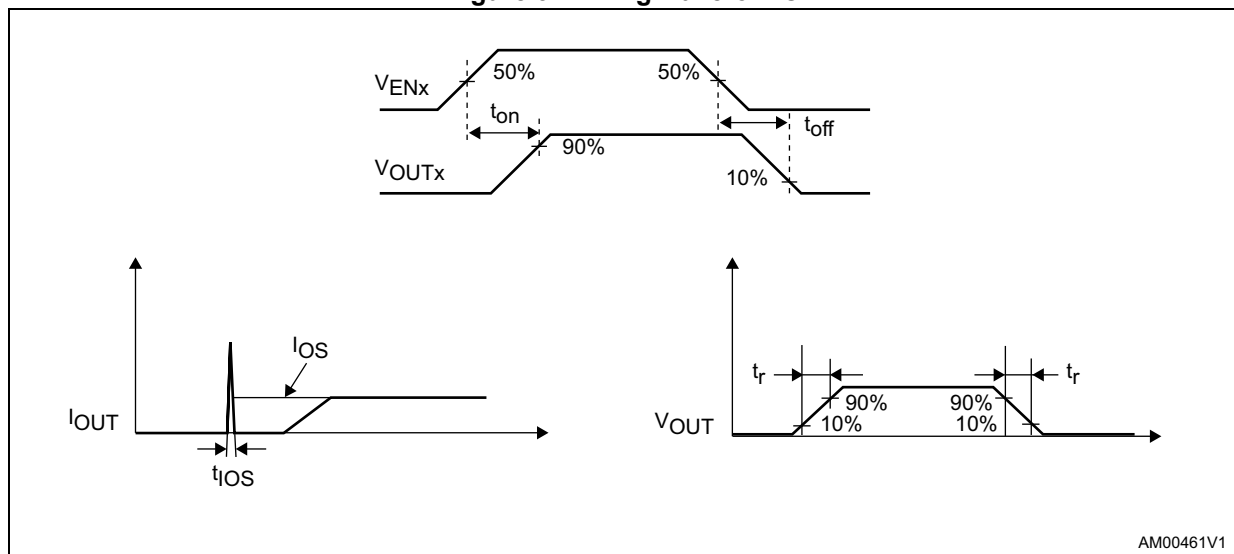

5 Application information

The STCC5011 and STCC5021 devices are designed to be implemented into the PC on a USB port in order to emulate the wall charger adapter when the PC is in standby mode or OFF, and to allow higher charge current when the USB interface is used for data communication. In order to handle these functionalities, the STCC5011/STCC5021 devices rely on USB BC1.2 specifications, Chinese telecommunications industry standard YD/T 1591-2009 and proprietary implementations

- BC1.2 charging profiles are:
 - CDP: charging downstream port providing data communication plus charging (active USB data communications with 1.5 A support)
 - SDP: standard downstream port providing data communication with no charging (active USB 3.0 data communications with 900 mA support or USB 2.0 data communications with 500 mA support)
 - DCP: dedicated charging port (wall charger emulation with no data communication and 500 mA to 1.5 A support)
- Chinese telecommunications standard
 - D+ and D- shorted to allow charging
- Apple divider mode comes in 2 profiles
 - 1 A max. current drawn by Apple iPod, iPhone (STCC5011)
 - 2 A max. current drawn by Apple iPad, supporting also Apple iPod and iPhone (STCC5021)
- BlackBerry emulator mode
- Legacy mode (allowing 500 mA charging current)
- Korean tablet charging mode (D+ and D- shorted and pulled up to a certain voltage)

Figure 4. Typical application diagram

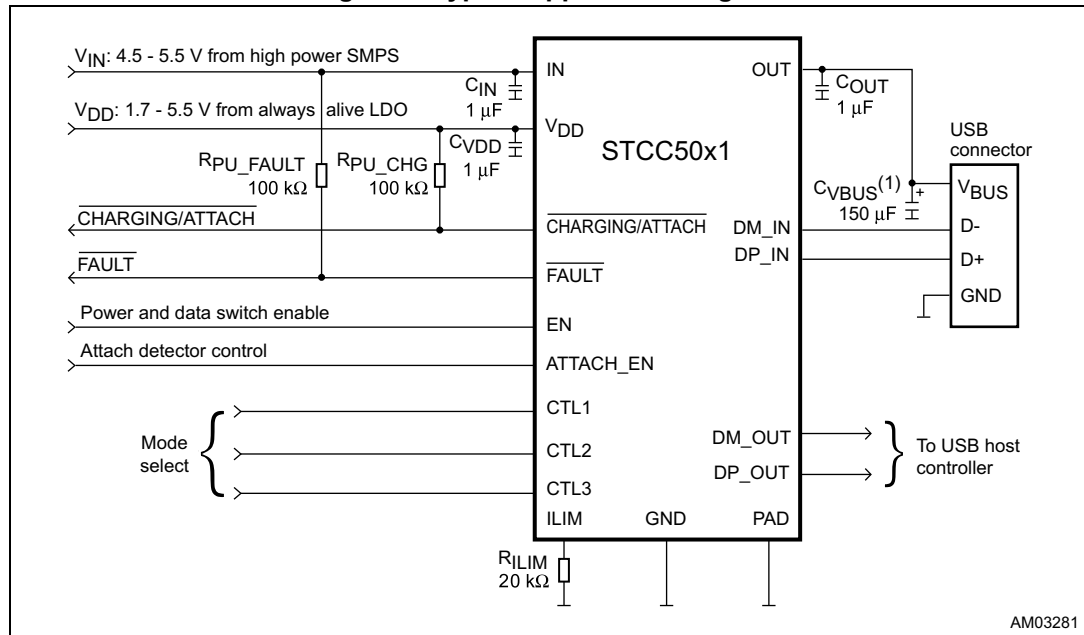

1. C_{VBUS} required by the USB specification.

5.1 Supported modes

For more information refer to [Section 5.4: State machine](#).

The STCC5011/STCC5021 device supports the following modes:

- SDP BC1.2
- CDP BC1.2
- SDP with remote wakeup for all USB devices
- CDP with remote wakeup for low-speed USB devices with automatic transition to DCP auto-mode if a full-speed/high-speed USB device attached or after a USB device detached
- DCP auto-detect: this mode permits auto-detection of charging modes between DCP BC1.2 (shorted D+, D-) and divider charging mode. It also supports BlackBerry charging mode and can charge legacy devices and Korean tablets.
- Forced DCP BC1.2 mode
- Forced DCP divider mode

The auto-detect mode starts in divider mode. If charging negotiation attempt is detected, there is an automatic transition to DCP BC1.2 mode. It is preceded by V_{BUS} discharge pulse to initialize the proper BC1.2 handshake process. If the BC1.2 device is detached, the circuit automatically returns to divider mode after a 10 s (typ.) timeout.

Note: From application point of view it means that after removing one device the user should wait for approx. 15 s before attaching another device.

Selection between these modes is done through the CTLx control pins. The CTLx pins may be controlled by the host in different ways:

- GPIO from embedded controller
- Hardware signals from USB host controller (SLP_S3#, SLP_S4#) and AC_adapter signal from embedded controller
- Hardware signals SUSPEND from embedded controller and AC_ADAPTER.

Table 5. Truth table control pins CTLx

Host state	CTL1	CTL2	CTL3	Mode description
	0	0	0	Device off, output discharge
S0, S1	1	1	0	SDP
S0, S1	1	1	1	CDP BC1.2 with charging detection.
S3	0	1	0	SDP with remote wakeup for all USB devices
S3	0	1	1	CDP with remote wakeup for low-speed USB devices / DCP auto-mode for full-speed or high-speed USB devices or after a USB device detached
S4, S5	0	0	1	DCP auto-detect mode without remote wakeup, with charging detection
S4, S5	1	0	1	Forced DCP divider mode with charging detection
S4, S5	1	0	0	Forced DCP BC1.2 mode with charging detection

5.2 Remote wakeup in S3

For more information refer to [Section 5.4: State machine](#).

If the CTLx pins are controlled by hardware signals (such as SLP_Sx# or SUSPEND), the CTLx combination changes when host transitions from S0 to S3 and back. In this case, the STCC5011/STCC5021 device can support remote wakeup of portable devices for the following transitions (i.e. no V_{BUS} discharge pulse and data switch ON):

- SDP S0 (CTLx = 110) to and from SDP S3 (CTLx = 010) for all USB devices
- SDP (CTLx = x10) and CDP S0 (CTLx = 111) to and from CDP S3 (CLx = 011) for low-speed USB devices only.

If the host system is in S3 mode (CTLx = 011), the system automatically turns into DCP auto-mode for already attached full-speed / high-speed USB devices or after any USB device is detached. Thus, already attached full-speed / high-speed devices or newly attached devices are charged without the need of CTLx transition.

If the S0 to S3 transition is managed by GPIO from the embedded controller, the easiest solution is to keep the same levels on the CTLx pins (SDP or CDP modes). Therefore, remote wakeup in S3 is supported for all USB devices but the system does not automatically turn into DCP auto-mode.

5.3 V_{BUS} discharge

The V_{BUS} discharge pulse lasts for 350 ms typ. ($t_{V_{BUS_REAPP}}$) and is performed for any transitions between the modes listed in [Table 5](#), except the modes allowing remote wakeup in S3 [transitions (x10) and (111) to/from (011)].

Permanent output discharge is provided in following modes:

- EN = 0, ATTACH_EN = 0, CTLx = xxx (ignored)
- EN = 1, ATTACH_EN = 0, CTLx = 000.

5.4 State machine

Figure 5. State machine

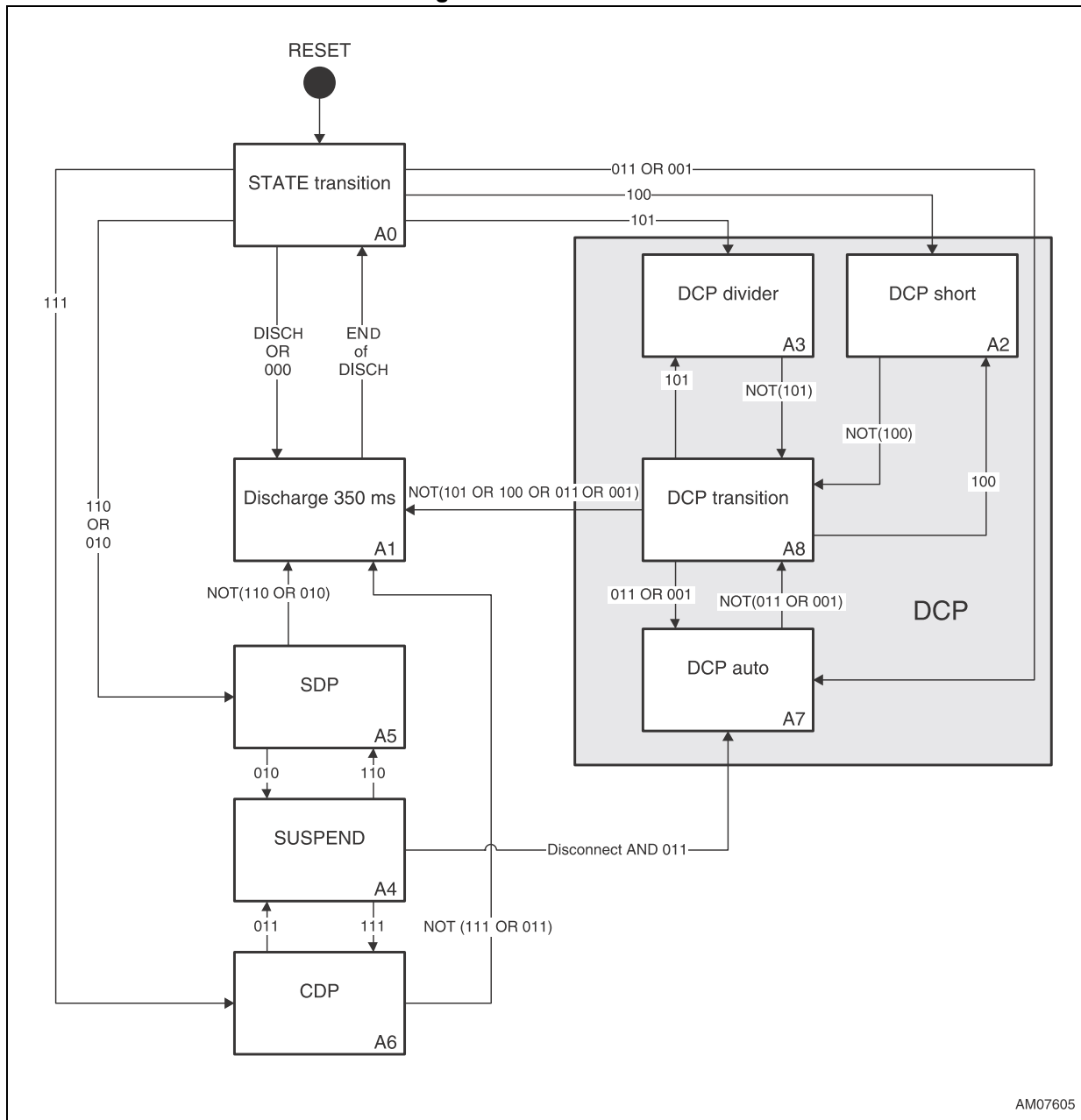

5.5 Attach detection

The STCC5011-STCC5021 can detect device attachment when the host system is in the G3 state.

The combination of logic low level on EN and logic high on ATTACH_EN enables a bypass switch, supplied by low power supply, V_{DD} (see [Table 6](#)). It allows the host to keep only low power supply LDO alive, therefore reducing its power consumption in G3 state while there is no device attached, but maintaining the possibility to wakeup. It also prevents “no charging” attached devices (“power thieves”) to draw current.

Table 6. Attach detector truth table

ATTACH_EN	EN	Attach detector
0	x	OFF
1	1	OFF
1	0	ON

The attach detection circuit has a very low consumption (12 μ A typ.) and accepts a wide supply voltage range (1.7 V up to 5.5 V).

The devices already attached before entering the G3 state (EN = 0, ATTACH_EN = 1) are ignored and their current consumption is limited to 500 μ A. Only devices attached after entering the G3 state are detected.

The attach detector monitors voltage drop across the bypass switch between V_{DD} and V_{OUT} . This voltage drop is caused either by the supply current of the attached device or by inrush current for charging device internal capacitors.

An open drain active low output $\overline{\text{CHARGING/ATTACH}}$ is asserted upon device detection, alerting the host system of device attachment. It stays asserted for the t_{ATTACH} delay (25 s typically). During this time the host may switch from G3 state to S5 state, start high power 5 V supply for V_{IN} and set proper CTLx configuration (see [Figure 6](#)).

The attached device can start charging keeping $\overline{\text{CHARGING/ATTACH}}$ asserted.

If charging doesn't occur, the flag is deasserted after the t_{ATTACH} (the attached device removed or charging current drops below threshold or safety timer expires - see [Section 5.6](#)).

Figure 6. Attach and charging detection - timing diagram

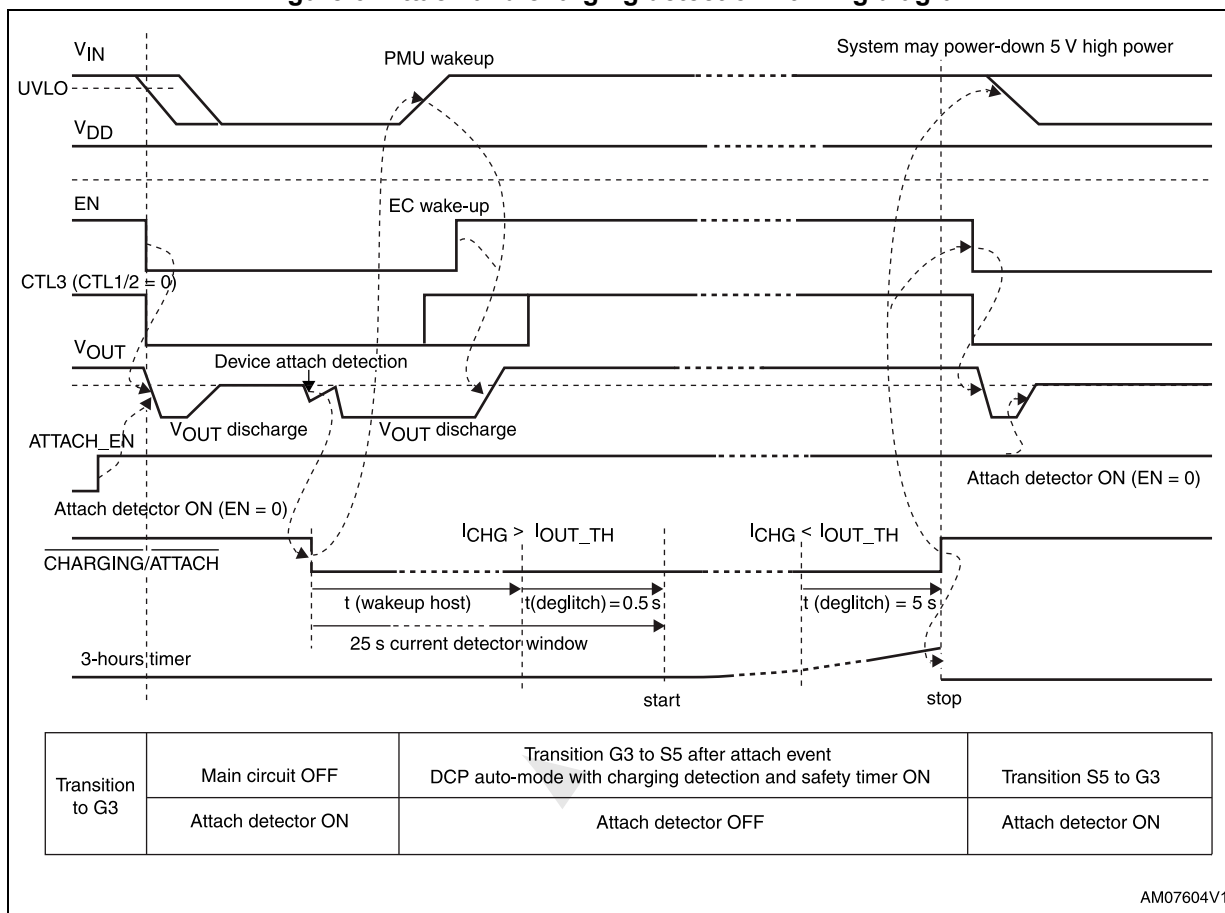

5.6 Charging detection and safety timer

The STCC5011-STCC5021 devices continuously monitor current drawn by the portable device. While programmed in CDP or DCP mode, the STCC5011-STCC5021 devices send a charging flag to the system if the current through the USB power switch is above the charging threshold, set at 20 mA typ.: open drain active low output CHARGING/ATTACH is asserted.

Note: In CDP mode the charging flag is asserted only if the CDP handshaking between the portable device and the host is performed before the current is above threshold.

If the CHARGING/ATTACH output is already asserted because of attachment detection (while the host is in G3 state), this output stays unchanged.

For systems in S5, providing current charge while being battery supplied, there is a safety timer integrated into the STCC5011-STCC5021 devices. This timer is started only after an attach event with input ATTACH_EN enabled.

The safety timer is stopped in the following conditions:

- Charging current below threshold (see *Figure 7*). The $\overline{\text{CHARGING/ATTACH}}$ output is deasserted.
- End of 3 hours (timer expires). The $\overline{\text{CHARGING/ATTACH}}$ output is deasserted.
- ATTACH_EN transition to 0 (see *Figure 8*). The $\overline{\text{CHARGING/ATTACH}}$ output is intact and the charging can continue without any time limit.

Figure 7. 3-hour timer - start and stop

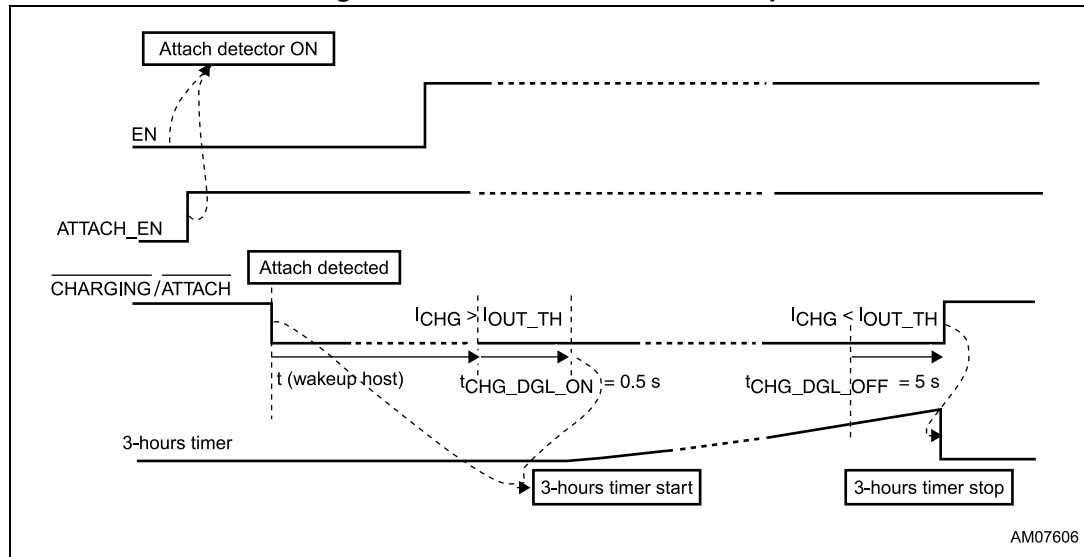
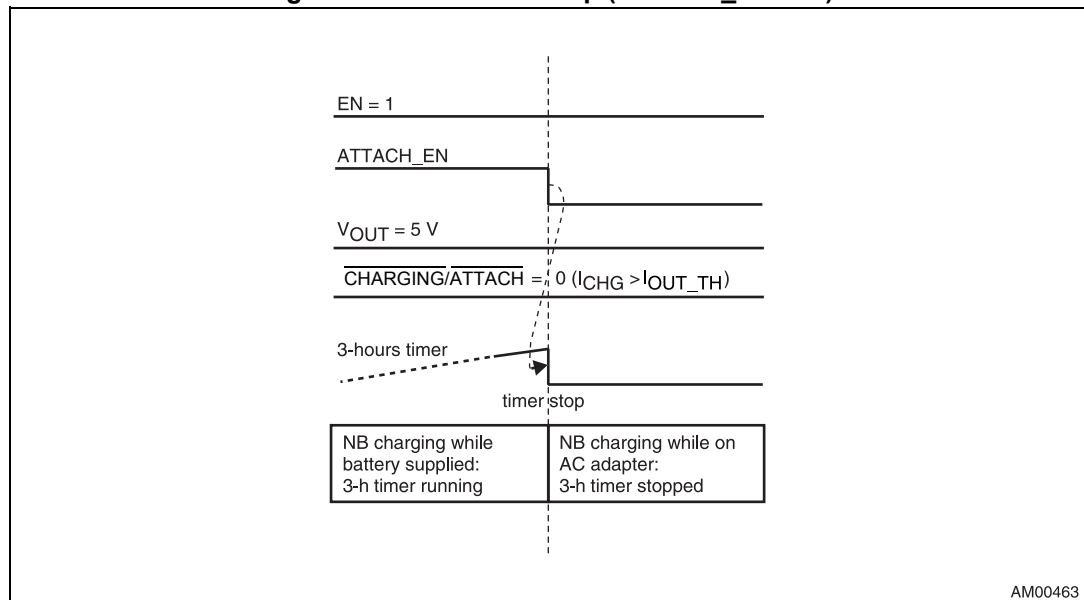

Figure 8. 3-hour timer stop (ATTACH_EN low)



Use case 1: device charging in CDP and notebook is then turned off

If a device is charging while the system is turned off and battery supplied, the risk is that the charging process stops before the end of charge due to the system power-off. To avoid this, the flag $\overline{\text{CHARGING/ATTACH}}$ can be used by the host to prevent the switching-off of the

high power DC-DC converter when the host goes to S5 state, even if battery supplied. In this case the 3-h timer is not started.

Use case 2: charging in S5, battery supplied

Once device attachment has been detected and the host has woken up, supplying V_{BUS} voltage to the portable device, the charging process can start in DCP mode. The flag CHARGING/ATTACH stays asserted for the t_{ATTACH} period (25 s typ.) after attach. During this period, the charging must be established (charging current above the I_{OUT_TH} threshold) to keep the CHARGING/ATTACH output asserted. The 3 hours safety timer is started if the ATTACH_EN is kept high.

If, for whatever reason, there is no charging current (or it is below 20 mA), CHARGING/ATTACH is deasserted (while ATTACH_EN is still high). The host can return to its previous state by switching off the high power supply, to reduce consumption, and setting the EN pin to 0. Therefore, the attach detector is ON. At this stage, the STCC5011-STCC5021 devices can detect if the device is still attached or has been removed (see Figure 9).

- If the device is still attached, the attach detector circuit waits for device removal.
- If the device is removed, the circuit goes back into attach detection mode till the next attachment.

Figure 9. Attach detection

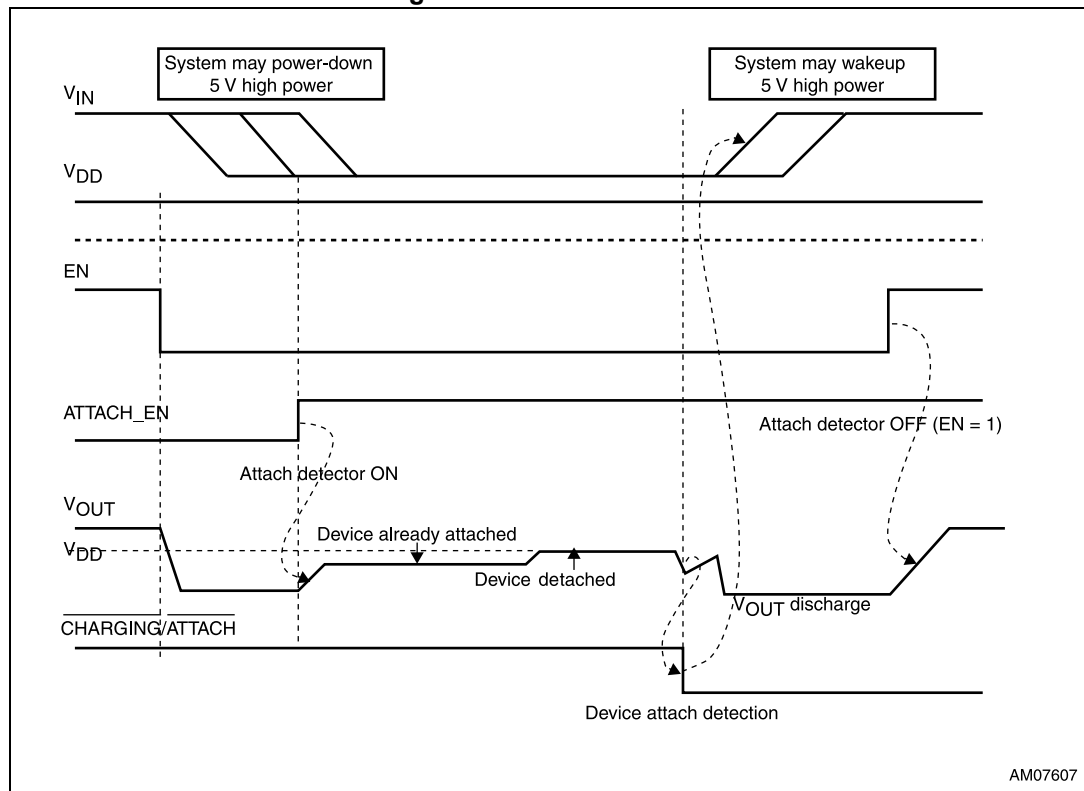
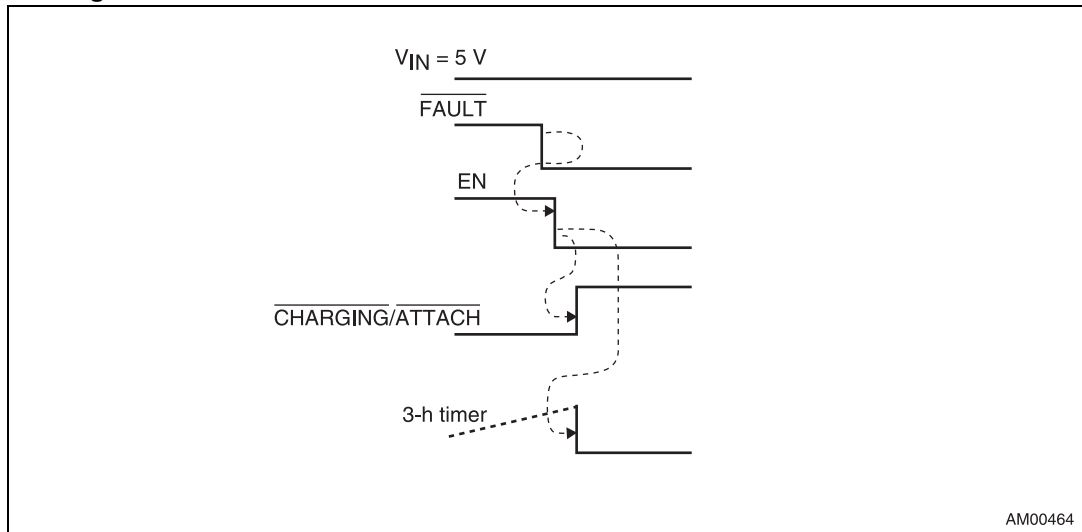

Figure 10. Reset of **CHARGING/ATTACH** and 3-hour timer after EN -> 0 event



AM00464

5.7 Power switch

Overcurrent conditions

When an overcurrent condition is detected, the device maintains a constant output current and reduces the voltage accordingly. There are two overload conditions:

- The first one occurs when a short-circuit or a partial short-circuit is already present when the device is being powered up or enabled. The output voltage is held near zero potential with respect to ground and the STCC50x1 device ramps the output current to I_{OS} until the overload condition is removed or the device starts thermal cycle.
- The second condition is when a short-circuit, a partial short-circuit, or a transient overload occurs while the device is already enabled and powered-on. The STCC50x1 device responds to overcurrent condition within time t_{IOS} . The current sense amplifier is overdriven during this time and momentarily disables the internal current limit MOSFET. It then recovers and ramps the output current to I_{OS} . Similar to the previous condition, it limits output current to I_{OS} until the overload condition is removed or thermal cycle starts.

Thermal protection

The STCC50x1 devices have an internal thermal sensing circuit which monitors the operating temperature of the circuit. It disables power switch operation if die temperature exceeds temperature threshold T_{STOP} , set at 150 °C. The thermal sensor has a hysteresis of 20 °C. The switch turns on if the temperature has cooled down by 20 °C.

Undervoltage lockout

The UVLO circuit disables the circuit until the input voltage reaches the UVLO turn-on threshold. Built-in hysteresis prevents unwanted on/off cycling due to input voltage drop during turn-on.

$\overline{\text{FAULT}}$ functionality

The $\overline{\text{FAULT}}$ open drain active low output is asserted during overcurrent or overtemperature conditions. Signal is asserted until the fault is removed.

For overcurrent conditions, the STCC50x1 device is designed to eliminate false $\overline{\text{FAULT}}$ reporting, by using an internal deglitch delay (9 ms typ.).

In the case of overtemperature, there is no deglitch delay and the $\overline{\text{FAULT}}$ signal is asserted immediately. It is deasserted with delay after the device has cooled down and begins to turn on. This unidirectional glitch immunity prevents $\overline{\text{FAULT}}$ oscillation during an overtemperature event.

In the case of fault condition, the host may disable the power switch by toggling EN input to logic low (see [Figure 10](#)).

Current limit programming

Current limit can be adjusted by an external resistor in the range 500 mA to 2.5 A (typ.). The programming resistor may be calculated using equation:

$$I_{OS} = 48000 / R_{ILIM} \text{ (mA, k}\Omega\text{)}$$

5.8 EN functionality

The enable input (EN, active high) serves to turn off the STCC50x1 device and achieve the lowest current consumption.

The behavior of the STCC50x1 device in disabled state (EN = 0) is following:

- Power switch, USB data switch and emulation profiles are turned off
- The $\overline{\text{FAULT}}$ and $\overline{\text{CHARGING/ATTACH}}$ flags are cleared (the $\overline{\text{FAULT}}$ and $\overline{\text{CHARGING/ATTACH}}$ outputs are set to Hi-Z mode)
- If ATTACH_EN = 0, permanent output discharge is turned on
- If ATTACH_EN = 1, the device turns into the attach detection mode.

5.9 Input and output capacitors

For proper functionality the STCC50x1 device requires 1 μF decoupling ceramic capacitors C_{IN} , C_{VDD} and C_{OUT} (see [Figure 4 on page 12](#)). These capacitors should be placed as close as possible to the corresponding pins.

The electrolytic capacitor C_{VBUS} (see [Figure 4](#)) is required by the USB specification to suppress the voltage and current transients caused by hot plugging/unplugging the peripheral devices. This capacitor should be placed as close as possible to the USB connector. The recommended value is 150 μF , low ESR type is preferred.

If the V_{IN} supply path is longer than approx. 150 mm, an additional capacitor is required to be connected in parallel to the C_{IN} to suppress V_{IN} overvoltage transients caused by supply path inductance and fast current changes. The minimum value is 10 μF , low ESR type is preferred.

6 Typical operating characteristics

Figure 11. Power switch ON resistance vs. temperature

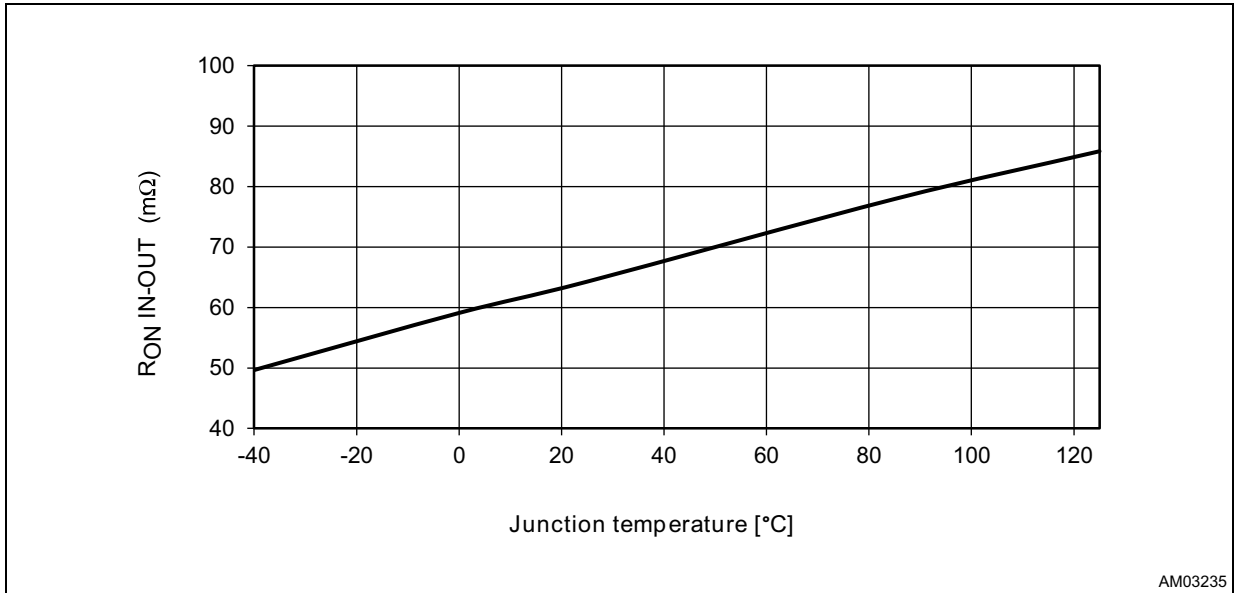

Figure 12. OUT discharge resistance vs. temperature

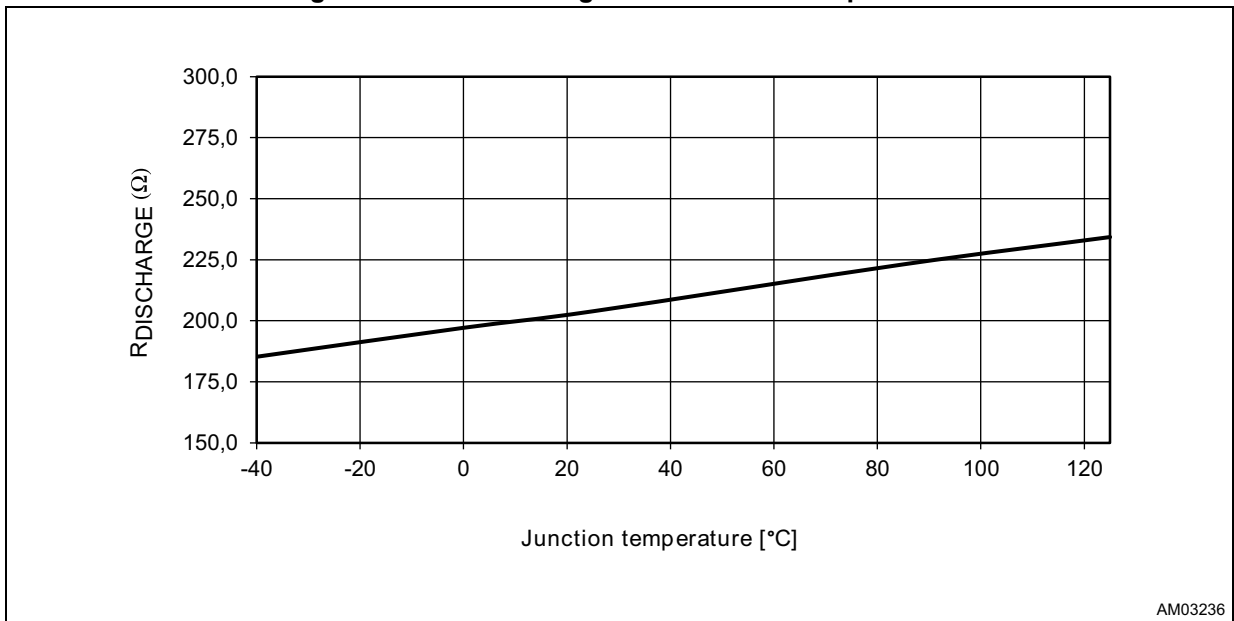

Figure 13. OUT short circuit current limit vs. temperature ($R_{LIM} = 96\text{ k}\Omega$)

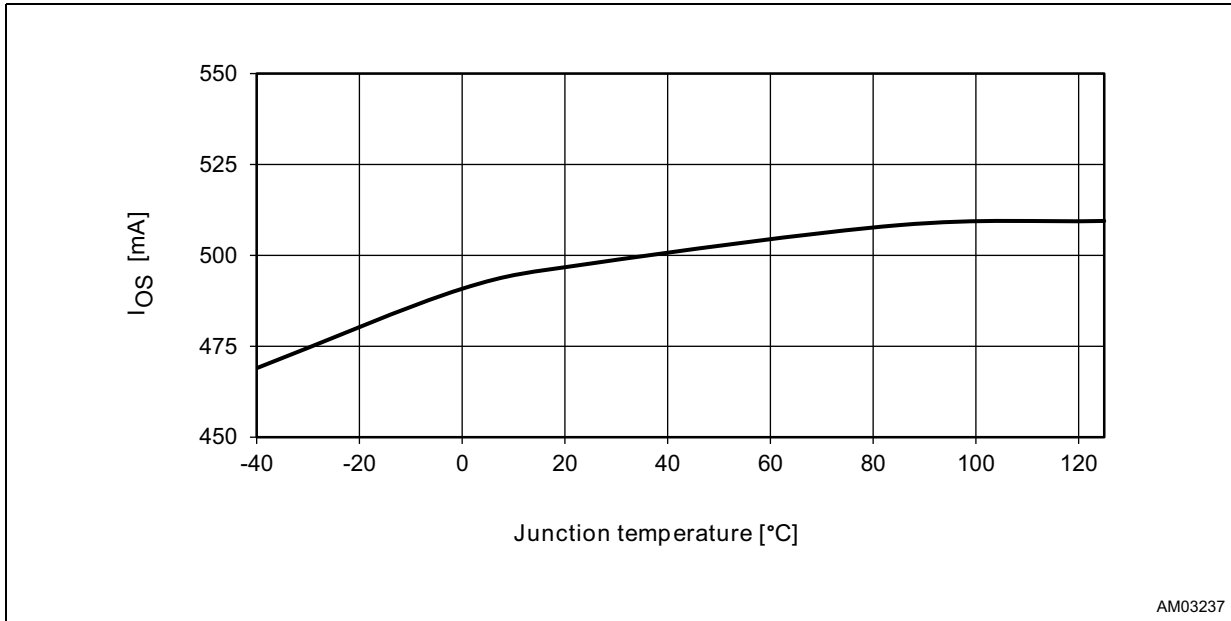

Figure 14. OUT short circuit current limit vs. temperature ($R_{LIM} = 33\text{ k}\Omega$)

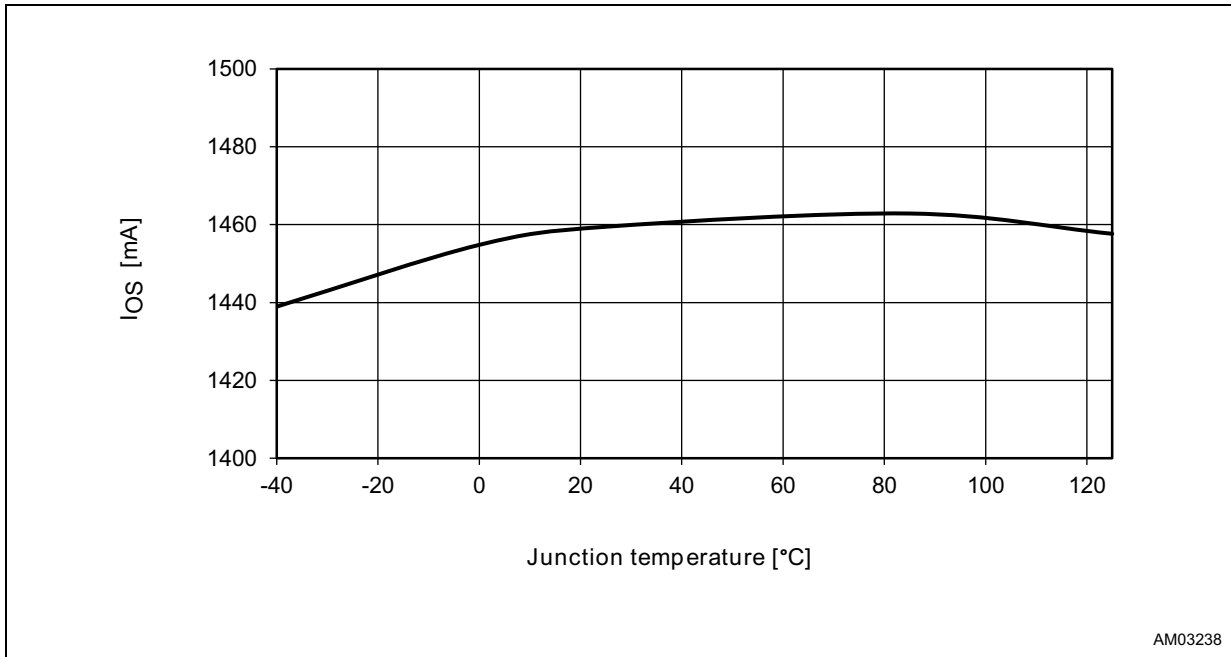

Figure 15. OUT short circuit current limit vs. temperature ($R_{LIM} = 19.6\text{ k}\Omega$)

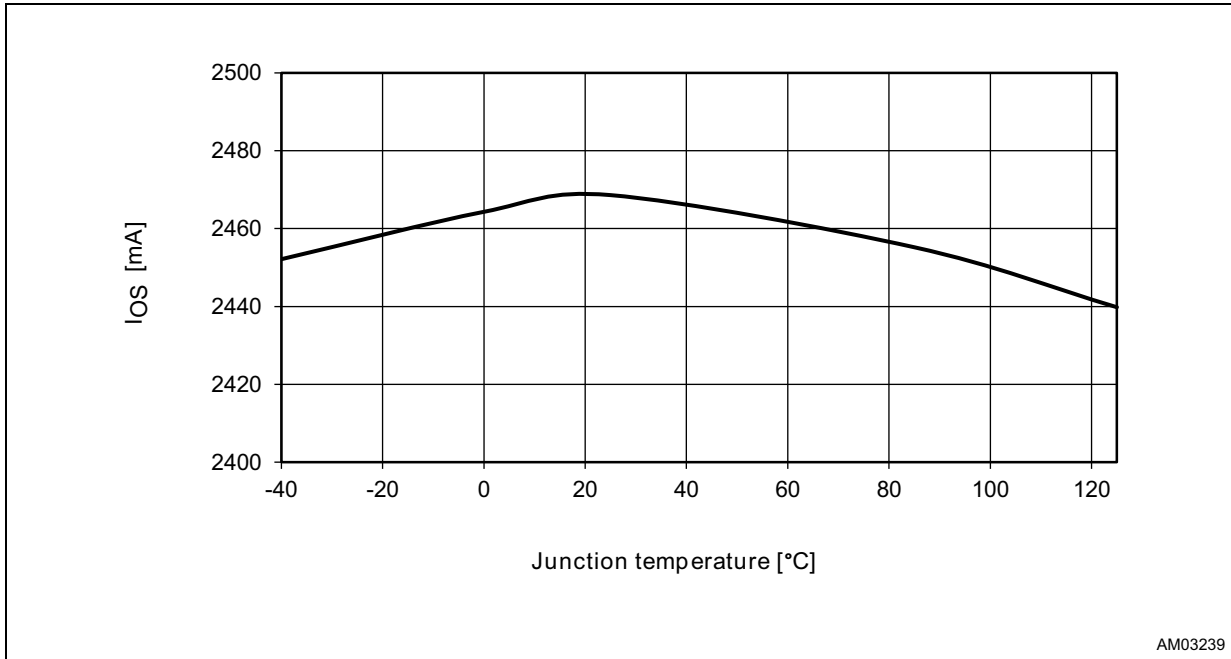

Figure 16. Disabled IN supply current vs. temperature

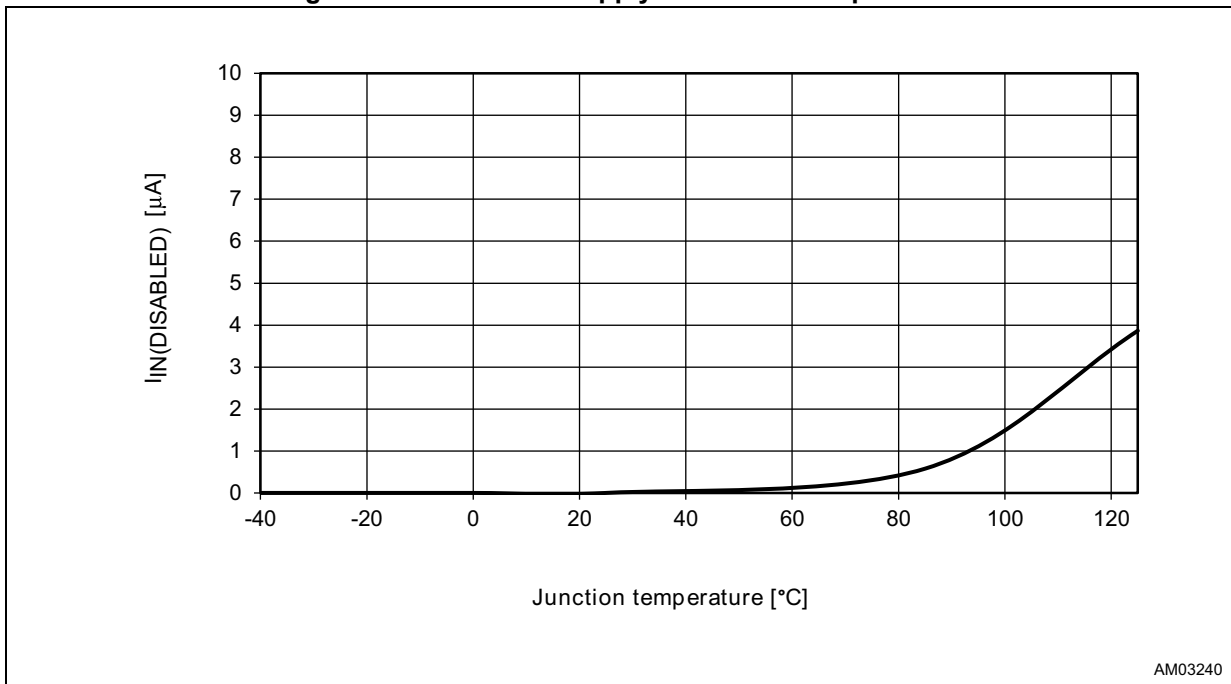

Figure 17. Enabled IN supply current vs. temperature (SDP mode)

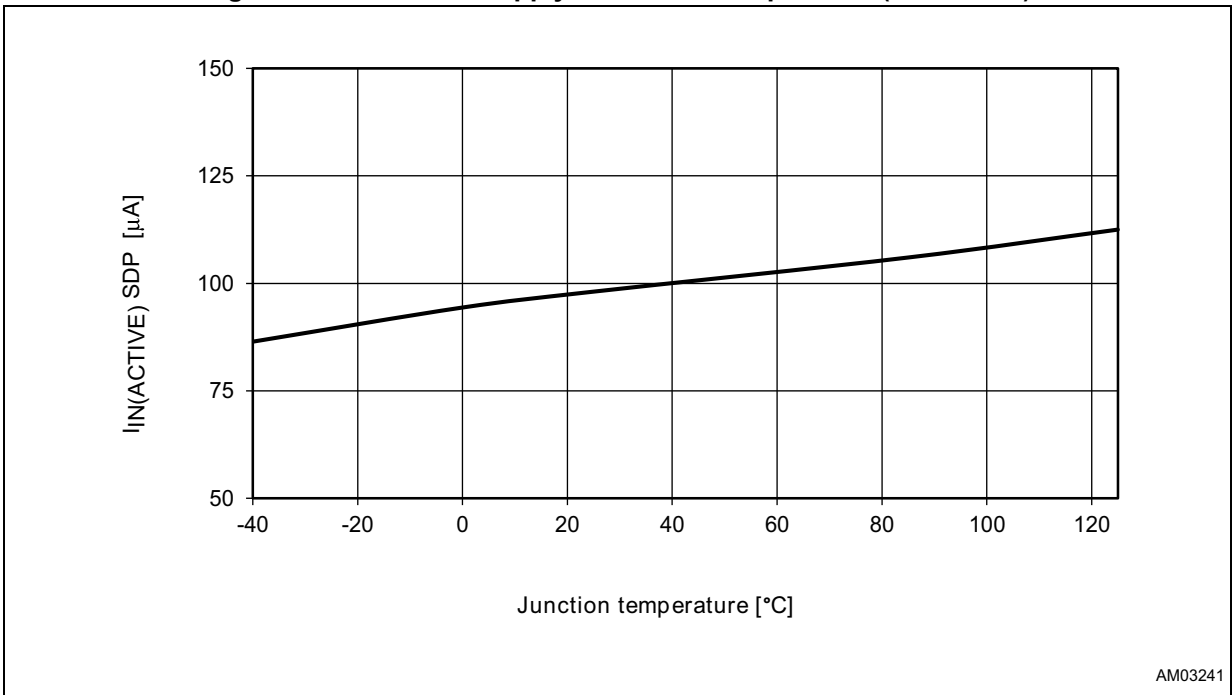

Figure 18. Enabled IN supply current vs. temperature (CDP mode)

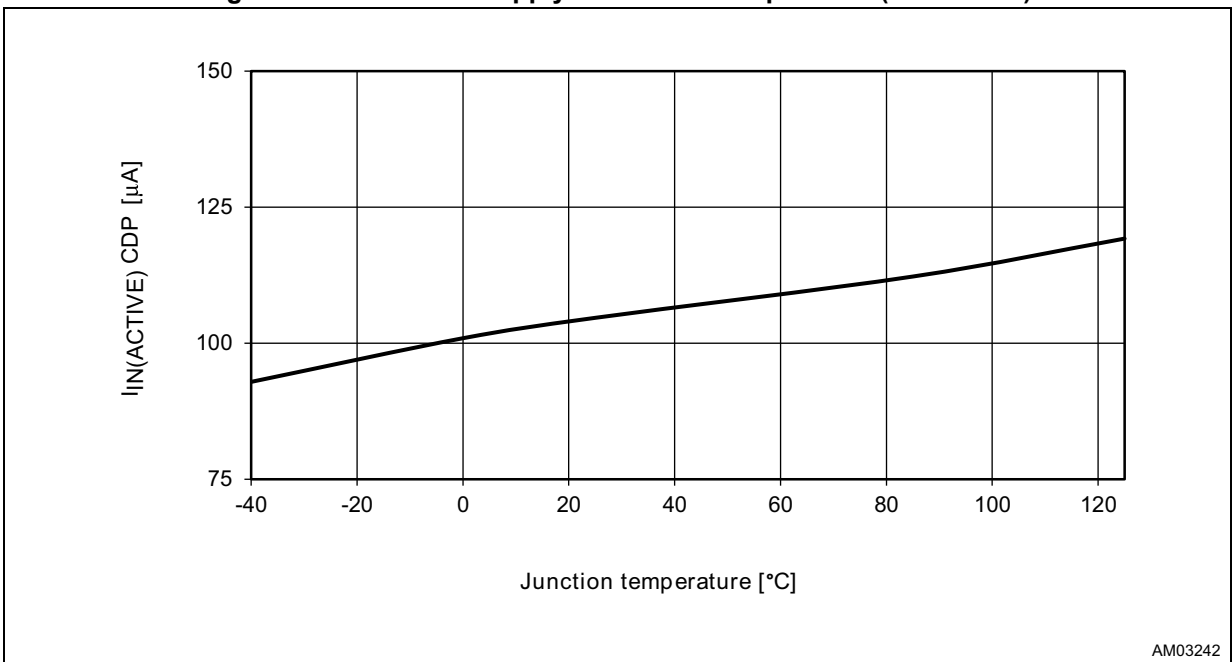

Figure 19. Enabled IN supply current vs. temperature (DCP auto-mode)

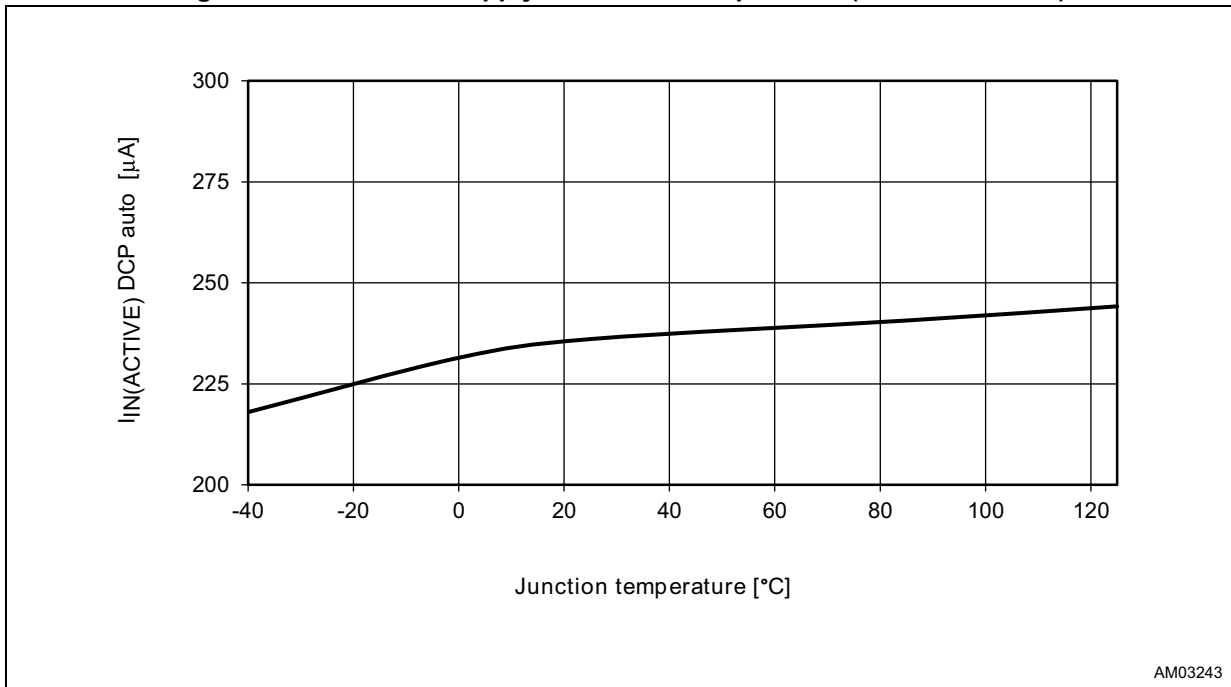

Figure 20. Enabled IN supply current vs. temperature (DCP BC1.2 mode)

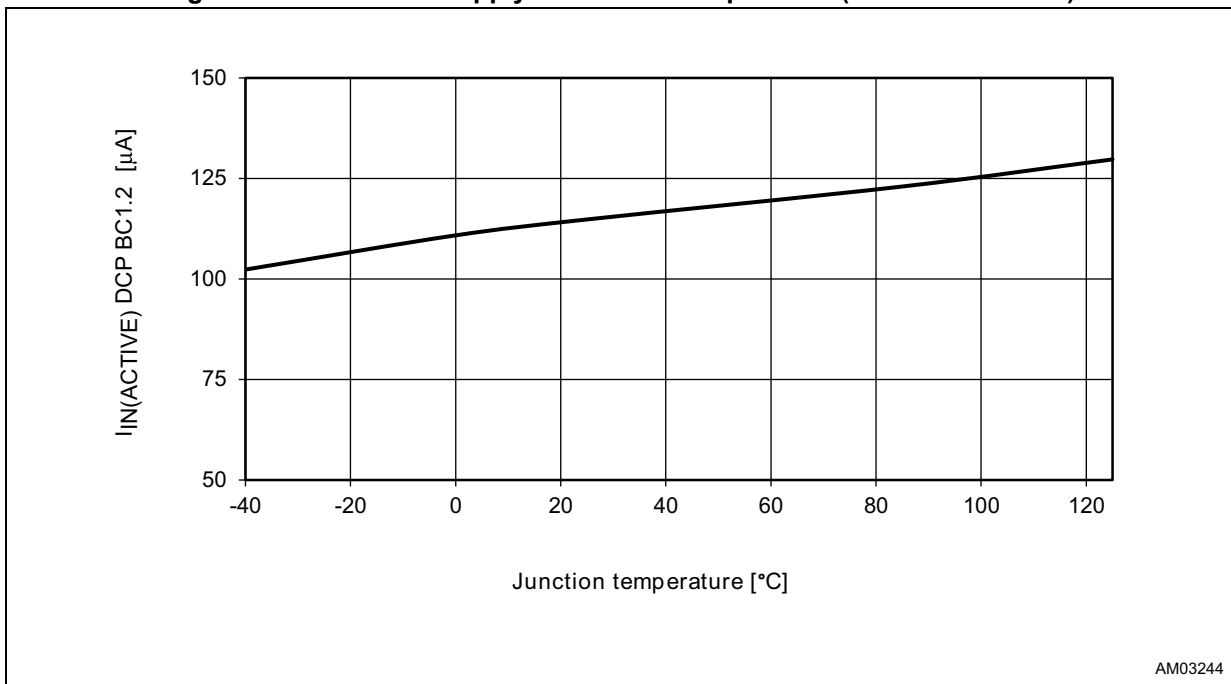
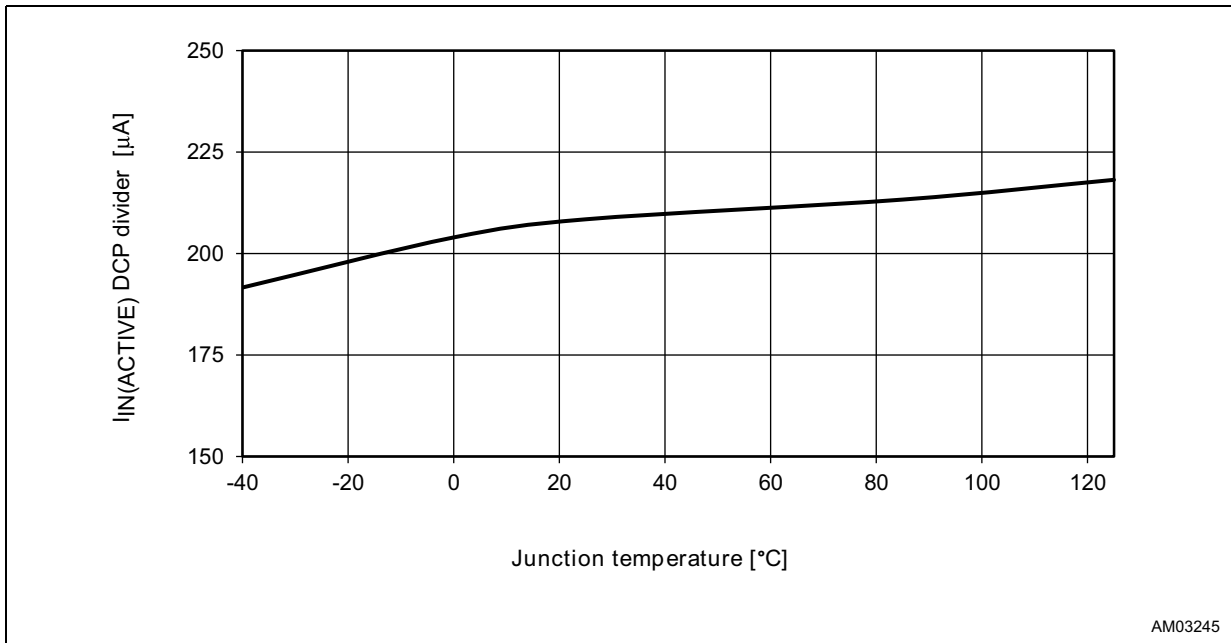

Figure 21. Enabled IN supply current vs. temperature (DCP divider mode)



AM03245

Figure 22. Data switch transfer characteristics vs. frequency



Figure 23. Eye diagram using USB compliance test pattern - without STCC50x1 (deskew line + cable)

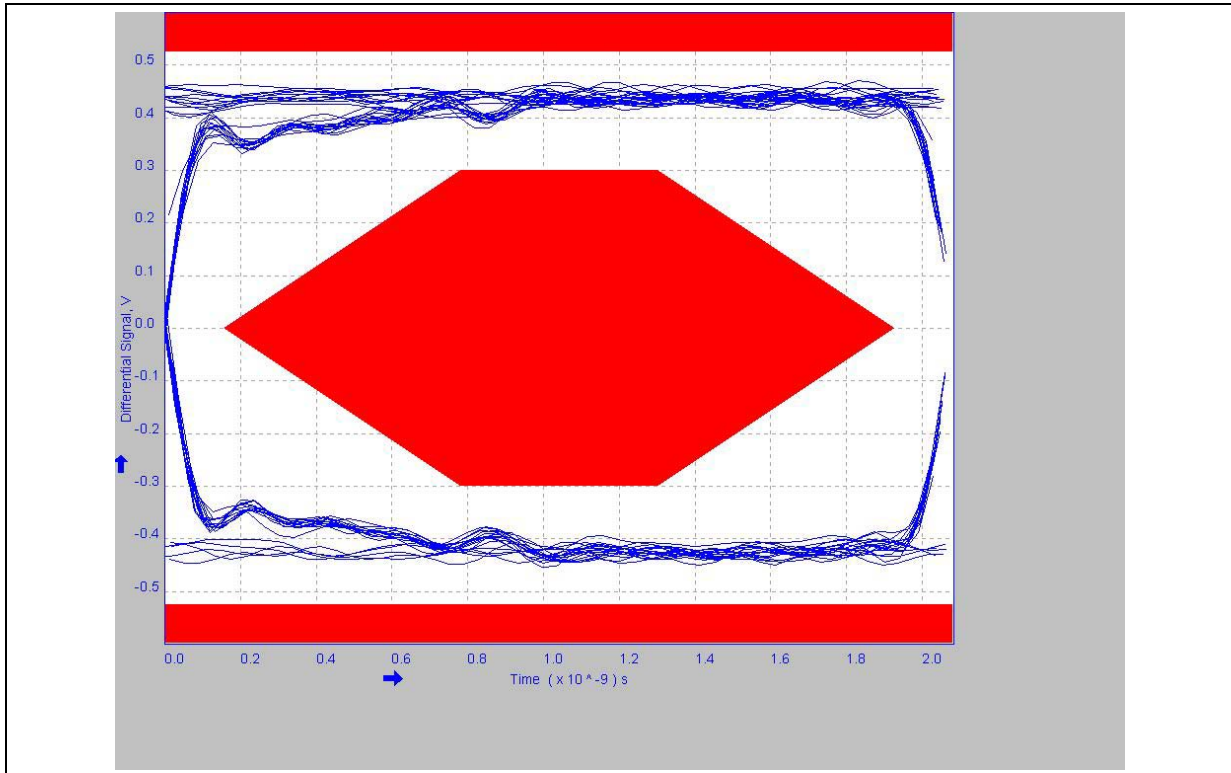

Figure 24. Eye diagram using USB compliance test pattern - with STCC50x1 (STCC50x1 + cable)

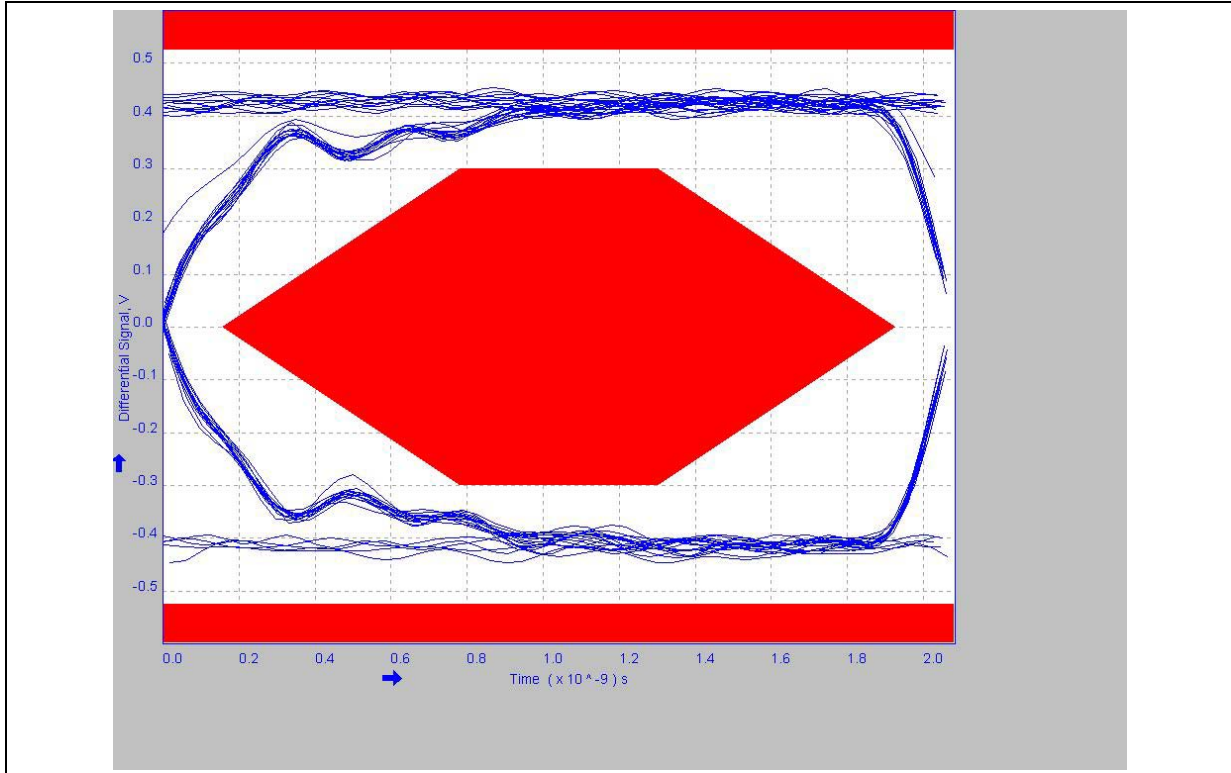

Figure 25. Turn-on response ($R_{LIM} = 20\text{ k}\Omega$, $R_{LOAD} = 5\ \Omega$, $C_{LOAD} = 150\ \mu\text{F}$)

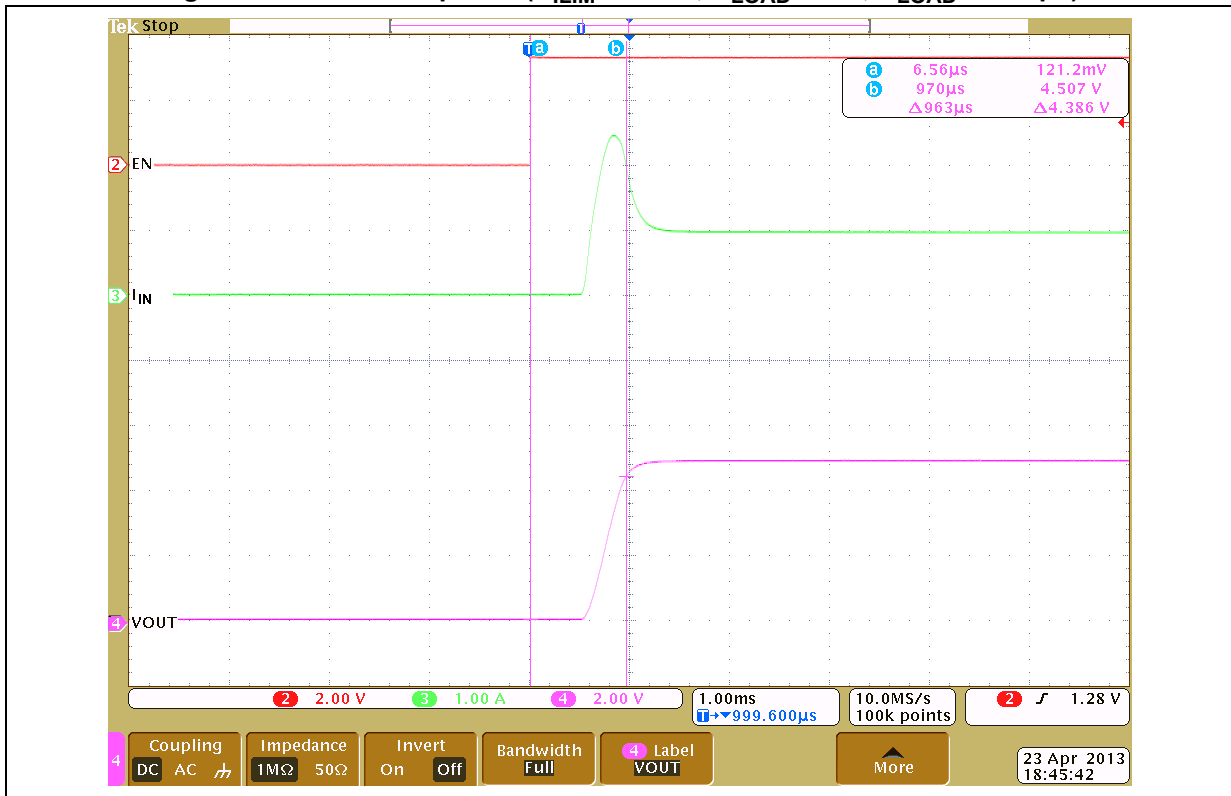

Figure 26. Turn-off response ($R_{LOAD} = 5\ \Omega$, $C_{LOAD} = 150\ \mu\text{F}$)

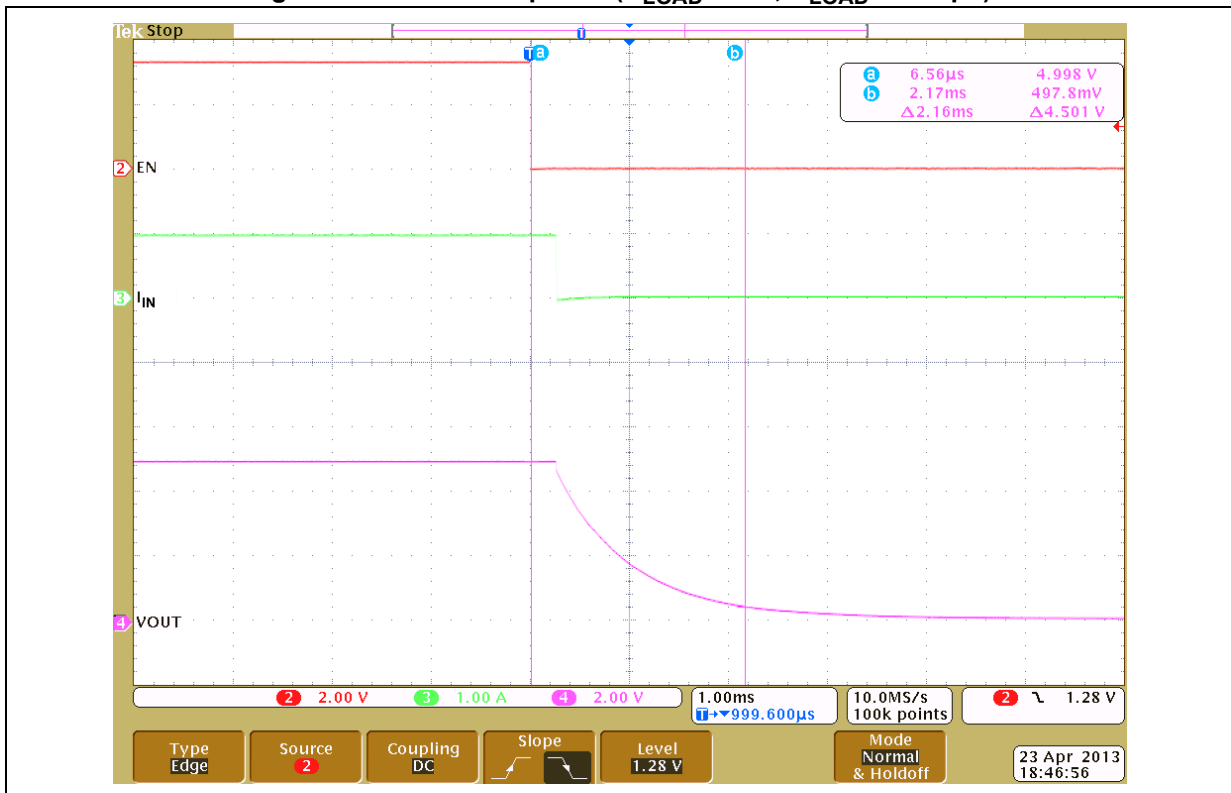

Figure 27. Device enabled into short-circuit ($R_{ILIM} = 80.6 \text{ k}\Omega$)

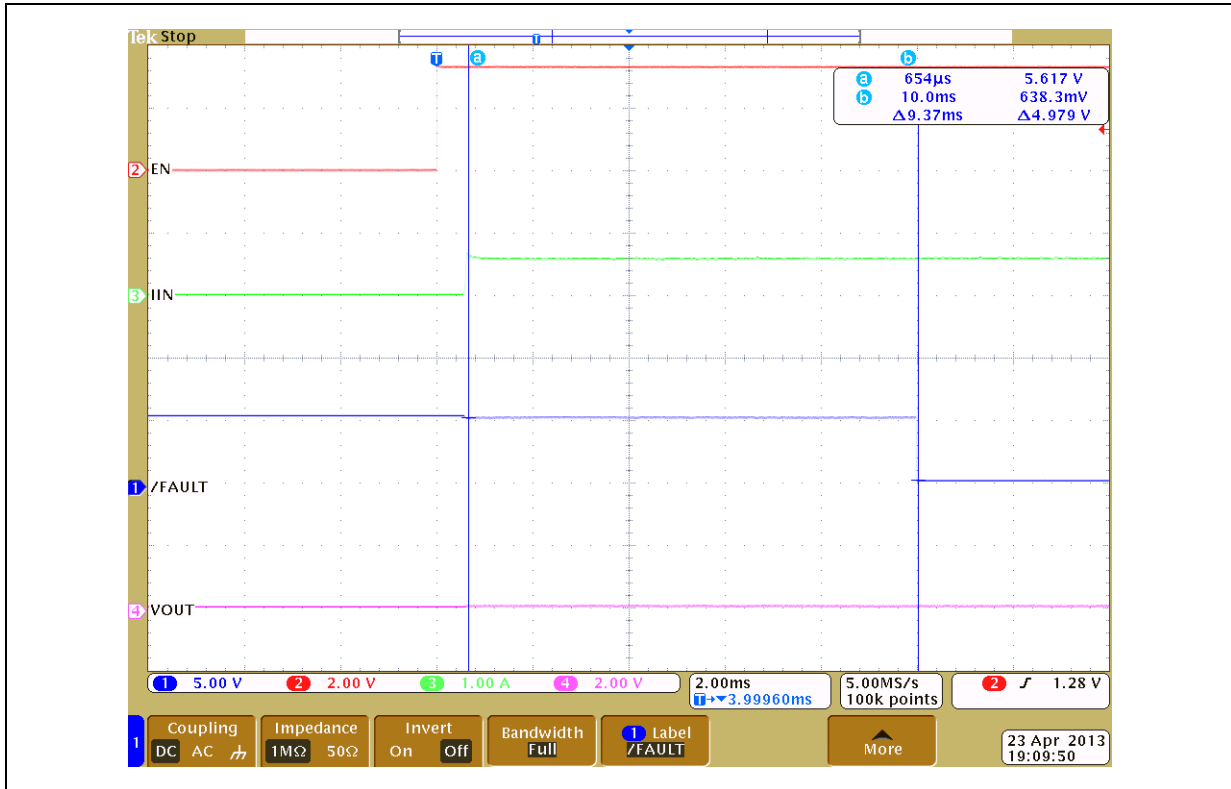

Figure 28. Device enabled into short-circuit - thermal cycling ($R_{ILIM} = 20 \text{ k}\Omega$)

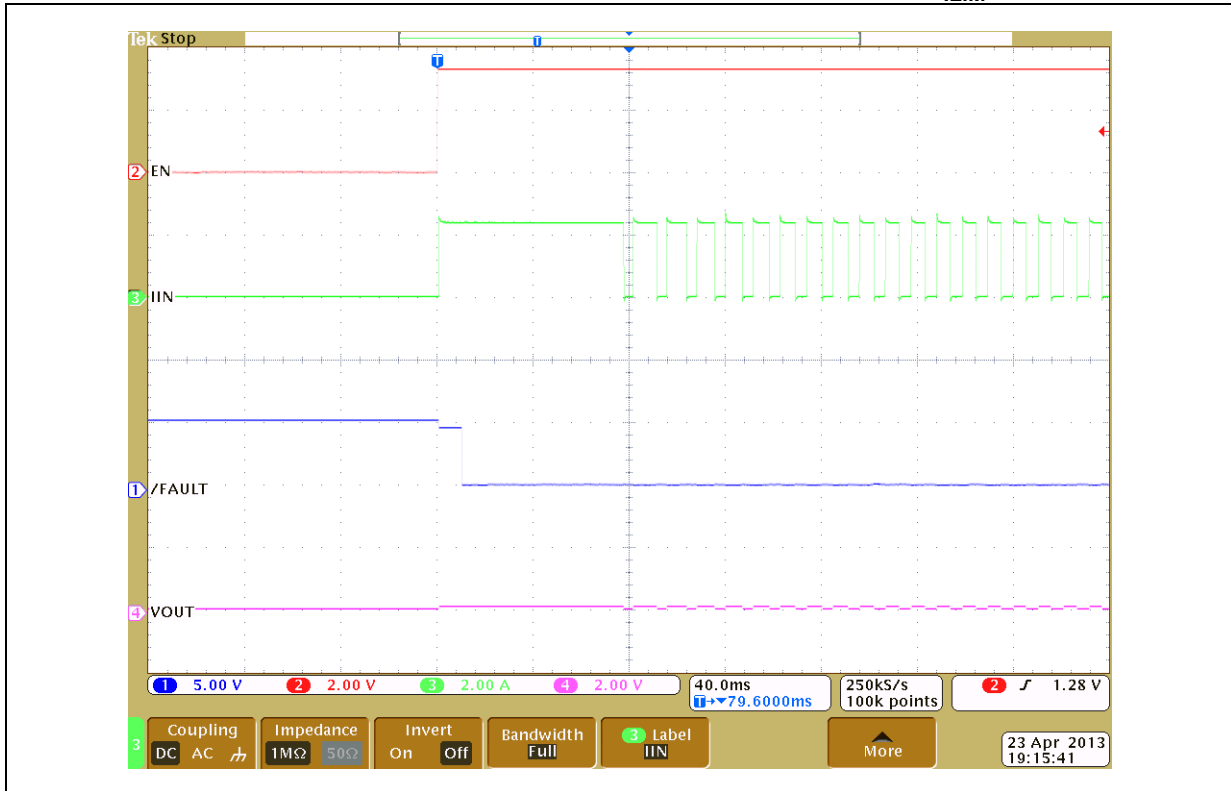
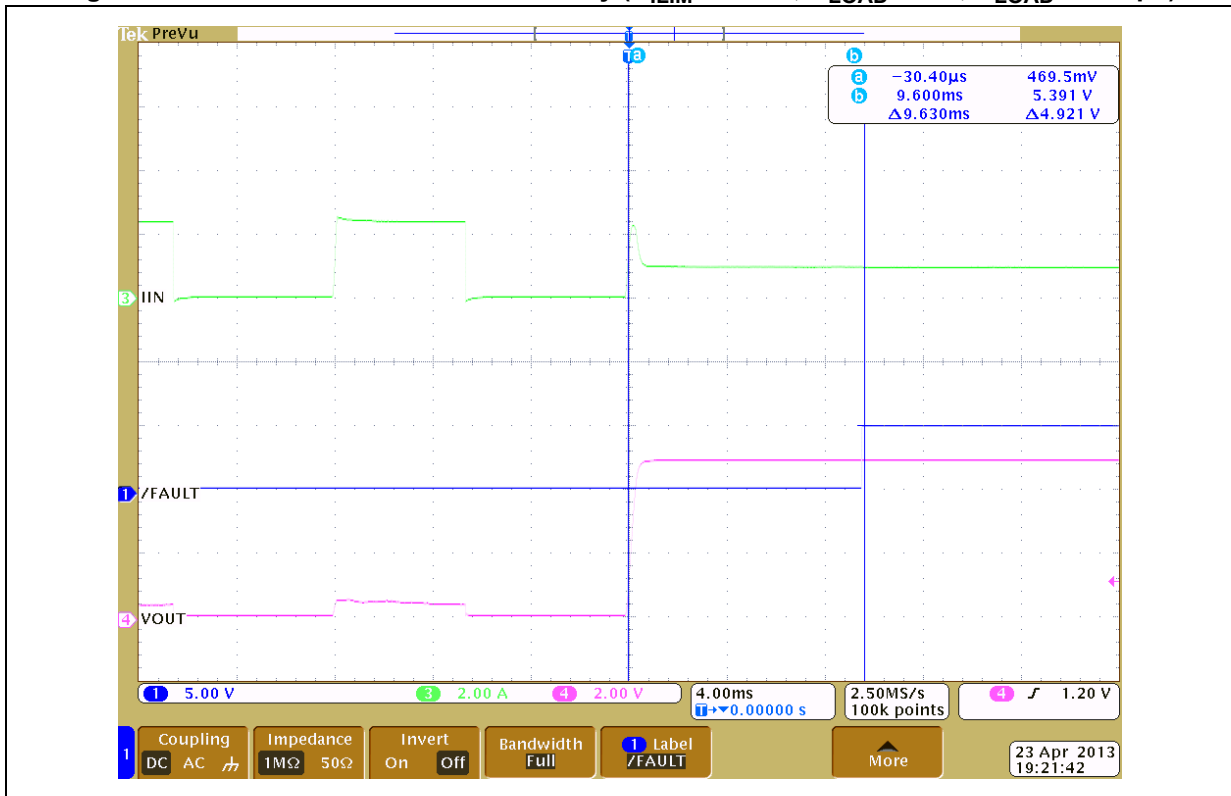

Figure 29. Short-circuit to full load recovery ($R_{ILIM} = 20\text{ k}\Omega$, $R_{LOAD} = 5\ \Omega$, $C_{LOAD} = 150\ \mu\text{F}$)



7 Package information

In order to meet environmental requirements, ST offers these devices in different grades of ECOPACK® packages, depending on their level of environmental compliance. ECOPACK specifications, grade definitions and product status are available at: www.st.com. ECOPACK is an ST trademark.

Figure 30. VFQFPN 16L - 3 x 3 x 0.8 mm with exposed pad 1.7 - package outline

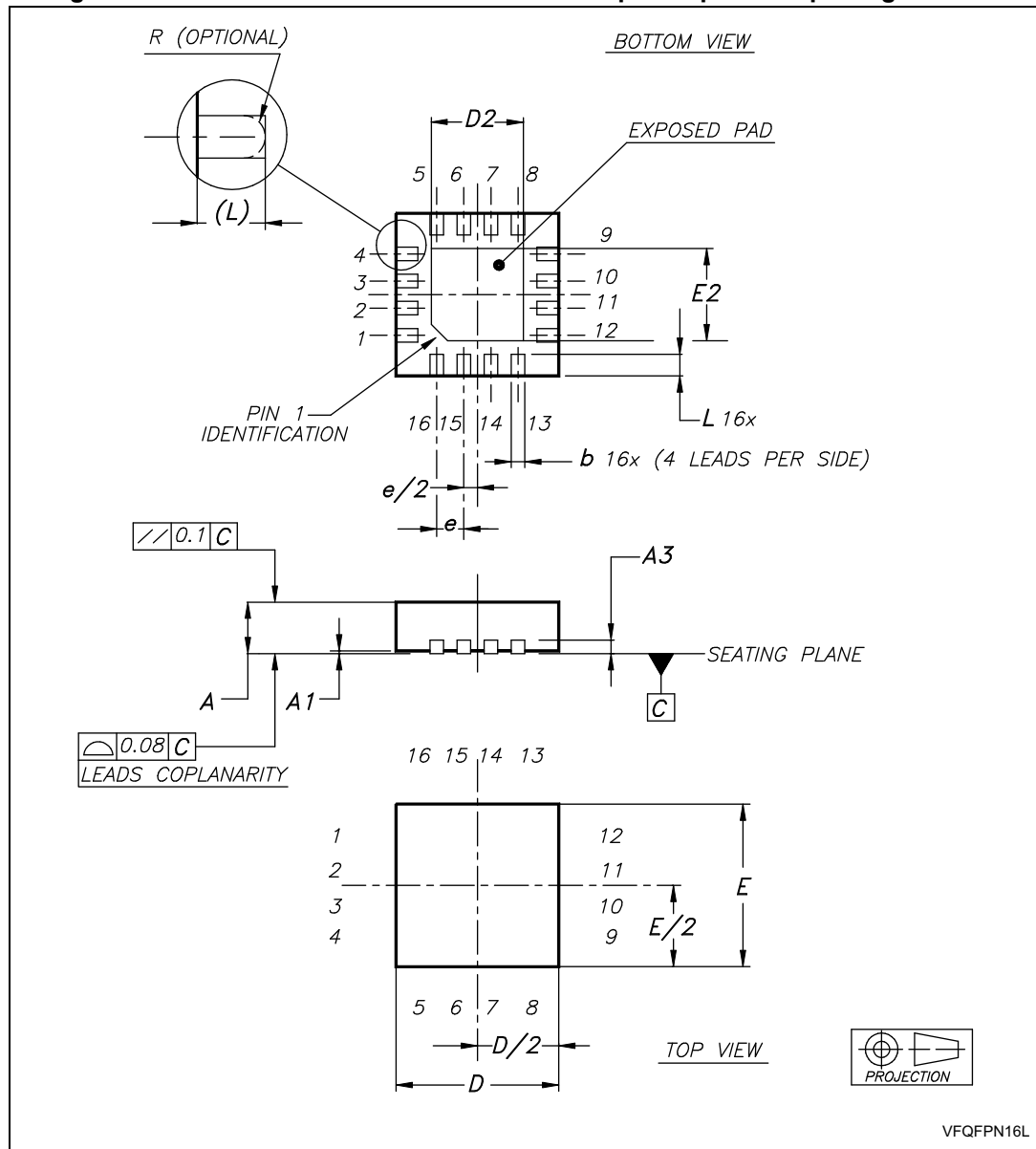
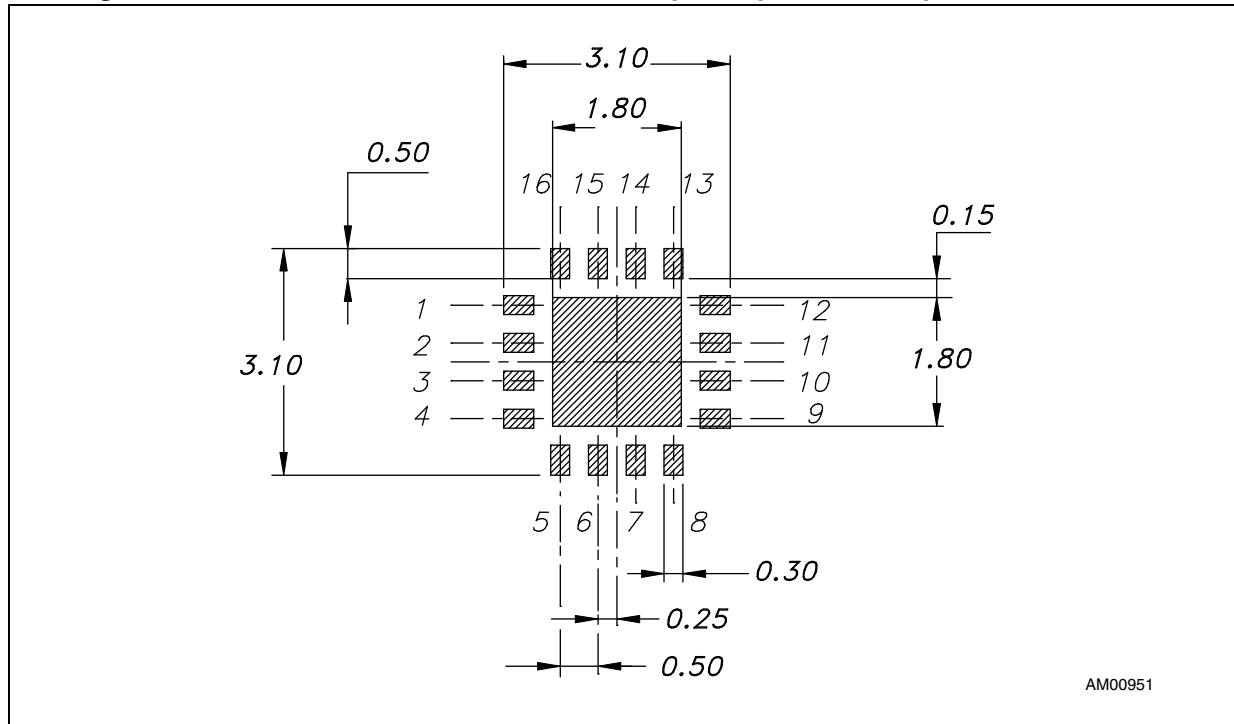

Table 7. VFQFPN 16L - 3 x 3 x 0.8 mm with exposed pad 1.7 - package mechanical data^{(1), (2), (3), (4)}

Symbol	Dimensions			Notes
	Data book (mm)			
	Nom.	Min.	Max.	
A	0.75	0.70	0.80	
A1	0.02	0	0.05	
A3	0.20			
b	0.25	0.18	0.30	
D	3	2.90	3.10	
D2	1.70	1.50	1.80	
E	3	2.90	3.10	
E2	1.70	1.50	1.80	
e	0.50			
L	0.40	0.30	0.50	(5)

1. VFQFPN - standard for "thermally enhanced very thin fine pitch quad flat package no leads".
2. The lead size is comprehensive of the thickness of the lead finishing material.
3. Dimensions do not include mold protrusion, not to exceed 0.15 mm.
4. Package outline exclusive of metal burr dimensions.
5. The value of "L" a JEDEC norm is min. 0.35 – max. 0.45.

Figure 31. VFQFPN 16L - 3 x 3 x 0.8 mm with exposed pad 1.7 - footprint recommended



8 Ordering information

Table 8. Order codes

Part number	Apple divider mode	Temperature range	Package	Packaging
STCC5011IQTR	1 A	-40 to 85 °C	VFQFPN 16L	Tape and reel
STCC5021IQTR	2 A			

9 Revision history

Table 9. Document revision history

Date	Revision	Changes
20-May-2013	1	Initial release.
24-Jun-2013	2	<p>Updated Features on page 1 (added UL and CB recognized components).</p> <p>Updated note 3. below Table 2 (updated data, added cross-reference to Figure 4).</p> <p>Updated Table 4 (updated parameters and conditions to $I_{REVERSE}$, $I_{OL(\overline{FAULT})}$, $I_{OL(\overline{CHARGING/ATTACH})}$, I_{CTLX}, $I_{OL(\overline{CHARGING/ATTACH})}$ symbols, added I_{ATTACH_EN} symbol).</p> <p>Added Figure 4 on page 12.</p> <p>Added Note: in Section 5.1 on page 13.</p> <p>Added Section 5.9 on page 21.</p>

Please Read Carefully:

Information in this document is provided solely in connection with ST products. STMicroelectronics NV and its subsidiaries ("ST") reserve the right to make changes, corrections, modifications or improvements, to this document, and the products and services described herein at any time, without notice.

All ST products are sold pursuant to ST's terms and conditions of sale.

Purchasers are solely responsible for the choice, selection and use of the ST products and services described herein, and ST assumes no liability whatsoever relating to the choice, selection or use of the ST products and services described herein.

No license, express or implied, by estoppel or otherwise, to any intellectual property rights is granted under this document. If any part of this document refers to any third party products or services it shall not be deemed a license grant by ST for the use of such third party products or services, or any intellectual property contained therein or considered as a warranty covering the use in any manner whatsoever of such third party products or services or any intellectual property contained therein.

UNLESS OTHERWISE SET FORTH IN ST'S TERMS AND CONDITIONS OF SALE ST DISCLAIMS ANY EXPRESS OR IMPLIED WARRANTY WITH RESPECT TO THE USE AND/OR SALE OF ST PRODUCTS INCLUDING WITHOUT LIMITATION IMPLIED WARRANTIES OF MERCHANTABILITY, FITNESS FOR A PARTICULAR PURPOSE (AND THEIR EQUIVALENTS UNDER THE LAWS OF ANY JURISDICTION), OR INFRINGEMENT OF ANY PATENT, COPYRIGHT OR OTHER INTELLECTUAL PROPERTY RIGHT.

ST PRODUCTS ARE NOT AUTHORIZED FOR USE IN WEAPONS. NOR ARE ST PRODUCTS DESIGNED OR AUTHORIZED FOR USE IN: (A) SAFETY CRITICAL APPLICATIONS SUCH AS LIFE SUPPORTING, ACTIVE IMPLANTED DEVICES OR SYSTEMS WITH PRODUCT FUNCTIONAL SAFETY REQUIREMENTS; (B) AERONAUTIC APPLICATIONS; (C) AUTOMOTIVE APPLICATIONS OR ENVIRONMENTS, AND/OR (D) AEROSPACE APPLICATIONS OR ENVIRONMENTS. WHERE ST PRODUCTS ARE NOT DESIGNED FOR SUCH USE, THE PURCHASER SHALL USE PRODUCTS AT PURCHASER'S SOLE RISK, EVEN IF ST HAS BEEN INFORMED IN WRITING OF SUCH USAGE, UNLESS A PRODUCT IS EXPRESSLY DESIGNATED BY ST AS BEING INTENDED FOR "AUTOMOTIVE, AUTOMOTIVE SAFETY OR MEDICAL" INDUSTRY DOMAINS ACCORDING TO ST PRODUCT DESIGN SPECIFICATIONS. PRODUCTS FORMALLY ESCC, QML OR JAN QUALIFIED ARE DEEMED SUITABLE FOR USE IN AEROSPACE BY THE CORRESPONDING GOVERNMENTAL AGENCY.

Resale of ST products with provisions different from the statements and/or technical features set forth in this document shall immediately void any warranty granted by ST for the ST product or service described herein and shall not create or extend in any manner whatsoever, any liability of ST.

ST and the ST logo are trademarks or registered trademarks of ST in various countries.

Information in this document supersedes and replaces all information previously supplied.

The ST logo is a registered trademark of STMicroelectronics. All other names are the property of their respective owners.

© 2013 STMicroelectronics - All rights reserved

STMicroelectronics group of companies

Australia - Belgium - Brazil - Canada - China - Czech Republic - Finland - France - Germany - Hong Kong - India - Israel - Italy - Japan - Malaysia - Malta - Morocco - Philippines - Singapore - Spain - Sweden - Switzerland - United Kingdom - United States of America

www.st.com

