

CMOS Low-Power Monostable/Astable Multivibrator

High Voltage Types (20-Volt Rating)

■ CD4047B consists of a gatatable astable multivibrator with logic techniques incorporated to permit positive or negative edge-triggered monostable multivibrator action with retriggering and external counting options.

Inputs include +TRIGGER, -TRIGGER, ASTABLE, REASSERT, RETRIGGER, and EXTERNAL RESET. Buffered outputs are Q, Q-bar, and OSCILLATOR. In all modes of operation, and external capacitor must be connected between C-Timing and RC-Common terminals, and an external resistor must be connected between the R-Timing and RC-Common terminals.

Astable operation is enabled by a high level on the ASTABLE input or a low level on the REASSERT input, or both. The period of the square wave at the Q and Q-bar Outputs in this mode of operation is a function of the external components employed. "True" input pulses on the ASTABLE input or "Complement" pulses on the REASSERT input allow the circuit to be used as a gatatable multivibrator. The OSCILLATOR output period will be half of the Q terminal output in the astable mode. However, a 50% duty cycle is not guaranteed at this output.

The CD4047B triggers in the monostable mode when a positive-going edge occurs on the + TRIGGER-input while the -TRIGGER is held low. Input pulses may be of any duration relative to the output pulse.

If retrigger capability is desired, the RETRIGGER input is pulsed. The retriggerable mode of operation is limited to positive-going edge. The CD4047B will retrigger as long as the RETRIGGER-input is high, with or without transitions (See Fig. 34).

An external countdown option can be implemented by coupling "Q" to an external "N" counter and resetting the counter with the trigger pulse. The counter output pulse is fed back to the ASTABLE input and has a duration equal to N times the period of the multivibrator.

A high level on the EXTERNAL RESET input assures no output pulse during an "ON" power condition. This input can also be activated to terminate the output pulse at any time. For monostable operation, whenever V_{DD} is applied, an internal power-on reset circuit will clock the Q output low within one output period (t_M).

The CD4047B-Series types are supplied in 14-lead hermetic dual-in-line ceramic packages (F3A suffix), 14-lead dual-in-line plastic packages (E suffix), 14-lead small-outline packages (M, MT, M96, and NSR suffixes), and 14-lead thin shrink small-outline packages (PW and PWR suffixes).

Features:

- Low power consumption: special CMOS oscillator configuration
- Monostable (one-shot) or astable (free-running) operation
- True and complemented buffered outputs
- Only one external R and C required
- Buffered inputs
- 100% tested for quiescent current at 20 V
- Standardized, symmetrical output characteristics
- 5-V, 10-V, and 15-V parametric ratings
- Meets all requirements of JEDEC Tentative Standard No. 13B, "Standard Specifications for Description of 'B' Series CMOS Devices"

Monostable Multivibrator Features:

- Positive- or negative-edge trigger
- Output pulse width independent of trigger pulse duration
- Retriggerable option for pulse width expansion
- Internal power-on reset circuit
- Long pulse widths possible using small RC components by means of external counter provision
- Fast recovery time essentially independent of pulse width
- Pulse-width accuracy maintained at duty cycles approaching 100%

Astable Multivibrator Features:

- Free-running or gatatable operating modes
- 50% duty cycle

- Oscillator output available
- Good astable frequency stability:
Frequency deviation:
= ± 2% + 0.03%/°C @ 100 kHz
= ± 0.5% + 0.015%/°C @ 10 kHz
(circuits "trimmed" to frequency V_{DD} = 10 V ± 10%)

Applications:

Digital equipment where low-power dissipation and/or high noise immunity are primary design requirements:

- Envelope detection
- Frequency multiplication
- Frequency division
- Frequency discriminators
- Timing circuits
- Time-delay applications

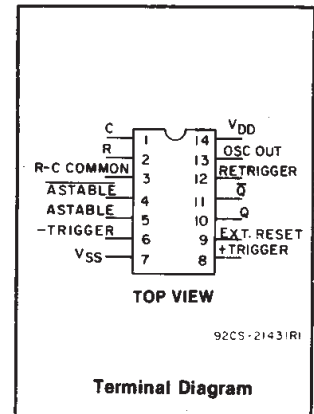

RECOMMENDED OPERATING CONDITIONS

For maximum reliability, nominal operating conditions should be selected so that operation is always within the following ranges:

CHARACTERISTIC	LIMITS		UNITS
	MIN.	MAX.	
Supply-Voltage Range (For T _A = Full Package-Temperature Range)	3	18	V

NOTE: IF AT 15 V OPERATION A 10 MΩ RESISTOR IS USED THE OPERATING TEMPERATURE SHOULD BE BETWEEN -25°C and 100°C

MAXIMUM RATINGS, Absolute-Maximum Values:

DC SUPPLY-VOLTAGE RANGE, (V _{DD}) Voltages referenced to V _{SS} Terminal	-0.5V to +20V
INPUT VOLTAGE RANGE, ALL INPUTS	-0.5V to V _{DD} + 0.5V
DC INPUT CURRENT, ANY ONE INPUT	±10mA
POWER DISSIPATION PER PACKAGE (P _D): For T _A = -55°C to +100°C	500mW
For T _A = +100°C to +125°C	Derate Linearly at 12mW/°C to 200mW
DEVICE DISSIPATION PER OUTPUT TRANSISTOR FOR T _A = FULL PACKAGE-TEMPERATURE RANGE (All Package Types)	100mW
OPERATING-TEMPERATURE RANGE (T _A)	-55°C to +125°C
STORAGE TEMPERATURE RANGE (T _{stg})	-65°C to +150°C
LEAD TEMPERATURE (DURING SOLDERING): At distance 1/16 ± 1/32 inch (1.59 ± 0.79mm) from case for 10s max	+265°C

CD4047B Types

CD4047B FUNCTIONAL TERMINAL CONNECTIONS

NOTE: IN ALL CASES EXTERNAL RESISTOR BETWEEN TERMINALS 2 AND 3▲
EXTERNAL CAPACITOR BETWEEN TERMINALS 1 AND 3▲

FUNCTION	TERMINAL CONNECTIONS			OUTPUT PULSE FROM	OUTPUT PERIOD OR PULSE WIDTH
	TO V _{DD}	TO V _{SS}	INPUT TO		
Astable Multivibrator: Free Running	4,5,6,14	7,8,9,12	—	10,11,13	$t_A(10,11) = 4.40 RC$
True Gating	4,6,14	7,8,9,12	5	10,11,13	$t_A(13) = 2.20 RC^*$
Complement Gating	6,14	5,7,8,9,12	4	10,11,13	
Monostable Multivibrator: Positive-Edge Trigger	4,14	5,6,7,9,12	8	10,11	$t_M(10,11) = 2.48 RC$
Negative-Edge Trigger	4,8,14	5,7,9,12	6	10,11	
Retriggerable	4,14	5,6,7,9	8,12	10,11	
External Countdown*	14	5,6,7,8,9,12	—	10,11	

▲ See Text.

* First positive 1/2 cycle pulse-width = 2.48 RC, see Note on Page 3-134.

* Input Pulse to Reset of External Counting Chip External Counting Chip Output To Terminal 4

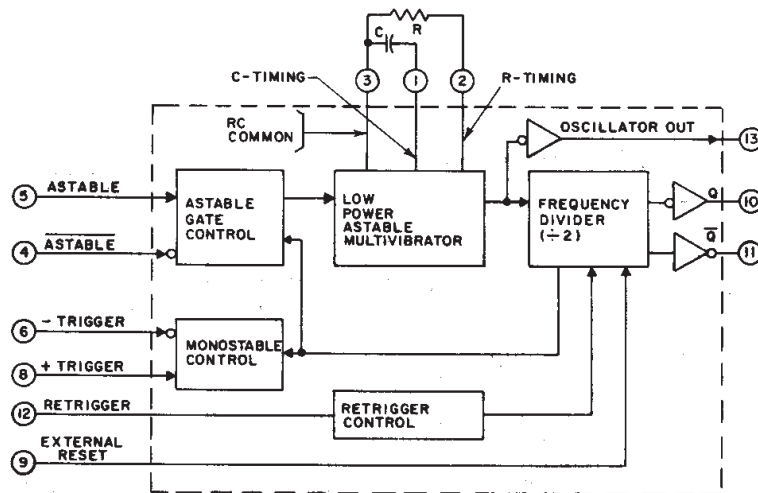

Fig. 1—CD4047B logic block diagram.

92CS-29071

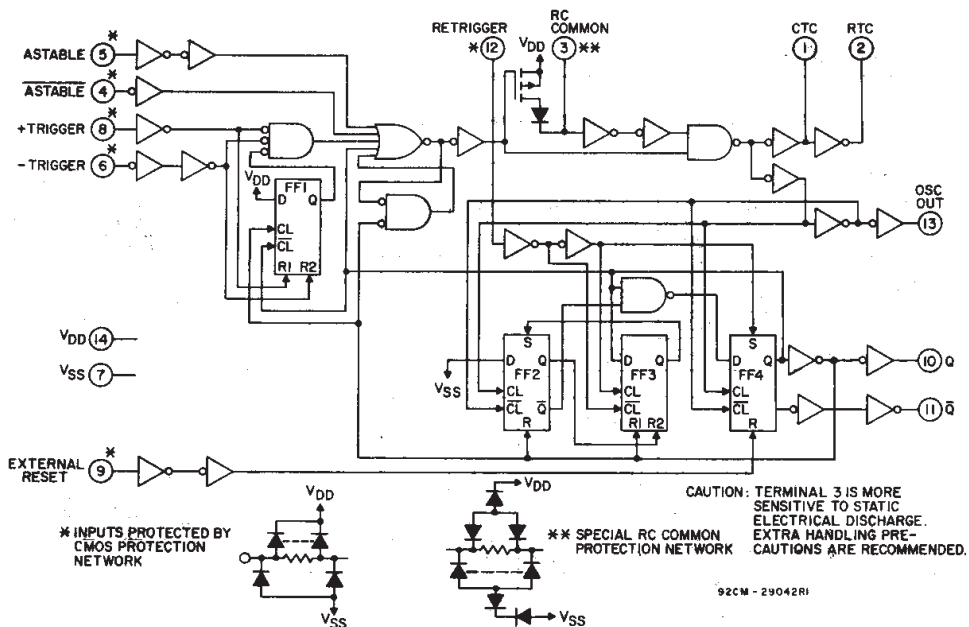

Fig. 2—CD4047B logic diagram.

92CM-29042R1

CD4047B Types

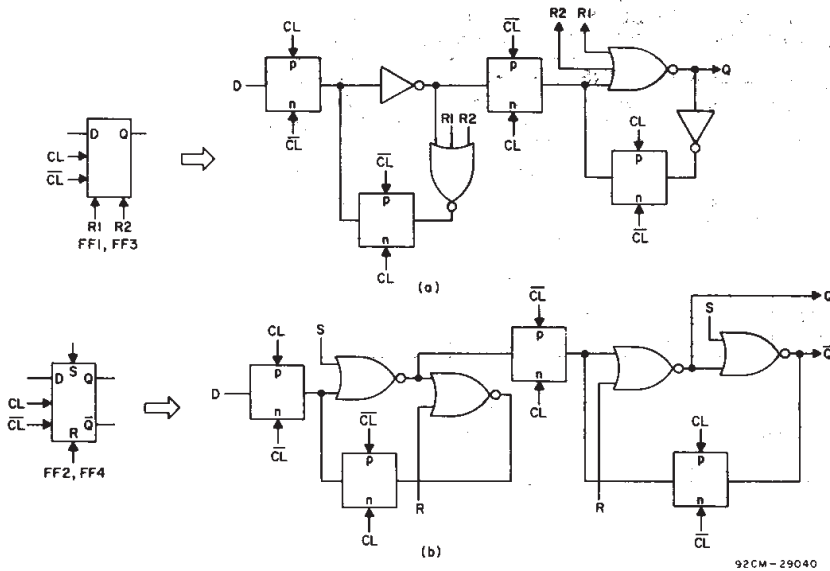

Fig. 3—Detail logic diagram for flip-flops FF1 and FF3 (a) and for flip-flops FF2 and FF4 (b).

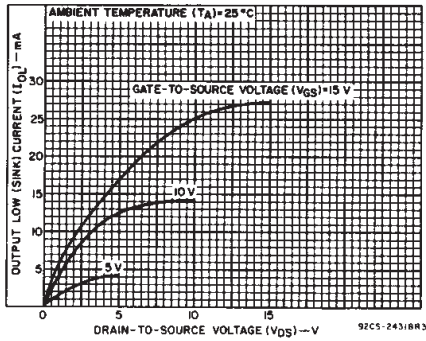

Fig. 4—Typical output low (sink) current characteristics.

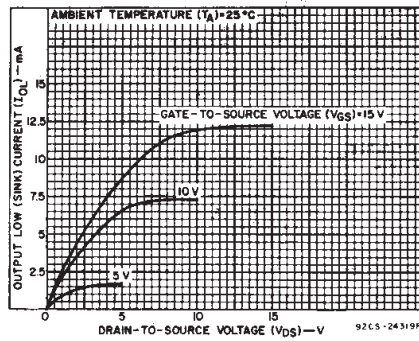

Fig. 5—Minimum output low (sink) current characteristics.

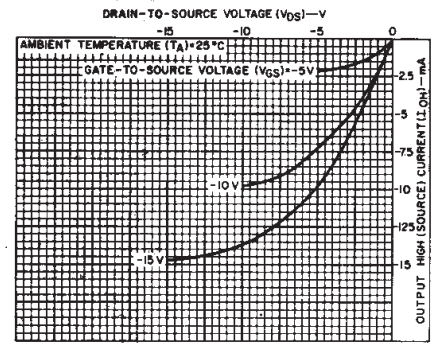

Fig. 6—Typical output high (source) current characteristics.

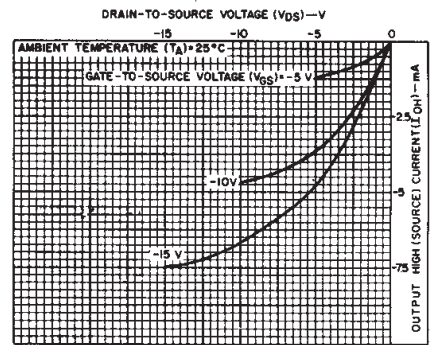

Fig. 7—Minimum output high (source) current characteristics.

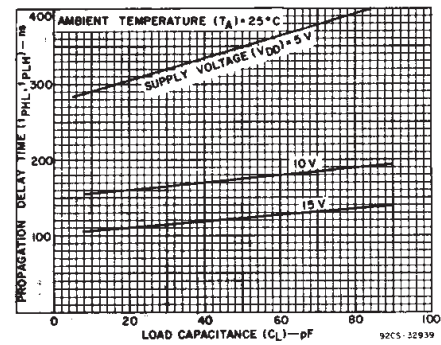

Fig. 8—Typical propagation delay time as a function of load capacitance (Astable, Astable to Q, \bar{Q}).

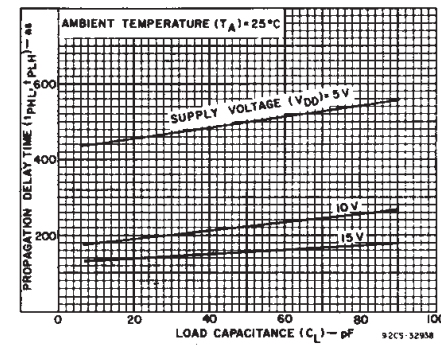

Fig. 9—Typical propagation delay time as a function of load capacitance (+ or - trigger to Q, \bar{Q}).

STATIC ELECTRICAL CHARACTERISTICS

CHARACTERISTICS	CONDITIONS			LIMITS AT INDICATED TEMPERATURES (°C)							UNITS
	V_O (V)	V_{IN} (V)	V_{DD} (V)	-55	-40	+85	+125	+25			
								Min.	Typ.	Max.	
Quiescent Device Current, I_{DD} Max.	—	0,5	5	1	1	30	30	—	0,02	1	μA
	—	0,10	10	2	2	60	60	—	0,02	2	
	—	0,15	15	4	4	120	120	—	0,02	4	
Output Low (Sink) Current I_{OL} Min.	0,4	0,5	5	0,64	0,61	0,42	0,36	0,51	1	—	mA
	0,5	0,10	10	1,6	1,5	1,1	0,9	1,3	2,6	—	
	1,5	0,15	15	4,2	4	2,8	2,4	3,4	6,8	—	
Output High (Source) Current, I_{OH} Min.	4,6	0,5	5	-0,64	-0,61	-0,42	-0,36	-0,51	-1	—	mA
	2,5	0,5	5	-2	-1,8	-1,3	-1,15	-1,6	-3,2	—	
	9,5	0,10	10	-1,6	-1,5	-1,1	-0,9	-1,3	-2,6	—	
Output Voltage: Low-Level V_{OL} Max.	—	0,5	5	0,05			—	0	0,05	—	V
	—	0,10	10	0,05			—	0	0,05	—	
	—	0,15	15	0,05			—	0	0,05	—	

CD4047B Types

STATIC ELECTRICAL CHARACTERISTICS (CONTINUED)

CHARACTERISTICS	CONDITIONS			LIMITS AT INDICATED TEMPERATURES (°C)						UNITS	
	V _O (V)	V _{IN} (V)	V _{DD} (V)	-55	-40	+85	+125	+25			
								Min.	Typ.		Max.
Output Voltage: High-Level, V _{OH} Min.	—	0.5	5	4.95				4.95	5	—	V
	—	0.10	10	9.95				9.95	10	—	
	—	0.15	15	14.95				14.95	15	—	
Input Low Voltage, V _{IL} Max.	0.5, 4.5	—	5	1.5				—	—	1.5	V
	1.9	—	10	3				—	—	3	
	1.5, 13.5	—	15	4				—	—	4	
Input High Voltage, V _{IH} Min.	0.5, 4.5	—	5	3.5				3.5	—	—	V
	1.9	—	10	7				7	—	—	
	1.5, 13.5	—	15	11				11	—	—	
Input Current I _{IN} Max.	—	0.18	18	±0.1	±0.1	±1	±1	—	±10 ⁵	±0.1	μA

DYNAMIC ELECTRICAL CHARACTERISTICS at T_A = 25°C; Input t_r, t_f = 20 ns, C_L = 50 pF, R_L = 200 kΩ

CHARACTERISTIC	V _{DD} (V)	LIMITS			UNITS
		MIN.	TYP.	MAX.	
Propagation Delay Time, t _{PHL} , t _{PLH} Astable, Astable to Osc. Out	5	—	200	400	ns
	10	—	100	200	
	15	—	80	160	
Astable, Astable to Q, Q̄	5	—	350	700	
	10	—	175	350	
	15	—	125	250	
+ or - Trigger to Q, Q̄	5	—	500	1000	
	10	—	225	450	
	15	—	150	300	
Retrigger to Q, Q̄	5	—	300	600	
	10	—	150	300	
	15	—	100	200	
External Reset to Q, Q̄	5	—	250	500	
	10	—	100	200	
	15	—	70	140	
Transition Time, t _{NL} , t _{LH} Osc. Out, Q, Q̄	5	—	100	200	
	10	—	50	100	
	15	—	40	80	
Minimum Input Pulse Width, t _w + Trigger, - Trigger	5	—	200	400	
	10	—	80	160	
	15	—	50	100	
	5	—	100	200	
	10	—	50	100	
Reset	5	—	300	600	
	10	—	115	230	
	15	—	75	150	
Input Rise and Fall Time, t _r , t _f All Trigger Inputs For + Trigger: t _r t _r only is unlimited For - Trigger: t _f t _f only is unlimited	5	—	270	—	μs
	10	—	18	—	
	15	—	9	—	
	5	—	325	—	
	10	—	9	—	
	15	—	4	—	
Q or Q̄ Deviation from 50% Duty Factor	5	—	±0.5	±1	%
	10	—	±0.5	±1	
	15	—	±0.1	±0.5	
Input Capacitance, C _{IN}	Any Input	—	5	7.7	pF

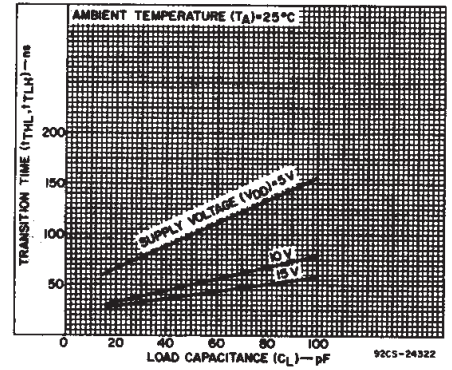

Fig. 10—Typical transition time as a function of load capacitance.

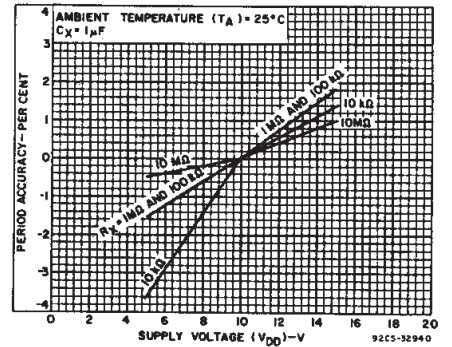

Fig. 11—Typical astable oscillator or Q, Q̄ period accuracy vs. supply voltage.

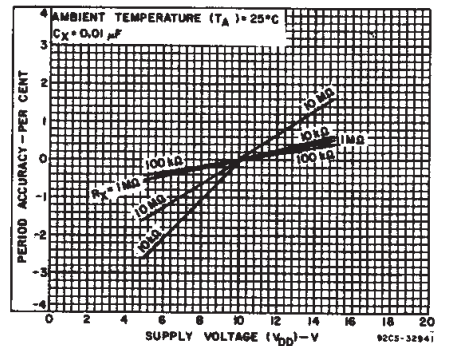

Fig. 12—Typical astable oscillator or Q, Q̄ period accuracy vs. supply voltage.

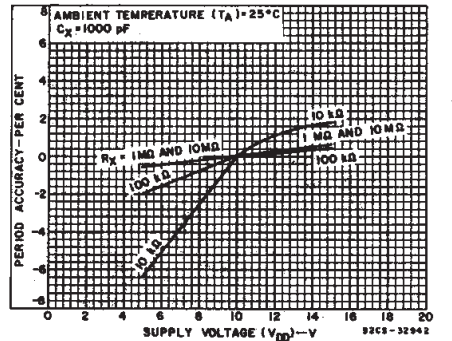

Fig. 13—Typical astable oscillator or Q, Q̄ period accuracy vs. supply voltage.

CD4047B Types

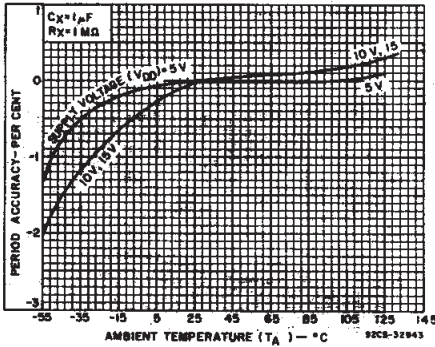

Fig. 14—Typical astable oscillator or Q, \bar{Q} period accuracy vs. ambient temperature (ultra-low frequency).

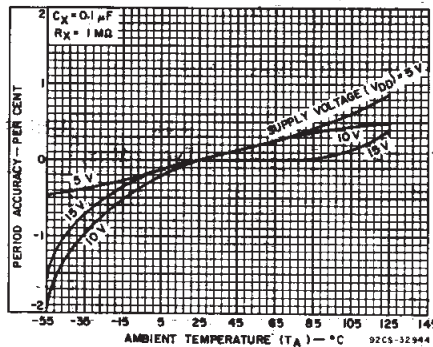

Fig. 15—Typical astable oscillator or Q, \bar{Q} period accuracy vs. ambient temperature (low frequency).

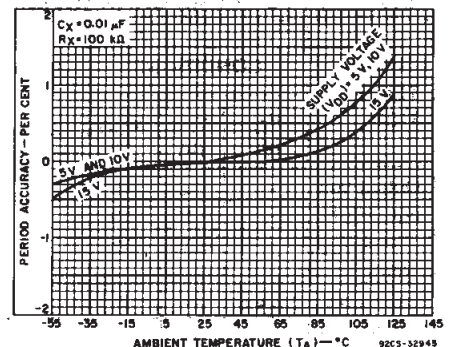

Fig. 16—Typical astable oscillator or Q, \bar{Q} period accuracy vs. ambient temperature (medium frequency).

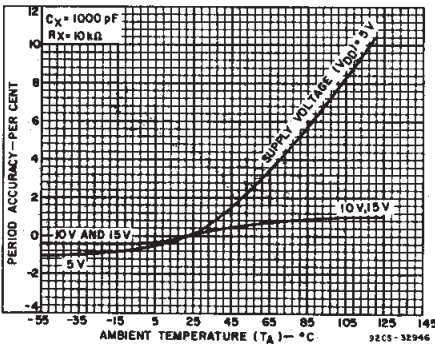

Fig. 17—Typical astable oscillator or Q, \bar{Q} period accuracy vs. ambient temperature (high-frequency).

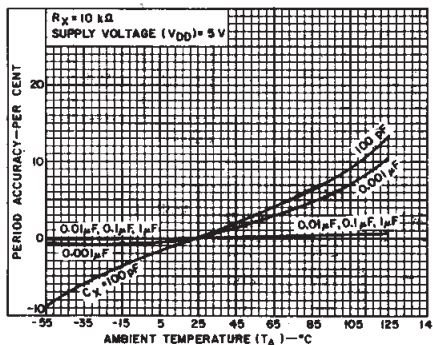

Fig. 18—Typical astable oscillator or Q, \bar{Q} period accuracy vs. ambient temperature.

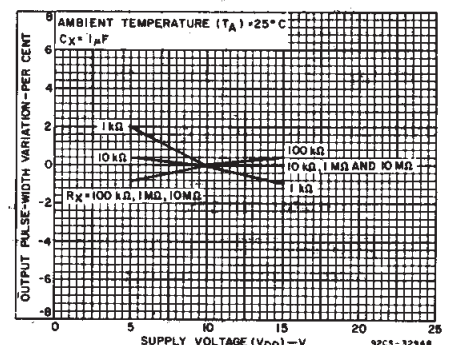

Fig. 19—Typical output pulse-width variations vs. supply voltage.

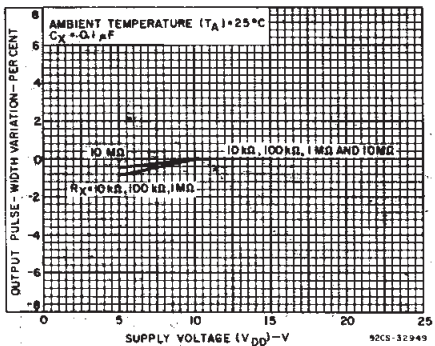

Fig. 20—Typical output pulse-width variations vs. supply voltage.

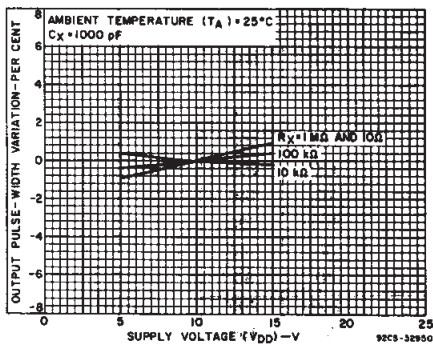

Fig. 21—Typical output pulse-width variations vs. supply voltage.

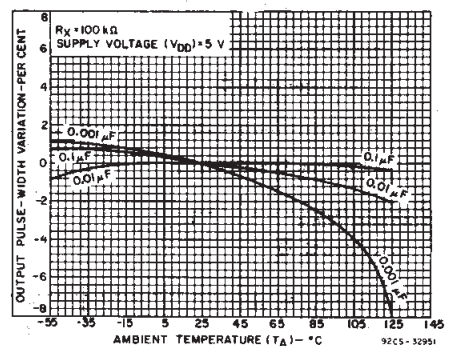

Fig. 22—Typical output pulse-width variations vs. ambient temperature.

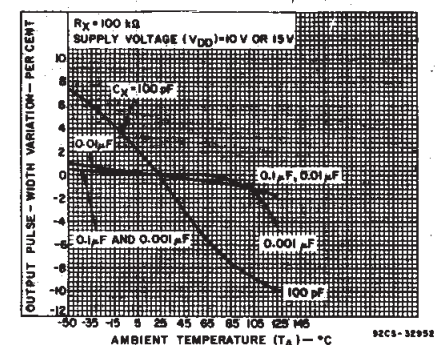

Fig. 23—Typical output pulse-width variations vs. ambient temperature.

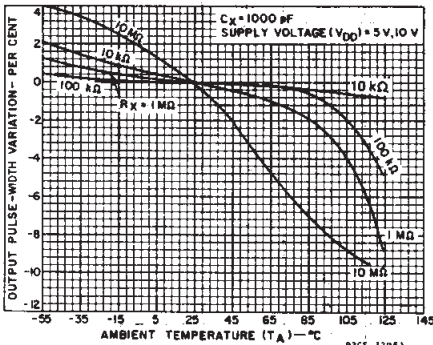

Fig. 24—Typical output pulse-width variations vs. ambient temperature.

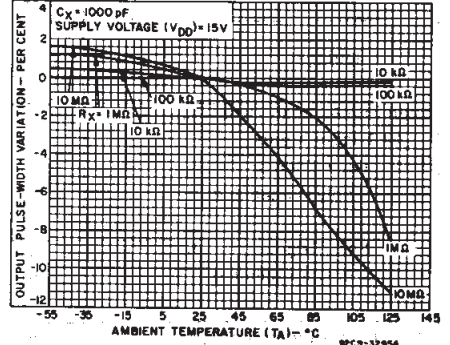

Fig. 25—Typical output pulse-width variations vs. ambient temperature.

CD4047B Types

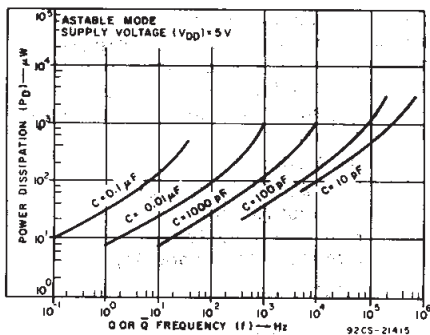

Fig. 26—Typical power dissipation vs. output frequency ($V_{DD} = 5\text{ V}$).

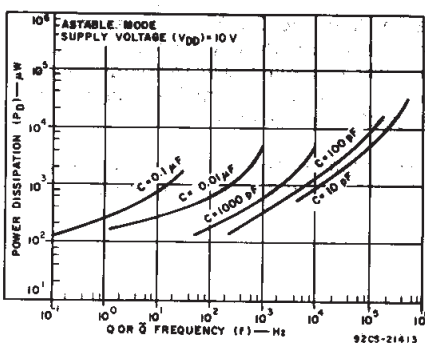

Fig. 27—Typical power dissipation vs. output frequency ($V_{DD} = 10\text{ V}$).

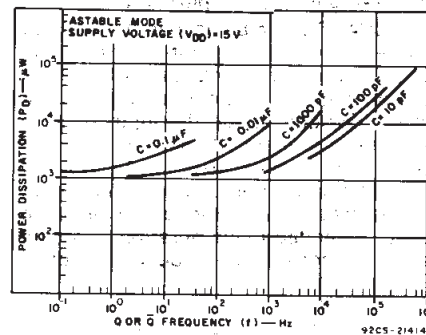

Fig. 28—Typical power dissipation vs. output frequency ($V_{DD} = 15\text{ V}$).

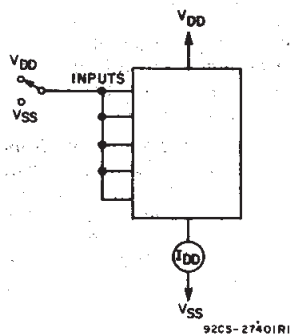

Fig. 29—Quiescent device current test circuit.

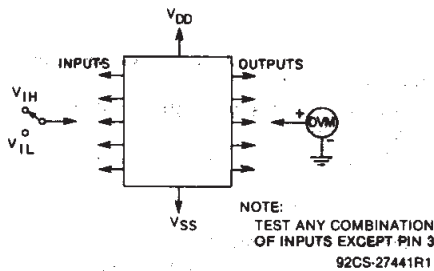

Fig. 30—Input-voltage test circuit.

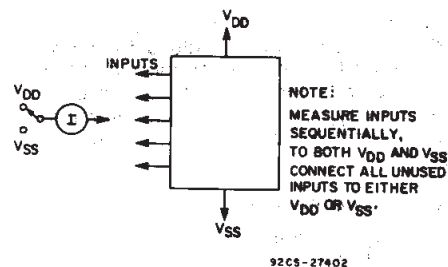

Fig. 31—Input-leakage-current test circuit.

1. Astable Mode Design Information

A. Unit-to-Unit Transfer-Voltage Variations — The following analysis presents variations from unit to unit as a function of transfer-voltage (V_{TR}) shift (33%–67% V_{DD}) for free-running (astable) operation.

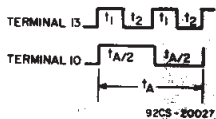

Fig. 32—Astable mode waveforms.

$$t_1 = -RC \ln \frac{V_{TR}}{V_{DD} + V_{TR}};$$

typically, $t_1 = 1.1 RC$

$$t_2 = -RC \ln \frac{V_{DD} - V_{TR}}{2V_{DD} - V_{TR}};$$

typically, $t_2 = 1.1 RC$

$$t_A = 2(t_1 + t_2)$$

$$= -2 RC \ln \frac{(V_{TR})(V_{DD} - V_{TR})}{(V_{DD} + V_{TR})(2V_{DD} - V_{TR})}$$

Typ: $V_{TR} = 0.5 V_{DD}$ $t_A = 4.40 RC$
 Min: $V_{TR} = 0.33 V_{DD}$ $t_A = 4.62 RC$
 Max: $V_{TR} = 0.67 V_{DD}$ $t_A = 4.62 RC$

thus if $t_A = 4.40 RC$ is used, the variation will be +5%, -0% due to variations in transfer voltage.

B. Variations Due to V_{DD} and Temperature Changes — In addition to variations from unit to unit, the astable period varies with V_{DD} and temperature. Typical variations are presented in graphical form in Figs. 11 to 16 with 10V as reference for voltage variations curves and 25°C as reference for temperature variations curves.

II. Monostable Mode Design Information

The following analysis presents variations from unit to unit as a function of transfer-voltage (V_{TR}) shift (33% – 67% V_{DD}) for one-shot (monostable) operation.

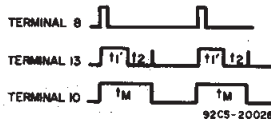

Fig. 33—Monostable waveforms.

$$t_1' = -RC \ln \frac{V_{TR}}{2V_{DD}}$$

typically, $t_1' = 1.38 RC$

$$t_M = (t_1' + t_2)$$

$$t_M = -RC \ln \frac{(V_{TR})(V_{DD} - V_{TR})}{(2V_{DD} - V_{TR})(2V_{DD})}$$

where t_M = Monostable mode pulse width. Values for t_M are as follows:

Typ: $V_{TR} = 0.5 V_{DD}$ $t_M = 2.48 RC$
 Min: $V_{TR} = 0.33 V_{DD}$ $t_M = 2.71 RC$
 Max: $V_{TR} = 0.67 V_{DD}$ $t_M = 2.48 RC$

thus if $t_M = 2.48 RC$ is used, the variation will be +9.3%, -0% due to variations in transfer voltage.

Note:

In the astable mode, the first positive half cycle has a duration of t_M ; succeeding durations are $t_A/2$.

In addition to variations from unit to unit, the monostable pulse width varies with V_{DD} and temperature. These variations are presented in graphical form in Fig. 19 to 26 with 10 V as reference for voltage-variation curves and 25°C as reference for temperature-variation curves.

CD4047B Types

III. Retrigger Mode Operation

The CD4047B can be used in the retrigger mode to extend the output-pulse duration, or to compare the frequency of an input signal with that of the internal oscillator. In the retrigger mode the input pulse is applied to terminal 12, and the output is taken from terminal 10 or 11. As shown in Fig. 34 normal monostable action is obtained when one retrigger pulse is applied. Extended pulse duration is obtained when more than one pulse is applied.

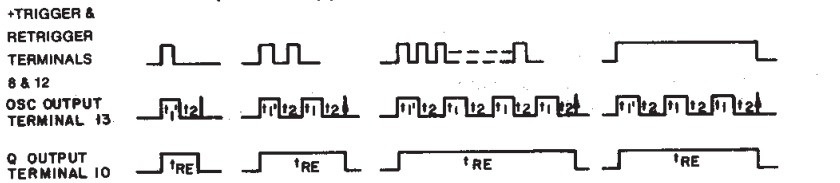

Fig. 34—Retrigger-mode waveforms.

For two input pulses, $t_{RE} = t_1' + t_1 + 2t_2$. For more than two pulses, the output pulse width is an integral number of time periods, with the first time period being $t_1' + t_2$, typically, $2.48RC$, and all subsequent time periods being $t_1 + t_2$, typically, $2.2RC$.

IV. External Counter Option

Time t_M can be extended by any amount with the use of external counting cir-

cuitry. Advantages include digitally controlled pulse duration, small timing capacitors for long time periods, and extremely fast recovery time. A typical implementation is shown in Fig. 35. The pulse duration at the output is

$$t_{ext} = (N - 1)(t_A) + (t_M + t_A/2)$$

where t_{ext} = pulse duration of the circuitry, and N is the number of counts used.

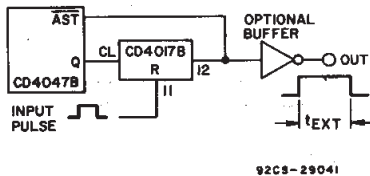

Fig. 35—Implementation of external counter option.

V. Timing-Component Limitations

The capacitor used in the circuit should be non-polarized and have low leakage (i.e. the parallel resistance of the capacitor should be at least an order of magnitude greater than the external resistor used). There is no upper or lower limit for either R or C value to maintain oscillation.

However, in consideration of accuracy, C must be much larger than the inherent stray capacitance in the system (unless this capacitance can be measured and taken into account). R must be much

larger than the CMOS "ON" resistance in series with it, which typically is hundreds of ohms. In addition, with very large values of R , some short-term instability with respect to time may be noted.

The recommended values for these components to maintain agreement with

tion of leakage current in the circuit, as shown in the static electrical characteristics. For dynamic operation, the power needed to charge the external timing capacitor C is given by the following formulae:

Astable Mode:

$$P = 2CV^2f. \text{ (Output at terminal No. 13)}$$

$$P = 4CV^2f. \text{ (Output at terminal Nos. 10 and 11)}$$

Monostable Mode:

$$P = \frac{(2.9CV^2) (\text{Duty Cycle})}{T}$$

(Output at terminal Nos. 10 and 11)

The circuit is designed so that most of the total power is consumed in the external components. In practice, the lower the values of frequency and voltage used, the closer the actual power dissipation will be to the calculated value.

Because the power dissipation does not depend on R , a design for minimum power dissipation would be a small value of C . The value of R would depend on the desired period (within the limitations discussed above). See Figs. 27, 28, and 29 for typical power consumption in astable mode.

previously calculated formulas without trimming should be:

$C \geq 100$ pF, up to any practical value, for astable modes;

$C \geq 1000$ pF, up to any practical value for monostable modes.

$10 \text{ k}\Omega \leq R \leq 1 \text{ M}\Omega$

VI. Power Consumption

In the standby mode (Monostable or Astable), power dissipation will be a func-

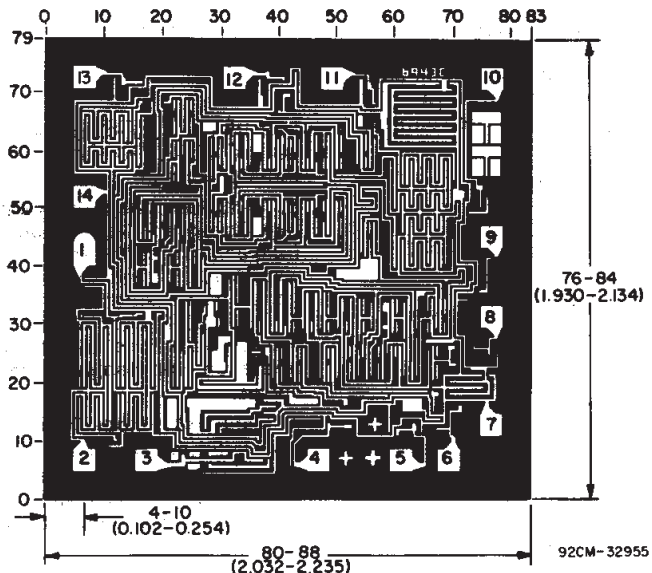

Chip dimensions and pad layout for CD4047B

Dimensions in parentheses are in millimeters and are derived from the basic inch dimensions as indicated. Grid graduations are in mils (10^{-3} inch).

PACKAGING INFORMATION

Orderable Device	Status ⁽¹⁾	Package Type	Package Drawing	Pins	Package Qty	Eco Plan ⁽²⁾	Lead/Ball Finish	MSL Peak Temp ⁽³⁾
8102001CA	ACTIVE	CDIP	J	14	1	TBD	A42	N / A for Pkg Type
CD4047BD3	ACTIVE	CDIP SB	JD	14	1	TBD	POST-PLATE	N / A for Pkg Type
CD4047BE	ACTIVE	PDIP	N	14	25	Pb-Free (RoHS)	CU NIPDAU	N / A for Pkg Type
CD4047BEE4	ACTIVE	PDIP	N	14	25	Pb-Free (RoHS)	CU NIPDAU	N / A for Pkg Type
CD4047BF	ACTIVE	CDIP	J	14	1	TBD	A42	N / A for Pkg Type
CD4047BF3A	ACTIVE	CDIP	J	14	1	TBD	A42	N / A for Pkg Type
CD4047BM	ACTIVE	SOIC	D	14	50	Green (RoHS & no Sb/Br)	CU NIPDAU	Level-1-260C-UNLIM
CD4047BM96	ACTIVE	SOIC	D	14	2500	Green (RoHS & no Sb/Br)	CU NIPDAU	Level-1-260C-UNLIM
CD4047BM96E4	ACTIVE	SOIC	D	14	2500	Green (RoHS & no Sb/Br)	CU NIPDAU	Level-1-260C-UNLIM
CD4047BM96G4	ACTIVE	SOIC	D	14	2500	Green (RoHS & no Sb/Br)	CU NIPDAU	Level-1-260C-UNLIM
CD4047BME4	ACTIVE	SOIC	D	14	50	Green (RoHS & no Sb/Br)	CU NIPDAU	Level-1-260C-UNLIM
CD4047BMG4	ACTIVE	SOIC	D	14	50	Green (RoHS & no Sb/Br)	CU NIPDAU	Level-1-260C-UNLIM
CD4047BMT	ACTIVE	SOIC	D	14	250	Green (RoHS & no Sb/Br)	CU NIPDAU	Level-1-260C-UNLIM
CD4047BMTE4	ACTIVE	SOIC	D	14	250	Green (RoHS & no Sb/Br)	CU NIPDAU	Level-1-260C-UNLIM
CD4047BMTG4	ACTIVE	SOIC	D	14	250	Green (RoHS & no Sb/Br)	CU NIPDAU	Level-1-260C-UNLIM
CD4047BNSR	ACTIVE	SO	NS	14	2000	Green (RoHS & no Sb/Br)	CU NIPDAU	Level-1-260C-UNLIM
CD4047BNSRE4	ACTIVE	SO	NS	14	2000	Green (RoHS & no Sb/Br)	CU NIPDAU	Level-1-260C-UNLIM
CD4047BNSRG4	ACTIVE	SO	NS	14	2000	Green (RoHS & no Sb/Br)	CU NIPDAU	Level-1-260C-UNLIM
CD4047BPW	ACTIVE	TSSOP	PW	14	90	Green (RoHS & no Sb/Br)	CU NIPDAU	Level-1-260C-UNLIM
CD4047BPWE4	ACTIVE	TSSOP	PW	14	90	Green (RoHS & no Sb/Br)	CU NIPDAU	Level-1-260C-UNLIM
CD4047BPWG4	ACTIVE	TSSOP	PW	14	90	Green (RoHS & no Sb/Br)	CU NIPDAU	Level-1-260C-UNLIM
CD4047BPWR	ACTIVE	TSSOP	PW	14	2000	Green (RoHS & no Sb/Br)	CU NIPDAU	Level-1-260C-UNLIM
CD4047BPWRE4	ACTIVE	TSSOP	PW	14	2000	Green (RoHS & no Sb/Br)	CU NIPDAU	Level-1-260C-UNLIM
CD4047BPWRG4	ACTIVE	TSSOP	PW	14	2000	Green (RoHS & no Sb/Br)	CU NIPDAU	Level-1-260C-UNLIM

⁽¹⁾ The marketing status values are defined as follows:

ACTIVE: Product device recommended for new designs.

LIFEBUY: TI has announced that the device will be discontinued, and a lifetime-buy period is in effect.

NRND: Not recommended for new designs. Device is in production to support existing customers, but TI does not recommend using this part in a new design.

PREVIEW: Device has been announced but is not in production. Samples may or may not be available.

OBSOLETE: TI has discontinued the production of the device.

⁽²⁾ Eco Plan - The planned eco-friendly classification: Pb-Free (RoHS), Pb-Free (RoHS Exempt), or Green (RoHS & no Sb/Br) - please check <http://www.ti.com/productcontent> for the latest availability information and additional product content details.

TBD: The Pb-Free/Green conversion plan has not been defined.

Pb-Free (RoHS): TI's terms "Lead-Free" or "Pb-Free" mean semiconductor products that are compatible with the current RoHS requirements for all 6 substances, including the requirement that lead not exceed 0.1% by weight in homogeneous materials. Where designed to be soldered at high temperatures, TI Pb-Free products are suitable for use in specified lead-free processes.

Pb-Free (RoHS Exempt): This component has a RoHS exemption for either 1) lead-based flip-chip solder bumps used between the die and package, or 2) lead-based die adhesive used between the die and leadframe. The component is otherwise considered Pb-Free (RoHS compatible) as defined above.

Green (RoHS & no Sb/Br): TI defines "Green" to mean Pb-Free (RoHS compatible), and free of Bromine (Br) and Antimony (Sb) based flame retardants (Br or Sb do not exceed 0.1% by weight in homogeneous material)

⁽³⁾ MSL, Peak Temp. -- The Moisture Sensitivity Level rating according to the JEDEC industry standard classifications, and peak solder temperature.

Important Information and Disclaimer:The information provided on this page represents TI's knowledge and belief as of the date that it is provided. TI bases its knowledge and belief on information provided by third parties, and makes no representation or warranty as to the accuracy of such information. Efforts are underway to better integrate information from third parties. TI has taken and continues to take reasonable steps to provide representative and accurate information but may not have conducted destructive testing or chemical analysis on incoming materials and chemicals. TI and TI suppliers consider certain information to be proprietary, and thus CAS numbers and other limited information may not be available for release.

In no event shall TI's liability arising out of such information exceed the total purchase price of the TI part(s) at issue in this document sold by TI to Customer on an annual basis.

TAPE AND REEL INFORMATION



QUADRANT ASSIGNMENTS FOR PIN 1 ORIENTATION IN TAPE



*All dimensions are nominal

Device	Package Type	Package Drawing	Pins	SPQ	Reel Diameter (mm)	Reel Width W1 (mm)	A0 (mm)	B0 (mm)	K0 (mm)	P1 (mm)	W (mm)	Pin1 Quadrant
CD4047BM96	SOIC	D	14	2500	330.0	16.4	6.5	9.0	2.1	8.0	16.0	Q1
CD4047BMT	SOIC	D	14	250	330.0	16.4	6.5	9.0	2.1	8.0	16.0	Q1
CD4047BNSR	SO	NS	14	2000	330.0	16.4	8.2	10.5	2.5	12.0	16.0	Q1
CD4047BPWR	TSSOP	PW	14	2000	330.0	12.4	6.9	5.6	1.6	8.0	12.0	Q1

TAPE AND REEL BOX DIMENSIONS

*All dimensions are nominal

Device	Package Type	Package Drawing	Pins	SPQ	Length (mm)	Width (mm)	Height (mm)
CD4047BM96	SOIC	D	14	2500	346.0	346.0	33.0
CD4047BMT	SOIC	D	14	250	346.0	346.0	33.0
CD4047BNSR	SO	NS	14	2000	346.0	346.0	33.0
CD4047BPWR	TSSOP	PW	14	2000	346.0	346.0	29.0

JD (R-CDIP-T14)

CERAMIC SIDE-BRAZE DUAL-IN-LINE

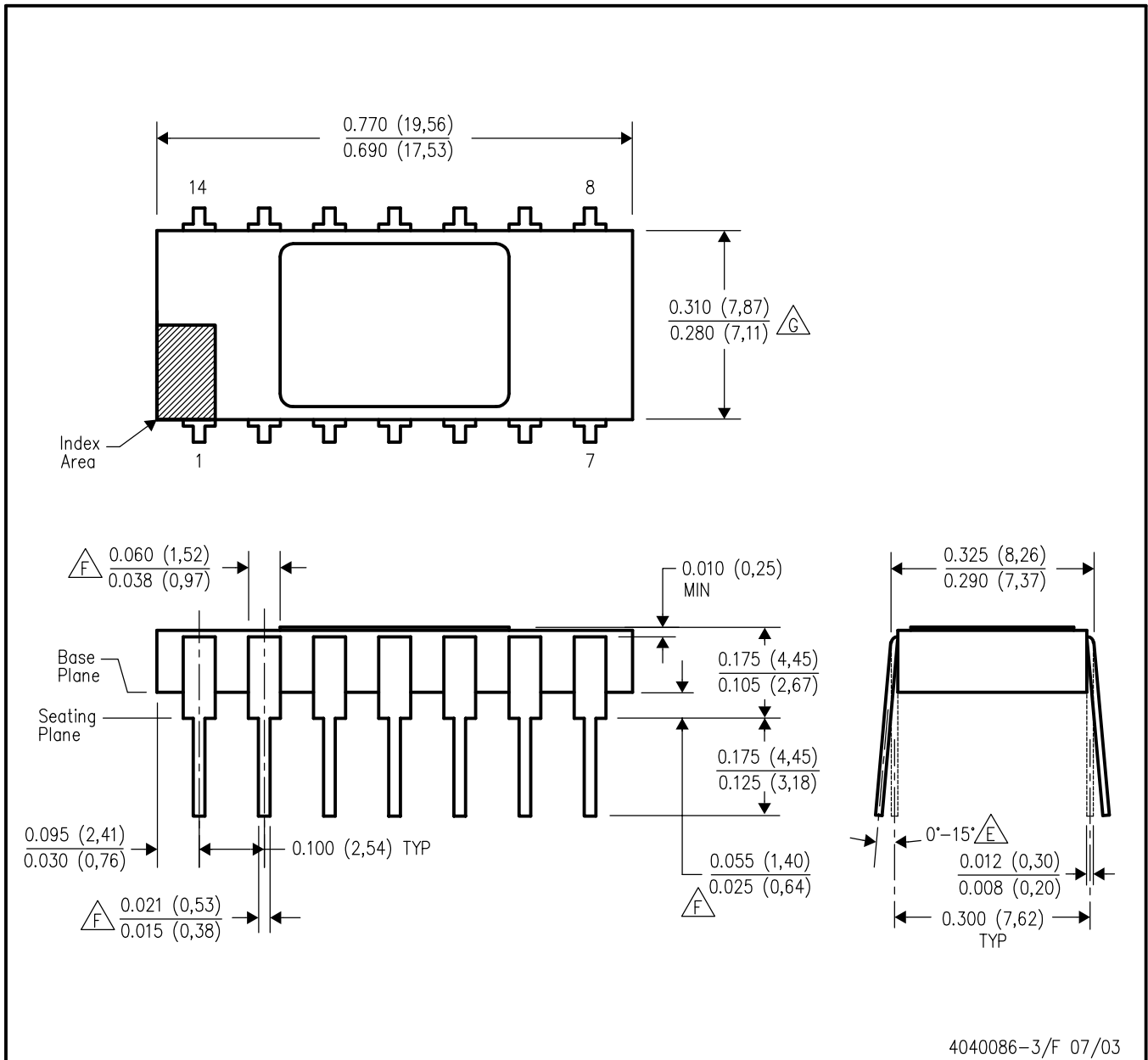

J (R-GDIP-T**)

14 LEADS SHOWN

CERAMIC DUAL IN-LINE PACKAGE



DIM \ PINS **	14	16	18	20
A	0.300 (7,62) BSC	0.300 (7,62) BSC	0.300 (7,62) BSC	0.300 (7,62) BSC
B MAX	0.785 (19,94)	.840 (21,34)	0.960 (24,38)	1.060 (26,92)
B MIN	—	—	—	—
C MAX	0.300 (7,62)	0.300 (7,62)	0.310 (7,87)	0.300 (7,62)
C MIN	0.245 (6,22)	0.245 (6,22)	0.220 (5,59)	0.245 (6,22)



4040083/F 03/03

- NOTES:
- All linear dimensions are in inches (millimeters).
 - This drawing is subject to change without notice.
 - This package is hermetically sealed with a ceramic lid using glass frit.
 - Index point is provided on cap for terminal identification only on press ceramic glass frit seal only.
 - Falls within MIL STD 1835 GDIP1-T14, GDIP1-T16, GDIP1-T18 and GDIP1-T20.

N (R-PDIP-T**)

PLASTIC DUAL-IN-LINE PACKAGE

16 PINS SHOWN



4040049/E 12/2002

- NOTES:
- A. All linear dimensions are in inches (millimeters).
 - B. This drawing is subject to change without notice.
 - (C) Falls within JEDEC MS-001, except 18 and 20 pin minimum body length (Dim A).
 - (D) The 20 pin end lead shoulder width is a vendor option, either half or full width.

D (R-PDSO-G14)

PLASTIC SMALL OUTLINE

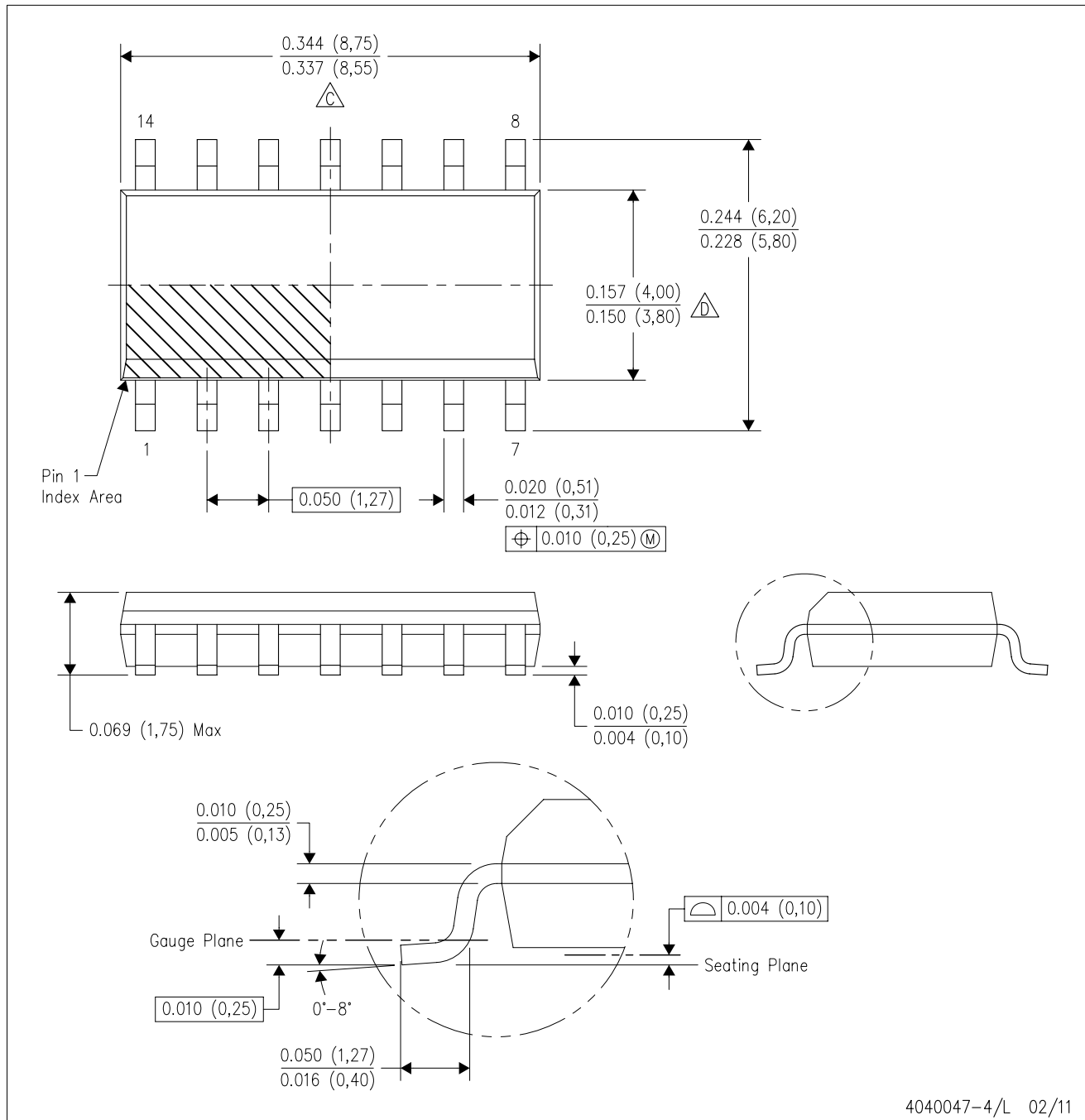

- NOTES:
- A. All linear dimensions are in inches (millimeters).
 - B. This drawing is subject to change without notice.
 - Body length does not include mold flash, protrusions, or gate burrs. Mold flash, protrusions, or gate burrs shall not exceed 0.006 (0,15) each side.
 - Body width does not include interlead flash. Interlead flash shall not exceed 0.017 (0,43) each side.
 - E. Reference JEDEC MS-012 variation AB.

D (R-PDSO-G14)

PLASTIC SMALL OUTLINE

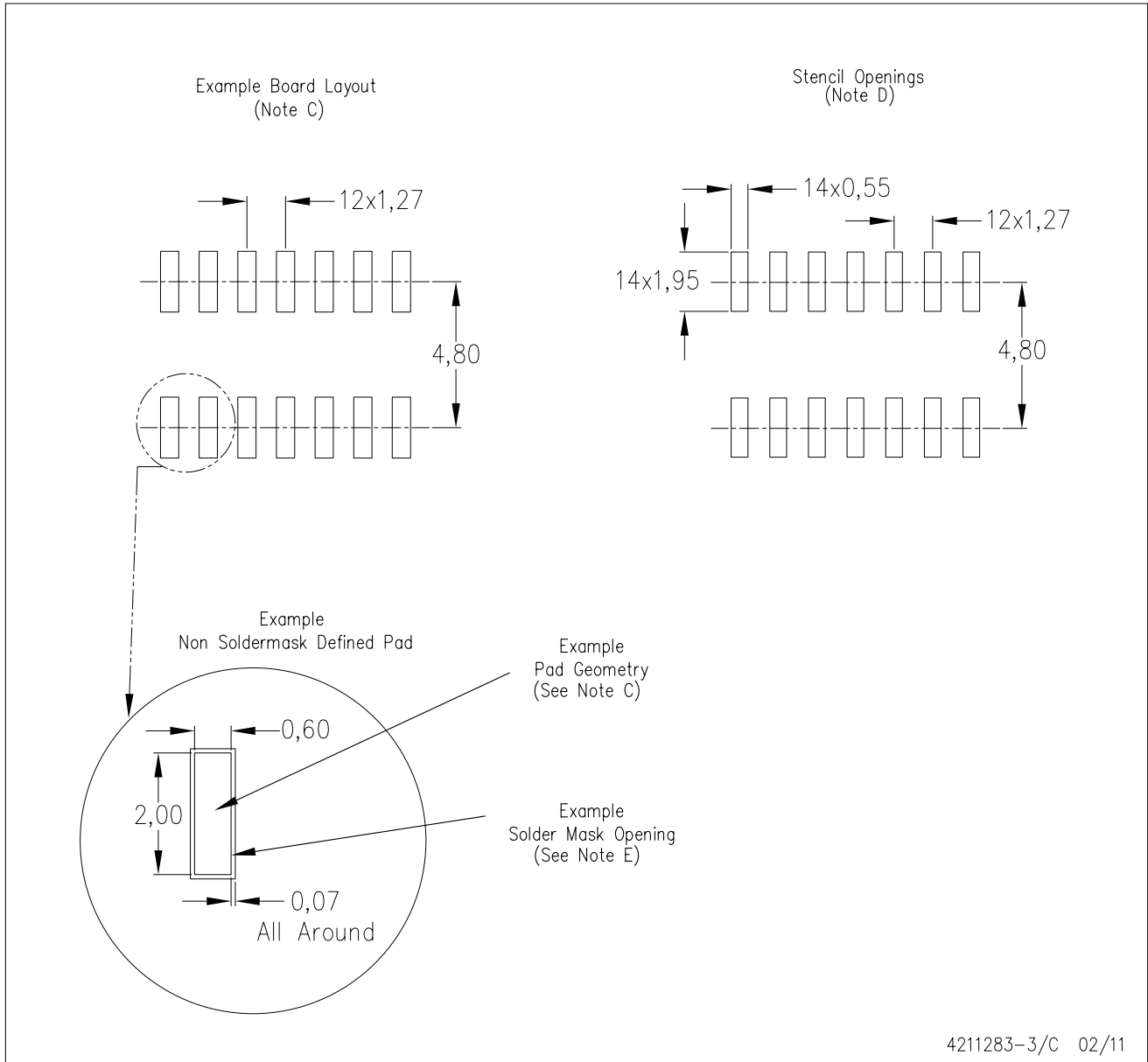

4211283-3/C 02/11

- NOTES:
- A. All linear dimensions are in millimeters.
 - B. This drawing is subject to change without notice.
 - C. Publication IPC-7351 is recommended for alternate designs.
 - D. Laser cutting apertures with trapezoidal walls and also rounding corners will offer better paste release. Customers should contact their board assembly site for stencil design recommendations. Refer to IPC-7525 for other stencil recommendations.
 - E. Customers should contact their board fabrication site for solder mask tolerances between and around signal pads.

PW (R-PDSO-G14)

PLASTIC SMALL OUTLINE



4040064-3/G 02/11

- NOTES:
- A. All linear dimensions are in millimeters. Dimensioning and tolerancing per ASME Y14.5M-1994.
 - B. This drawing is subject to change without notice.
 - C. Body length does not include mold flash, protrusions, or gate burrs. Mold flash, protrusions, or gate burrs shall not exceed 0,15 each side.
 - D. Body width does not include interlead flash. Interlead flash shall not exceed 0,25 each side.
 - E. Falls within JEDEC MO-153

PW (R-PDSO-G14)

PLASTIC SMALL OUTLINE

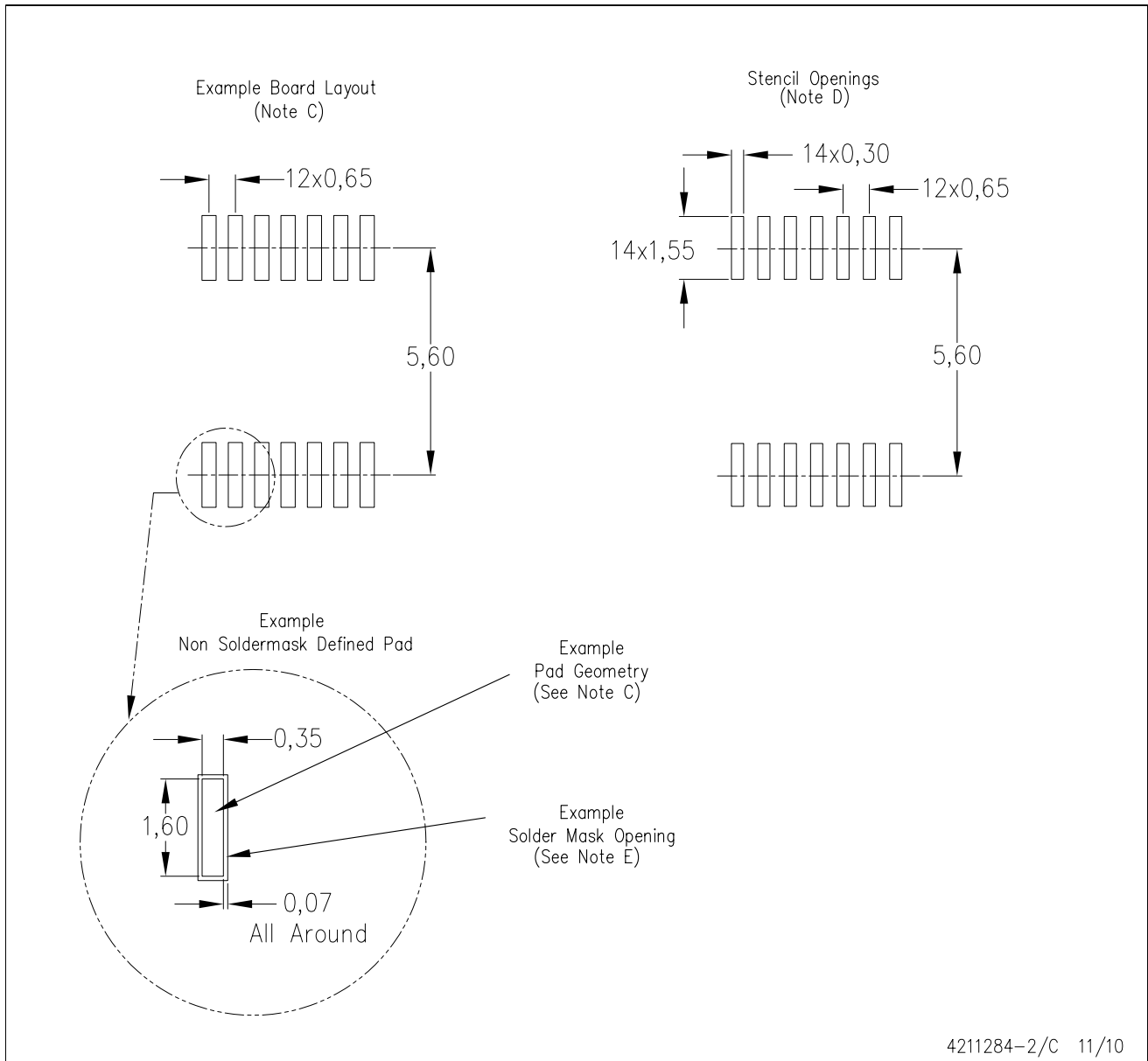

- NOTES:
- All linear dimensions are in millimeters.
 - This drawing is subject to change without notice.
 - Publication IPC-7351 is recommended for alternate designs.
 - Laser cutting apertures with trapezoidal walls and also rounding corners will offer better paste release. Customers should contact their board assembly site for stencil design recommendations. Refer to IPC-7525 for other stencil recommendations.
 - Customers should contact their board fabrication site for solder mask tolerances between and around signal pads.

MECHANICAL DATA

NS (R-PDSO-G)**

PLASTIC SMALL-OUTLINE PACKAGE

14-PINS SHOWN



- NOTES:
- A. All linear dimensions are in millimeters.
 - B. This drawing is subject to change without notice.
 - C. Body dimensions do not include mold flash or protrusion, not to exceed 0,15.

IMPORTANT NOTICE

Texas Instruments Incorporated and its subsidiaries (TI) reserve the right to make corrections, modifications, enhancements, improvements, and other changes to its products and services at any time and to discontinue any product or service without notice. Customers should obtain the latest relevant information before placing orders and should verify that such information is current and complete. All products are sold subject to TI's terms and conditions of sale supplied at the time of order acknowledgment.

TI warrants performance of its hardware products to the specifications applicable at the time of sale in accordance with TI's standard warranty. Testing and other quality control techniques are used to the extent TI deems necessary to support this warranty. Except where mandated by government requirements, testing of all parameters of each product is not necessarily performed.

TI assumes no liability for applications assistance or customer product design. Customers are responsible for their products and applications using TI components. To minimize the risks associated with customer products and applications, customers should provide adequate design and operating safeguards.

TI does not warrant or represent that any license, either express or implied, is granted under any TI patent right, copyright, mask work right, or other TI intellectual property right relating to any combination, machine, or process in which TI products or services are used. Information published by TI regarding third-party products or services does not constitute a license from TI to use such products or services or a warranty or endorsement thereof. Use of such information may require a license from a third party under the patents or other intellectual property of the third party, or a license from TI under the patents or other intellectual property of TI.

Reproduction of TI information in TI data books or data sheets is permissible only if reproduction is without alteration and is accompanied by all associated warranties, conditions, limitations, and notices. Reproduction of this information with alteration is an unfair and deceptive business practice. TI is not responsible or liable for such altered documentation. Information of third parties may be subject to additional restrictions.

Resale of TI products or services with statements different from or beyond the parameters stated by TI for that product or service voids all express and any implied warranties for the associated TI product or service and is an unfair and deceptive business practice. TI is not responsible or liable for any such statements.

TI products are not authorized for use in safety-critical applications (such as life support) where a failure of the TI product would reasonably be expected to cause severe personal injury or death, unless officers of the parties have executed an agreement specifically governing such use. Buyers represent that they have all necessary expertise in the safety and regulatory ramifications of their applications, and acknowledge and agree that they are solely responsible for all legal, regulatory and safety-related requirements concerning their products and any use of TI products in such safety-critical applications, notwithstanding any applications-related information or support that may be provided by TI. Further, Buyers must fully indemnify TI and its representatives against any damages arising out of the use of TI products in such safety-critical applications.

TI products are neither designed nor intended for use in military/aerospace applications or environments unless the TI products are specifically designated by TI as military-grade or "enhanced plastic." Only products designated by TI as military-grade meet military specifications. Buyers acknowledge and agree that any such use of TI products which TI has not designated as military-grade is solely at the Buyer's risk, and that they are solely responsible for compliance with all legal and regulatory requirements in connection with such use.

TI products are neither designed nor intended for use in automotive applications or environments unless the specific TI products are designated by TI as compliant with ISO/TS 16949 requirements. Buyers acknowledge and agree that, if they use any non-designated products in automotive applications, TI will not be responsible for any failure to meet such requirements.

Following are URLs where you can obtain information on other Texas Instruments products and application solutions:

Products

Audio	www.ti.com/audio
Amplifiers	amplifier.ti.com
Data Converters	dataconverter.ti.com
DLP® Products	www.dlp.com
DSP	dsp.ti.com
Clocks and Timers	www.ti.com/clocks
Interface	interface.ti.com
Logic	logic.ti.com
Power Mgmt	power.ti.com
Microcontrollers	microcontroller.ti.com
RFID	www.ti-rfid.com
RF/IF and ZigBee® Solutions	www.ti.com/lprf

Applications

Communications and Telecom	www.ti.com/communications
Computers and Peripherals	www.ti.com/computers
Consumer Electronics	www.ti.com/consumer-apps
Energy and Lighting	www.ti.com/energy
Industrial	www.ti.com/industrial
Medical	www.ti.com/medical
Security	www.ti.com/security
Space, Avionics and Defense	www.ti.com/space-avionics-defense
Transportation and Automotive	www.ti.com/automotive
Video and Imaging	www.ti.com/video
Wireless	www.ti.com/wireless-apps

TI E2E Community Home Page

e2e.ti.com

Mailing Address: Texas Instruments, Post Office Box 655303, Dallas, Texas 75265
Copyright © 2011, Texas Instruments Incorporated