

MOSFET - Power, Single N-Channel, Logic Level, SO-8FL

40 V, 0.49 mΩ, 455 A

NTMFS0D5N04XL

Features

- Low $R_{DS(on)}$ to Minimize Conduction Loss
- Low Q_{RR} with Soft Recovery to Minimize E_{RR} Loss and Voltage Spike
- Low Q_G and Capacitance to Minimize Driving and Switching Loss
- These Devices are Pb-Free, Halogen Free/BFR Free and are RoHS Compliant

Typical Applications

- High Switching Frequency DC-DC Conversion
- Synchronous Rectification

MAXIMUM RATINGS ($T_C = 25^\circ\text{C}$ unless otherwise stated)

Parameter		Symbol	Value	Unit	
Drain-to-Source Voltage		V_{DSS}	40	V	
Gate-to-Source Voltage		V_{GS}	± 20	V	
Continuous Drain Current $R_{\theta JC}$ (Note 2)	Steady State	I_D	$T_C = 25^\circ\text{C}$	455	A
			$T_C = 100^\circ\text{C}$	322	
Power Dissipation $R_{\theta JC}$ (Note 2)	Steady State	P_D	$T_C = 25^\circ\text{C}$	194	W
			$T_C = 100^\circ\text{C}$	97.3	
Pulsed Drain Current	$T_A = 25^\circ\text{C}, t_p = 100 \mu\text{s}$	I_{DM}	2474	A	
Pulsed Sourced Current (Body Diode)		I_{SM}	2474		
Operating Junction and Storage Temperature Range		T_J, T_{STG}	-55 to +175	$^\circ\text{C}$	
Source Current (Body Diode)		I_S	306	A	
Single Pulse Drain-to-Source Avalanche Energy ($I_{Lpk} = 94 \text{ A}$)		E_{AS}	1325	mJ	
Lead Temperature Soldering Reflow for Soldering Purposes (1/8" from case for 10 s)		T_L	260	$^\circ\text{C}$	

Stresses exceeding those listed in the Maximum Ratings table may damage the device. If any of these limits are exceeded, device functionality should not be assumed, damage may occur and reliability may be affected.

1. Surface-mounted on FR4 board using 1 in² pad size, 1 oz Cu pad.
2. The entire application environment impacts the thermal resistance values shown, they are not constants and are only valid for the particular conditions noted.
3. $R_{\theta JCT}$ Thermal Resistance - Junction to Case Top = 20 $^\circ\text{C}/\text{W}$.

$V_{(BR)DSS}$	$R_{DS(ON)} \text{ MAX}$	$I_D \text{ MAX}$
40 V	0.49 mΩ @ 10 V	455 A
	0.78 mΩ @ 4.5 V	

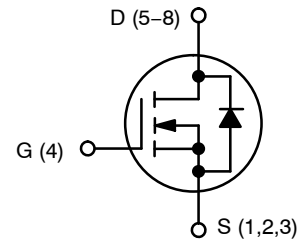

N-CHANNEL MOSFET

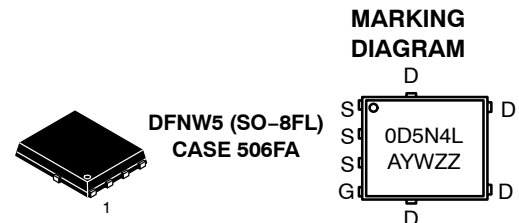

0D5N4L = Specific Device Code
 A = Assembly Location
 Y = Year
 W = Work Week
 ZZ = Lot Traceability

ORDERING INFORMATION

See detailed ordering, marking and shipping information in the package dimensions section on page 5 of this data sheet.

NTMFS0D5N04XL

THERMAL CHARACTERISTICS

Parameter	Symbol	Value	Unit
Thermal Resistance, Junction-to-Case – Steady State (Note 2)	$R_{\theta JC}$	0.77	°C/W
Thermal Resistance, Junction-to-Ambient – Steady State (Note 2)	$R_{\theta JA}$	38	

ELECTRICAL CHARACTERISTICS ($T_J = 25^\circ\text{C}$ unless otherwise specified)

Parameter	Symbol	Test Condition	Min	Typ	Max	Unit
OFF CHARACTERISTICS						
Drain-to-Source Breakdown Voltage	$V_{(BR)DSS}$	$V_{GS} = 0\text{ V}, I_D = 1\text{ mA}$	40			V
Drain-to-Source Breakdown Voltage Temperature Coefficient	$\Delta V_{(BR)DSS} / \Delta T_J$	$I_D = 1\text{ mA}$, referenced to 25°C		16.5		mV/°C
Zero Gate Voltage Drain Current	I_{DSS}	$V_{GS} = 0\text{ V}, V_{DS} = 40\text{ V}$	$T_J = 25^\circ\text{C}$		10	μA
			$T_J = 125^\circ\text{C}$		100	
Gate-to-Source Leakage Current	I_{GSS}	$V_{DS} = 0\text{ V}, V_{GS} = 20\text{ V}$			100	nA

ON CHARACTERISTICS

Drain-to-Source On Resistance	$R_{DS(on)}$	$V_{GS} = 10\text{ V}, I_D = 50\text{ A}, T_J = 25^\circ\text{C}$		0.39	0.49	m Ω
		$V_{GS} = 4.5\text{ V}, I_D = 50\text{ A}, T_J = 25^\circ\text{C}$		0.54	0.78	
Gate Threshold Voltage	$V_{GS(TH)}$	$V_{GS} = V_{DS}, I_D = 330\text{ }\mu\text{A}, T_J = 25^\circ\text{C}$	1.3		2.2	V
Gate Threshold Voltage Temperature Coefficient	$\Delta V_{GS(TH)} / \Delta T_J$	$V_{GS} = V_{DS}, I_D = 330\text{ }\mu\text{A}$		-5.35		mV/°C
Forward Transconductance	g_{FS}	$V_{DS} = 5\text{ V}, I_D = 50\text{ A}$		277		S

CHARGES, CAPACITANCES & GATE RESISTANCE

Input Capacitance	C_{ISS}	$V_{GS} = 0\text{ V}, V_{DS} = 20\text{ V}, f = 1\text{ MHz}$		9444		pF
Output Capacitance	C_{OSS}			2468		
Reverse Transfer Capacitance	C_{RSS}			38		
Output Charge	Q_{OSS}	$V_{GS} = 0\text{ V}, V_{DS} = 20\text{ V}$		95		nC
Total Gate Charge	$Q_{G(TOT)}$	$V_{GS} = 4.5\text{ V}, V_{DS} = 20\text{ V}; I_D = 50\text{ A}$		57		
Total Gate Charge	$Q_{G(TOT)}$	$V_{GS} = 10\text{ V}, V_{DS} = 20\text{ V}; I_D = 50\text{ A}$		127		
Threshold Gate Charge	$Q_{G(TH)}$			15		
Gate-to-Source Charge	Q_{GS}			27		
Gate-to-Drain Charge	Q_{GD}			9		
Gate Plateau Voltage	V_{GP}			2.8		
Gate Resistance	R_G	$f = 1\text{ MHz}$		0.48		

SWITCHING CHARACTERISTICS (Note 4)

Turn-On Delay Time	$t_{d(ON)}$	Resistive Load, $V_{GS} = 0/10\text{ V}, V_{DS} = 20\text{ V},$ $I_D = 50\text{ A}, R_G = 2.5\text{ }\Omega$		11		ns
Rise Time	t_r			10		
Turn-Off Delay Time	$t_{d(OFF)}$			55		
Fall Time	t_f			24		

DIODE CHARACTERISTICS

Forward Diode Voltage	V_{SD}	$V_{GS} = 0\text{ V}, I_S = 50\text{ A}$	$T_J = 25^\circ\text{C}$		0.78	1.2	V
			$T_J = 125^\circ\text{C}$		0.63		
Reverse Recovery Time	t_{RR}	$V_{GS} = 0\text{ V}, V_{DS} = 20\text{ V},$ $di_S/dt = 300\text{ A}/\mu\text{s}, I_S = 50\text{ A}$			40.5		ns
Charge Time	t_a				22.2		
Discharge Time	t_b				18.3		
Reverse Recovery Charge	Q_{RR}				108		

Product parametric performance is indicated in the Electrical Characteristics for the listed test conditions, unless otherwise noted. Product performance may not be indicated by the Electrical Characteristics if operated under different conditions.

4. Switching characteristics are independent of operating junction temperatures.

NTMFS0D5N04XL

TYPICAL CHARACTERISTICS

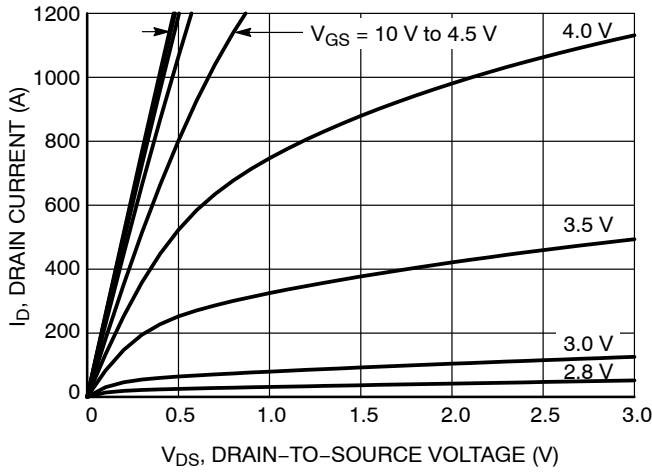

Figure 1. On-Region Characteristics

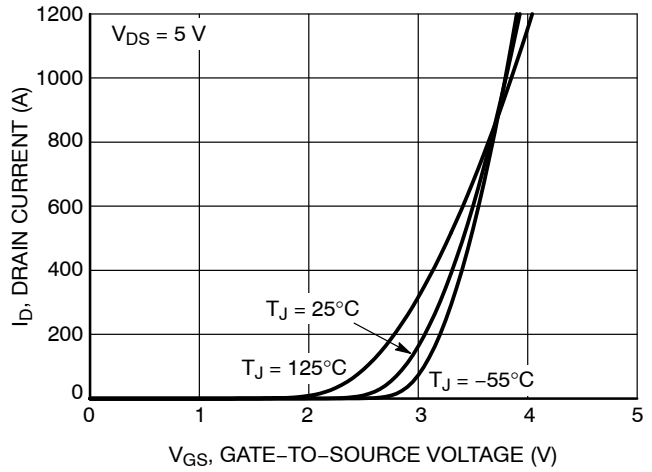

Figure 2. Transfer Characteristics

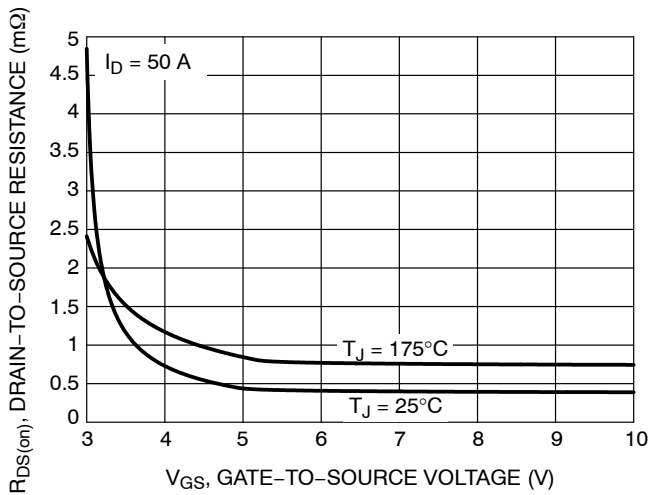

Figure 3. On-Resistance vs. Gate-to-Source Voltage

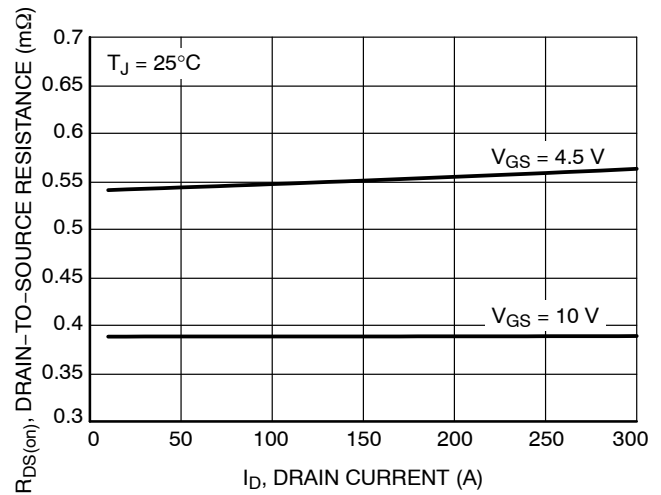

Figure 4. On-Resistance vs. Drain Current and Gate Voltage

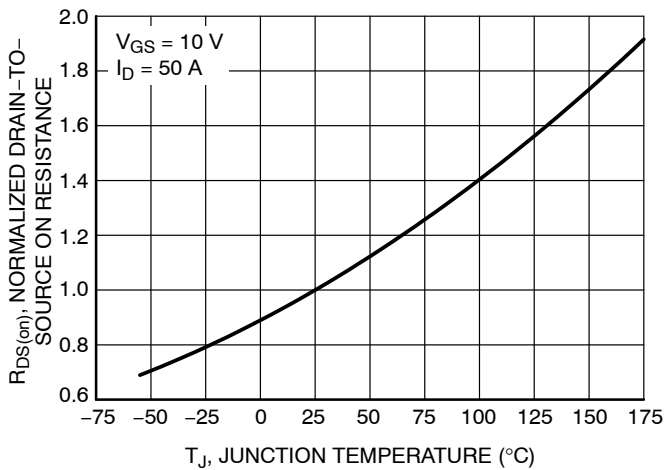

Figure 5. On-Resistance Variation with Temperature

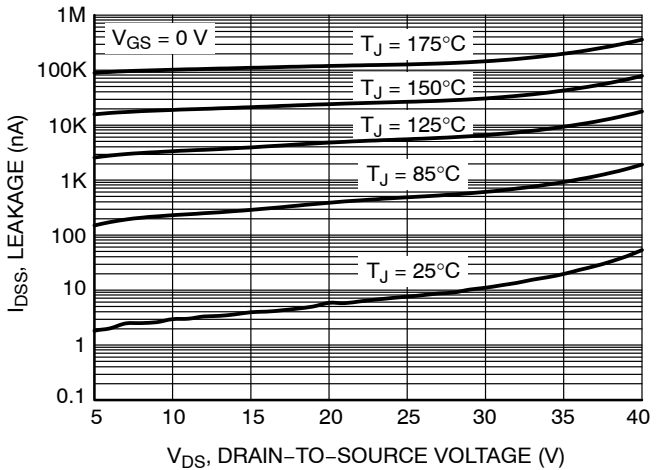

Figure 6. Drain-to-Source Leakage Current vs. Voltage

NTMFS0D5N04XL

TYPICAL CHARACTERISTICS

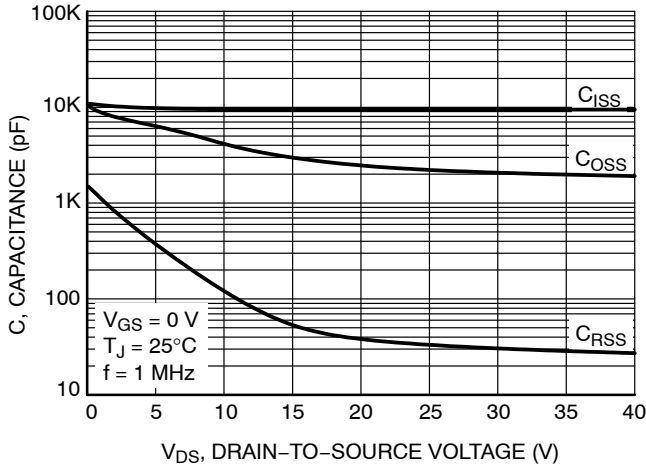

Figure 7. Capacitance Variation

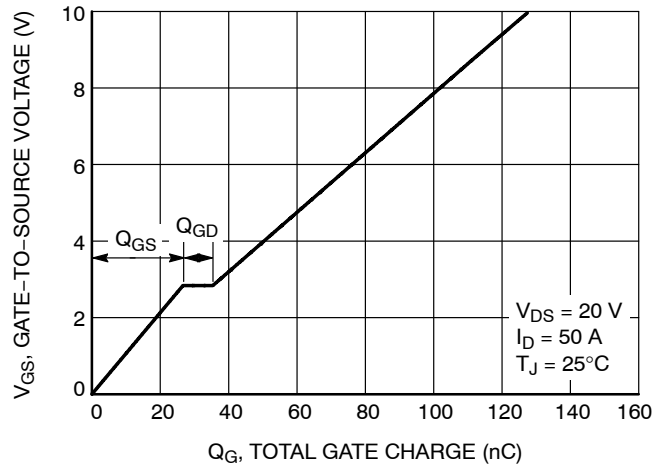

Figure 8. Gate-to-Source and Drain-to-Source Voltage vs. Total Charge

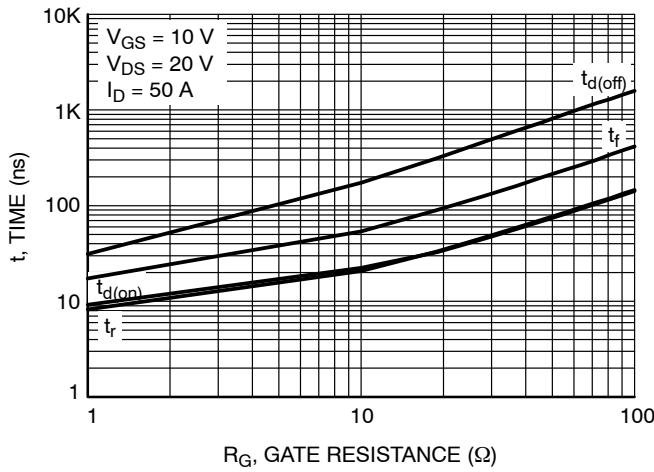

Figure 9. Resistive Switching Time Variation vs. Gate Resistance

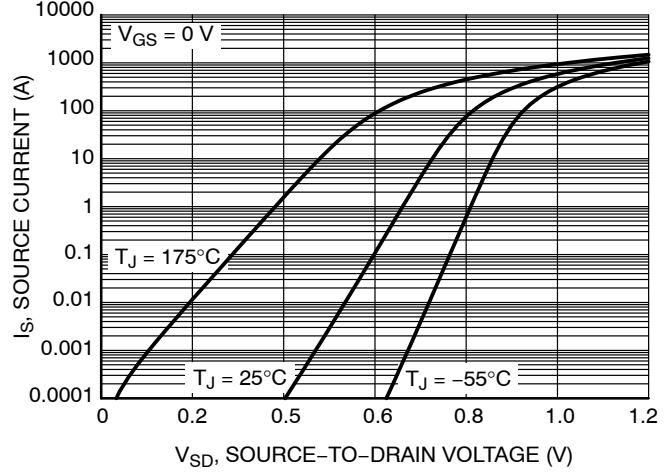

Figure 10. Diode Forward Voltage vs. Current

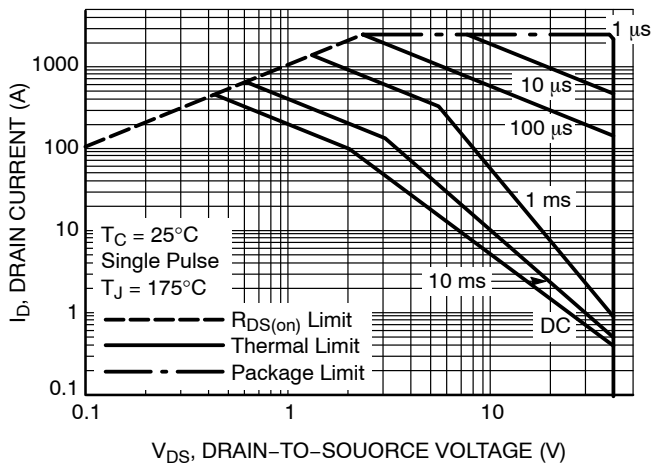

Figure 11. Safe Operating Area (SOA)

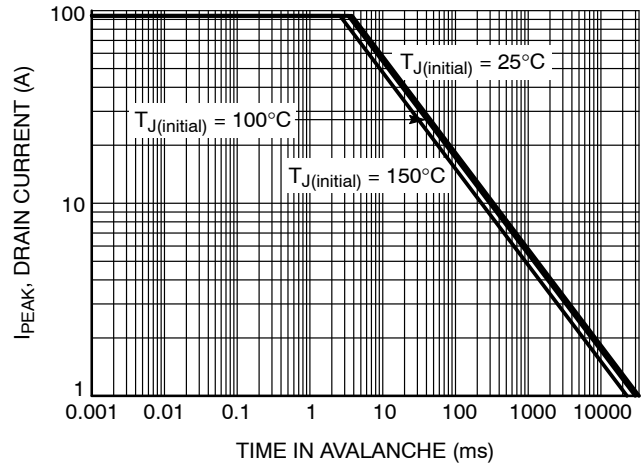

Figure 12. Avalanche Current vs. Pulse Time (UIS)

NTMFS0D5N04XL

TYPICAL CHARACTERISTICS

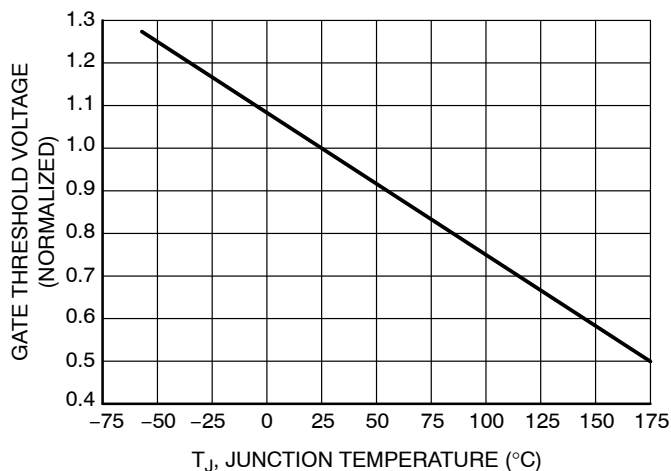

Figure 13. Gate Threshold Voltage vs. Junction Temperature

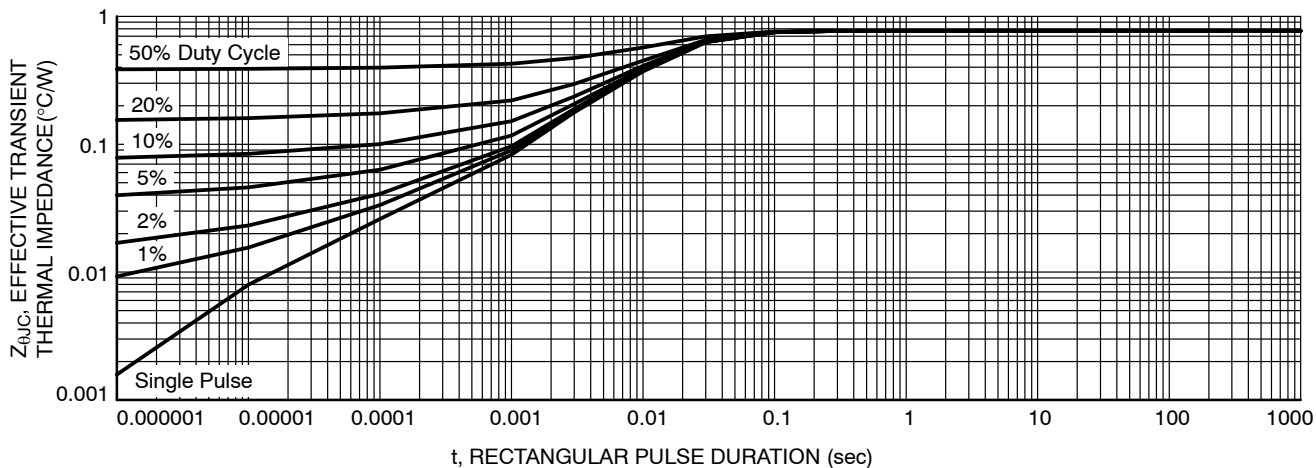
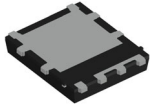

Figure 14. Thermal Characteristics

DEVICE ORDERING INFORMATION

Device	Marking	Package	Shipping†
NTMFS0D5N04XLT1G	0D5N4L	DFNW5 (Pb-Free)	1500 / Tape & Reel

†For information on tape and reel specifications, including part orientation and tape sizes, please refer to our Tape and Reel Packaging Specifications Brochure, BRD8011/D.



DFN5 5.00x5.90x1.00, 1.27P
CASE 506FA
ISSUE A

DATE 03 OCT 2024

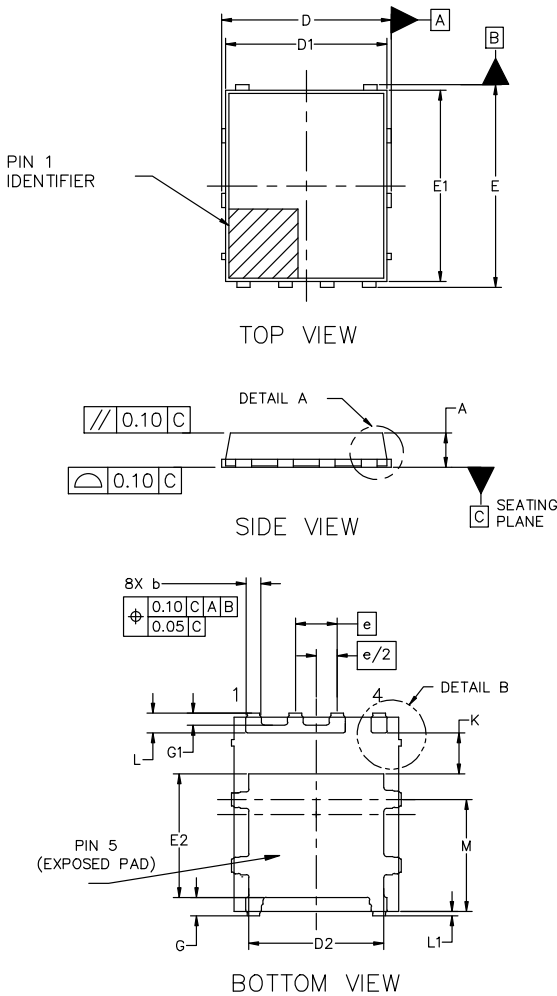

NOTES:

1. DIMENSIONING AND TOLERANCING PER ASME Y14.5M, 2018.
2. CONTROLLING DIMENSION: MILLIMETERS.
3. DIMENSIONS D1 AND E1 DO NOT INCLUDE MOLD FLASH, PROTRUSIONS, OR GATE BURRS.

MILLIMETERS			
DIM	MIN	NOM	MAX
A	0.90	1.00	1.10
A1	0.00	---	0.05
b	0.33	0.41	0.51
c	0.23	0.28	0.33
D	5.00	5.15	5.30
D1	4.80	5.00	5.20
D2	3.90	4.10	4.30
E	6.00	6.15	6.30
E1	5.70	5.90	6.10
E2	3.55	3.75	3.95
e	1.27 BSC		
G	0.50	0.55	0.70
G1	0.26	0.36	0.46
k	1.10	1.25	1.40
L	0.50	0.60	0.70
L1	0.150 REF		
M	3.00	3.40	3.80
θ	0°	---	12°

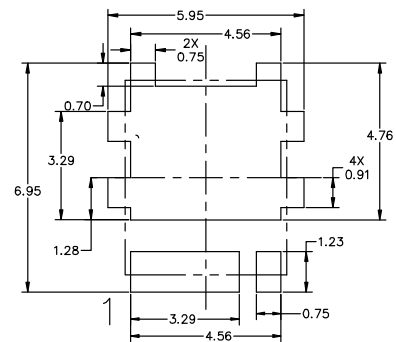

RECOMMENDED MOUNTING FOOTPRINT

*For additional information on our Pb-Free strategy and soldering details, please download the onsemi Soldering and Mounting Techniques Reference Manual, SOLDERRM/D.

GENERIC MARKING DIAGRAM*

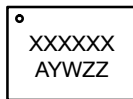

- XXXX = Specific Device Code
- A = Assembly Location
- Y = Year
- W = Work Week
- ZZ = Assembly Lot Code

*This information is generic. Please refer to device data sheet for actual part marking. Pb-Free indicator, "G" or microdot "•", may or may not be present. Some products may not follow the Generic Marking.

DOCUMENT NUMBER:	98AON21323H	Electronic versions are uncontrolled except when accessed directly from the Document Repository. Printed versions are uncontrolled except when stamped "CONTROLLED COPY" in red.
DESCRIPTION:	DFN5 5.00x5.90x1.00, 1.27P	PAGE 1 OF 1

onsemi and ONSEMI are trademarks of Semiconductor Components Industries, LLC dba onsemi or its subsidiaries in the United States and/or other countries. onsemi reserves the right to make changes without further notice to any products herein. onsemi makes no warranty, representation or guarantee regarding the suitability of its products for any particular purpose, nor does onsemi assume any liability arising out of the application or use of any product or circuit, and specifically disclaims any and all liability, including without limitation special, consequential or incidental damages. onsemi does not convey any license under its patent rights nor the rights of others.

onsemi, **Onsemi**, and other names, marks, and brands are registered and/or common law trademarks of Semiconductor Components Industries, LLC dba "**onsemi**" or its affiliates and/or subsidiaries in the United States and/or other countries. **onsemi** owns the rights to a number of patents, trademarks, copyrights, trade secrets, and other intellectual property. A listing of **onsemi**'s product/patent coverage may be accessed at www.onsemi.com/site/pdf/Patent-Marking.pdf. **onsemi** reserves the right to make changes at any time to any products or information herein, without notice. The information herein is provided "as-is" and **onsemi** makes no warranty, representation or guarantee regarding the accuracy of the information, product features, availability, functionality, or suitability of its products for any particular purpose, nor does **onsemi** assume any liability arising out of the application or use of any product or circuit, and specifically disclaims any and all liability, including without limitation special, consequential or incidental damages. Buyer is responsible for its products and applications using **onsemi** products, including compliance with all laws, regulations and safety requirements or standards, regardless of any support or applications information provided by **onsemi**. "Typical" parameters which may be provided in **onsemi** data sheets and/or specifications can and do vary in different applications and actual performance may vary over time. All operating parameters, including "Typicals" must be validated for each customer application by customer's technical experts. **onsemi** does not convey any license under any of its intellectual property rights nor the rights of others. **onsemi** products are not designed, intended, or authorized for use as a critical component in life support systems or any FDA Class 3 medical devices or medical devices with a same or similar classification in a foreign jurisdiction or any devices intended for implantation in the human body. Should Buyer purchase or use **onsemi** products for any such unintended or unauthorized application, Buyer shall indemnify and hold **onsemi** and its officers, employees, subsidiaries, affiliates, and distributors harmless against all claims, costs, damages, and expenses, and reasonable attorney fees arising out of, directly or indirectly, any claim of personal injury or death associated with such unintended or unauthorized use, even if such claim alleges that **onsemi** was negligent regarding the design or manufacture of the part. **onsemi** is an Equal Opportunity/Affirmative Action Employer. This literature is subject to all applicable copyright laws and is not for resale in any manner.

ADDITIONAL INFORMATION

TECHNICAL PUBLICATIONS:

Technical Library: www.onsemi.com/design/resources/technical-documentation
onsemi Website: www.onsemi.com

ONLINE SUPPORT: www.onsemi.com/support

For additional information, please contact your local Sales Representative at www.onsemi.com/support/sales